



- Dental
- Surgical
- Veterinary
- Orthopaedic
- Electro

H&H

Impex

Samar Hussain

03142500475

03322901615

samarhussain1@hotmail.com



www.handhimpex.com

Diagnostic



J-12-024



J-12-025



J-12-026



J-12-023



Universal
J-12-022



J-12-027

Otoscope Set, Consisting of battery handle
(Without batteries), 3 ear specula,
1 bulb in velvet lined case



Ziegler
J-12-028 90 mm dia
J-12-029 100 mm dia



J-12-030 90 mm dia
J-12-031 100 mm dia

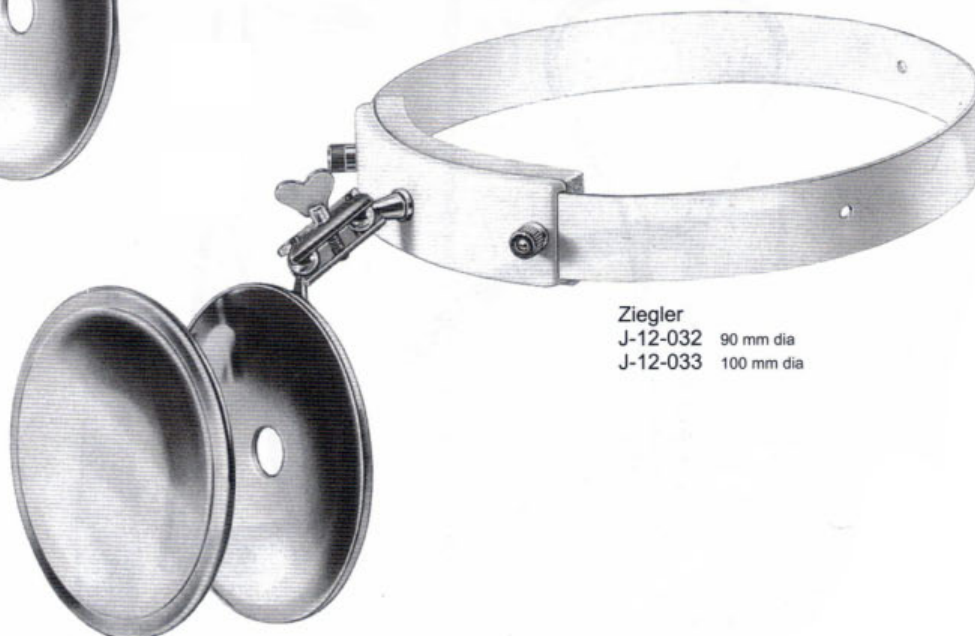

Ziegler
J-12-032 90 mm dia
J-12-033 100 mm dia

Pin Wheel
for neurological
examination



Wartenberg
J-12-012
18 cm, 7"



Townley
J-12-015
10 cm / 4"



Bertillon
J-12-016

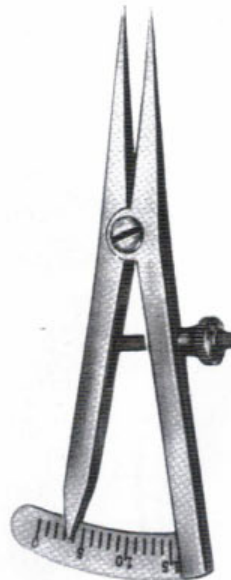

Castroviejo-Caliper
J-12-017



Moeltgen
J-12-019

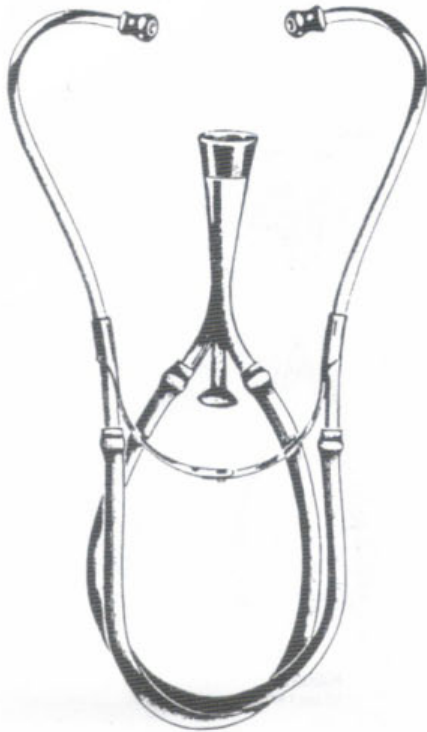

Ford / skinner
SV-0001-00
C. P. folding frames
With Thumb Rest



Sprague Bowle
SV-0002-00
C. P. folding frames



Taylor
J-12-001
18 cm
Plastic CP & SS



Buck
J-12-003
18 cm / 7"
with needle
and brush



J-12-003 A
spare rubber, large
J-12-003 B
spare rubber, small



Troemner
J-12-008
24.5 cm / 9 1/2"
Available in CP + SS



Dia 50 mm
Heavy

National Hospital
J-12-011 A
33.5 cm / 14"
Plastic handle



Dia 42 mm

Babinski
J-12-010
Plastic handle

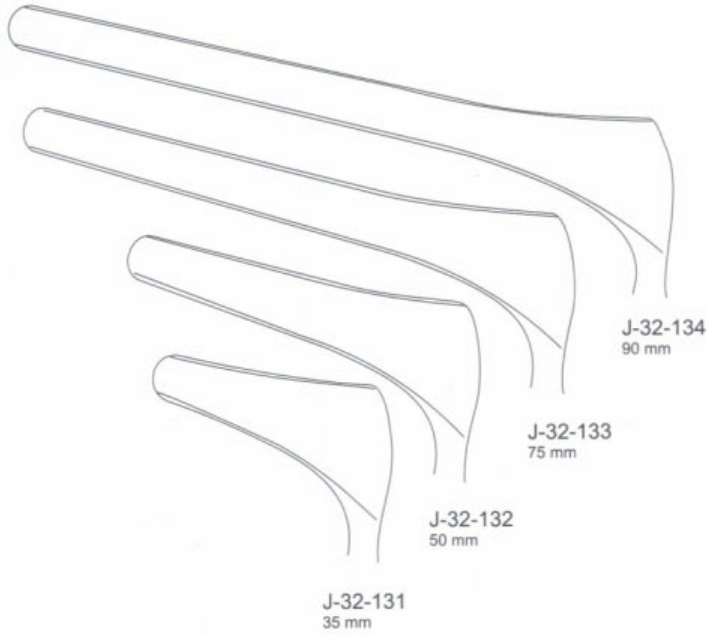

Killian
13 cm / 5"



Magill
Catheter introducing forceps

SV-0061-20
20 cm

SV-0062-23
23 cm

SV-0063-25
25 cm



Mcintosh
J-13-001
Laryngoscope set
J-13-001 F
Fiber Optic Laryngoscope set

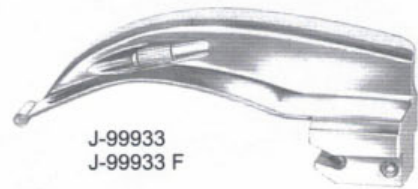

J-99933
J-99933 F



J-99934
J-99934 F

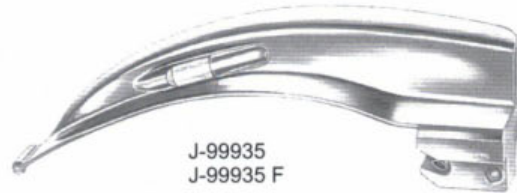

J-99935
J-99935 F



J-99936
J-99936 F

Note :-
Item numbers with "F" are for Fiber Optic.



Miller
J-13-002
Laryngoscope set
J-13-002 F
Fiber Optic Laryngoscope set

J



J-99938
J-99938 F



J-99939
J-99939 F



J-99940
J-99940 F



J-99941
J-99941 F



J-99942
J-99942 F

Note :-
Item numbers with "F" are for Fiber Optic.

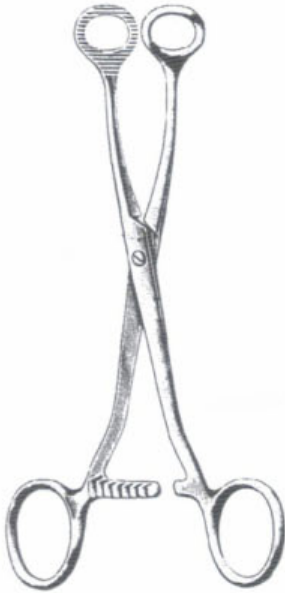

Collin
J-33-500
16 cm / 6 1/4"

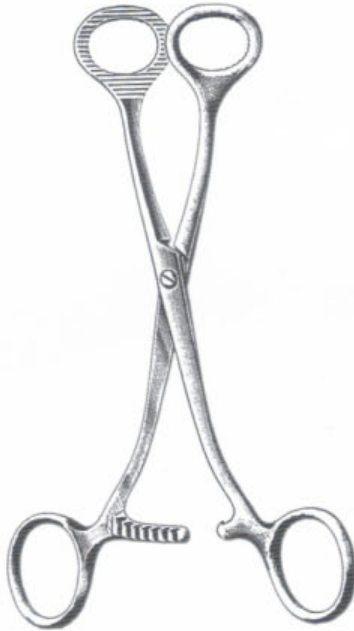

Collin
J-33-509 16 cm / 6 1/4"
J-33-510 17 cm / 6 3/4"
J-33-520 19 cm / 7 1/2"



Guy
J-33-530
19 cm / 7 1/2"



Mathieu
J-33-540
19 cm / 7 1/2"



Young
J-33-550
17 cm / 6 3/4"



J-33-560



Clock
SV-1075-23
23 cm
Uterine Holding



Chevalier-Jackson

	Fig.
J-26-150	0
J-26-160	1
J-26-170	2
J-26-180	3
J-26-190	4
J-26-200	5
J-26-210	6
J-26-220	7
J-26-230	8
J-26-231	9



Luer

	Fig.
J-26-240	0
J-26-250	1
J-26-260	2
J-26-270	3
J-26-280	4
J-26-290	5
J-26-300	6
J-26-310	7
J-26-320	8
J-26-321	9

International Scale

Diameter		Length of outer tube N
Fig . 0	④	45 mm
Fig . 1	⑤	50 mm
Fig . 2	⑥	55 mm
Fig . 3	⑦	60 mm
Fig . 4	⑧	65 mm
Fig . 5	⑨	70 mm
Fig . 6	⑩	75 mm
Fig . 7	⑪	80 mm
Fig . 8	⑫	85 mm
Fig . 9	⑬	90 mm

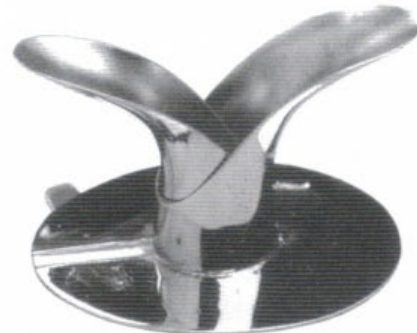

SV-1323-30 18 mm id 22 mm od
 SV-1324-40 22 mm id 28 mm od
 Tracheotomy Tube, Chrome Plated

"id" is for inner diameter
 "od" is for outer diameter

General Surgery

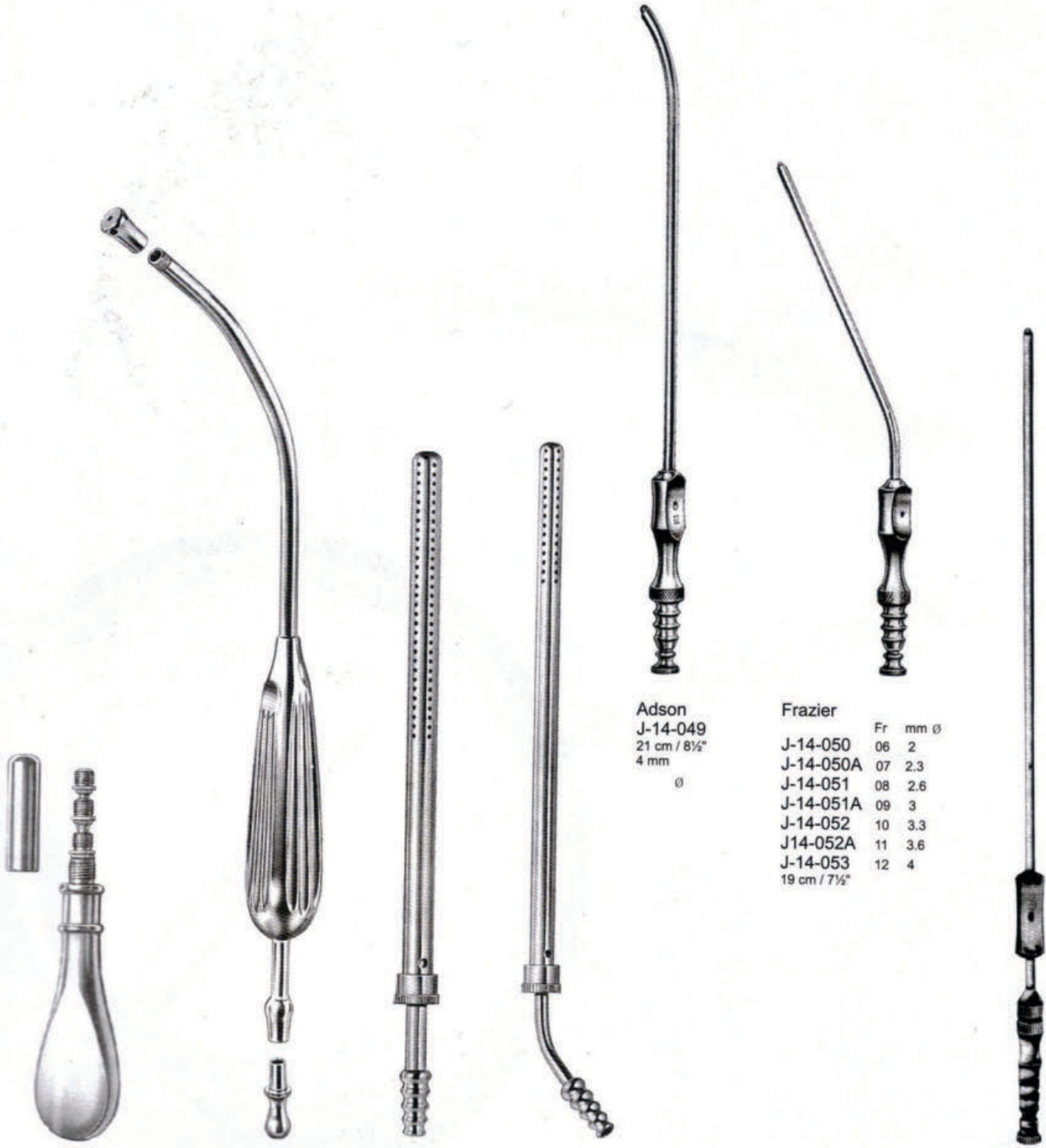

Universal
J-14-001
set of 3 pieces
J-14-002
set of 4 pieces

Yankauer
J-14-037
23 cm / 9"
J-14-037A
27 cm / 11"

Poole
J-14-039
22 cm / 8 3/4" 10 mm Ø
(Fr. 30)

Poole
J-14-040
22 cm / 8 3/4" 8 mm Ø
(Fr. 23)

Adson
J-14-049
21 cm / 8 1/2"
4 mm
Ø

Frazier

	Fr	mm Ø
J-14-050	06	2
J-14-050A	07	2.3
J-14-051	08	2.6
J-14-051A	09	3
J-14-052	10	3.3
J-14-052A	11	3.6
J-14-053	12	4

19 cm / 7 1/2"

Frazier
J-14-058 A
9 fr. 3 mm



Standard
J-15-063
No. 3
Solid



J-15-066
No. 3
Plastic



J-15-067
No. 3 L
Solid / Straight



Standard
J-15-069
No. 4
Solid



J-15-070
No. 4
Plastic



J-15-071
No. 4L
Solid Straight



J-15-073
No. 7
Solid



J-15-074
No. 7K
Solid

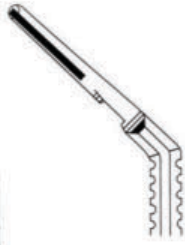

J-15-068
Solid / Angled

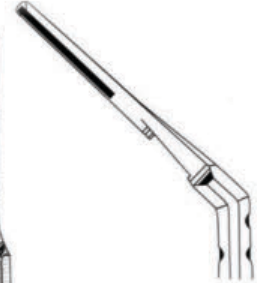

J-15-072
Solid Angled

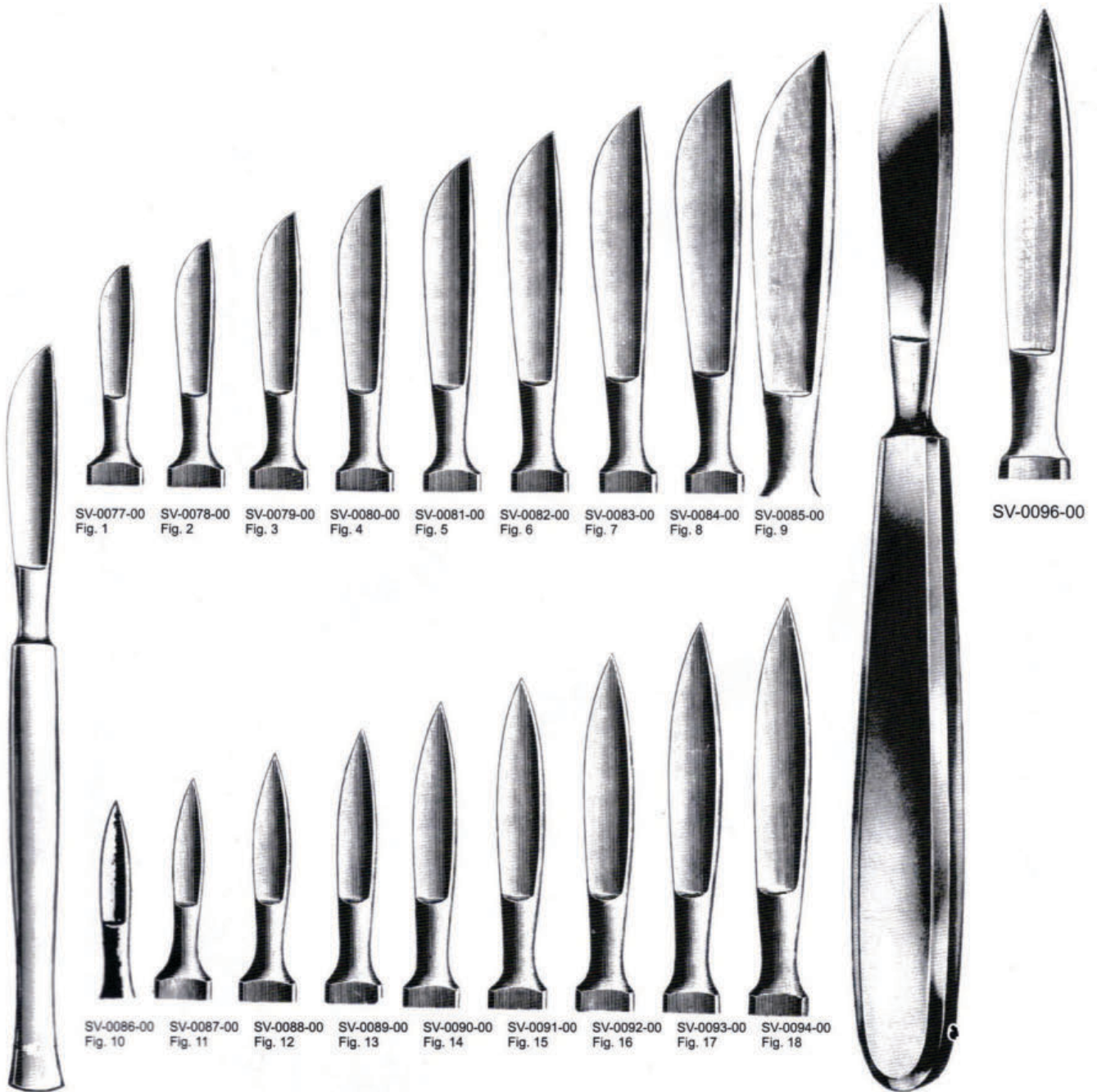

SV-0077-00
Fig. 1

SV-0078-00
Fig. 2

SV-0079-00
Fig. 3

SV-0080-00
Fig. 4

SV-0081-00
Fig. 5

SV-0082-00
Fig. 6

SV-0083-00
Fig. 7

SV-0084-00
Fig. 8

SV-0085-00
Fig. 9

SV-0096-00

SV-0086-00
Fig. 10

SV-0087-00
Fig. 11

SV-0088-00
Fig. 12

SV-0089-00
Fig. 13

SV-0090-00
Fig. 14

SV-0091-00
Fig. 15

SV-0092-00
Fig. 16

SV-0093-00
Fig. 17

SV-0094-00
Fig. 18

Standard
Solid Forged

Langenbeck
SV-0095-00
Hollow handle



Standard	
J-22-001	10.5 cm / 4 1/4"
J-22-002	11.5 cm / 4 1/2"
J-22-003	13.0 cm / 5"
J-22-004	14.5 cm / 5 1/2"
J-22-005	15.5 cm / 6"
J-22-006	16.5 cm / 6 1/2"
J-22-007	18.5 cm / 7 1/4"
J-22-008	20.0 cm / 8"

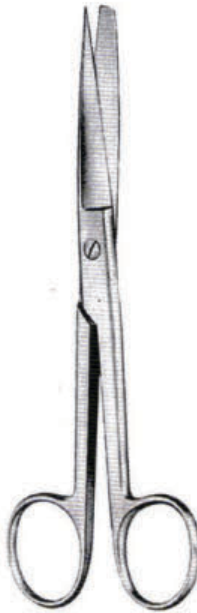

Standard	
J-22-009	10.5 cm / 4 1/4"
J-22-010	11.5 cm / 4 1/2"
J-22-011	13.0 cm / 5"
J-22-012	14.5 cm / 5 1/2"
J-22-013	15.5 cm / 6"
J-22-014	16.5 cm / 6 1/2"
J-22-015	18.5 cm / 7 1/4"
J-22-016	20.0 cm / 8"



Standard	
J-22-017	10.5 cm / 4 1/4"
J-22-018	11.5 cm / 4 1/2"
J-22-019	13.0 cm / 5"
J-22-020	14.5 cm / 5 1/2"
J-22-021	15.5 cm / 6"
J-22-022	16.5 cm / 6 1/2"
J-22-023	18.5 cm / 7 1/4"
J-22-024	20.0 cm / 8"



Standard	
J-22-025	11.5 cm / 4 1/2"
J-22-026	13.0 cm / 5"
J-22-027	14.5 cm / 5 1/2"
J-22-028	15.5 cm / 6"
J-22-029	16.5 cm / 6 1/2"
J-22-030	18.5 cm / 7 1/4"
J-22-031	20.0 cm / 8"



Standard	
J-22-032	11.5 cm / 4 1/2"
J-22-033	13.0 cm / 5"
J-22-034	14.5 cm / 5 1/2"
J-22-035	15.5 cm / 6"
J-22-036	16.5 cm / 6 1/2"
J-22-037	18.5 cm / 7 1/4"
J-22-038	20.0 cm / 8"

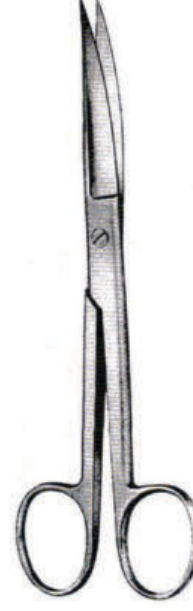

Standard	
J-22-039	11.5 cm / 4 1/2"
J-22-040	13.0 cm / 5"
J-22-041	14.5 cm / 5 1/2"
J-22-042	15.5 cm / 6"
J-22-043	16.5 cm / 6 1/2"
J-22-044	18.5 cm / 7 1/4"
J-22-045	20.0 cm / 8"

Also available in micro tone.
One blade like knife and one ring Gold Plated
Same numbers but with the addition (A).

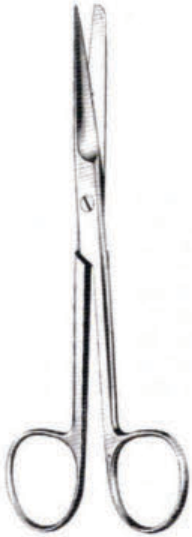

Deaver

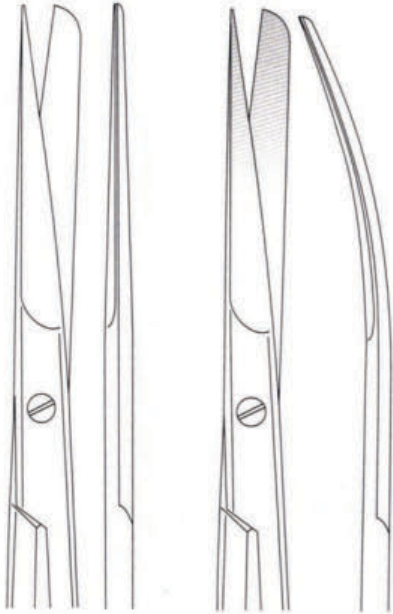

J-22-046 14 cm / 5½" J-22-047



Mayo

- J-22-100 14 cm / 5½"
- J-22-101 15 cm / 6"
- J-22-102 17 cm / 6¾"
- J-22-103 23 cm / 9"
- Straight

- J-22-104 14 cm / 5½"
- J-22-105 15 cm / 6"
- J-22-106 17 cm / 6¾"
- J-22-107 23 cm / 9"
- Curved

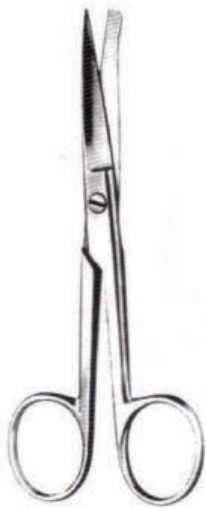

Incision
J-22-048 13 cm / 5"
J-22-049 14 cm / 5½"

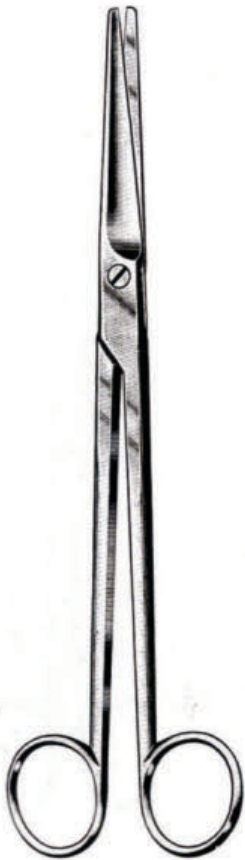

Mayo Harrington

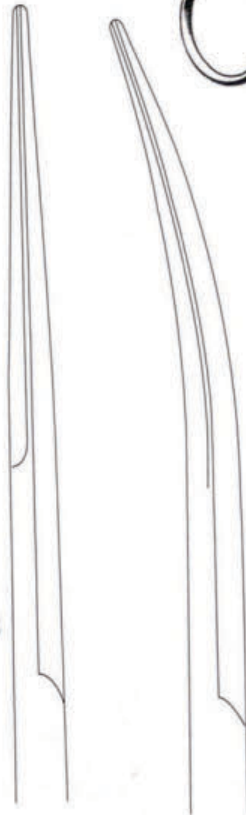

J-22-108 22.5 cm / 9" J-22-109
J-22-110 30 cm / 12" J-22-110A
Straight Curved

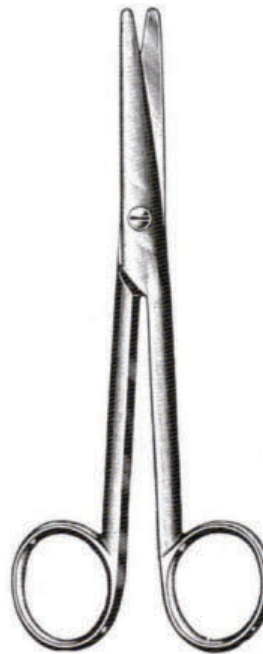

Mayo Stille

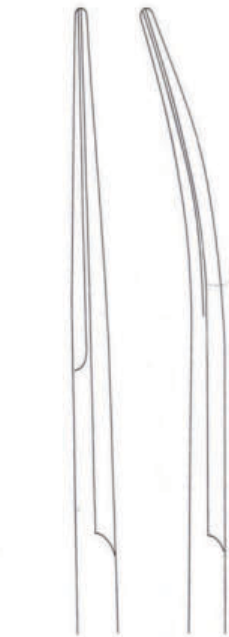

J-22-111 15 cm / 6" J-22-116
J-22-112 16 cm / 6¼" J-22-117
J-22-113 17 cm / 6¾" J-22-118
J-22-114 19 cm / 7½" J-22-119
J-22-115 21 cm / 8½" J-22-119A
Straight Curved

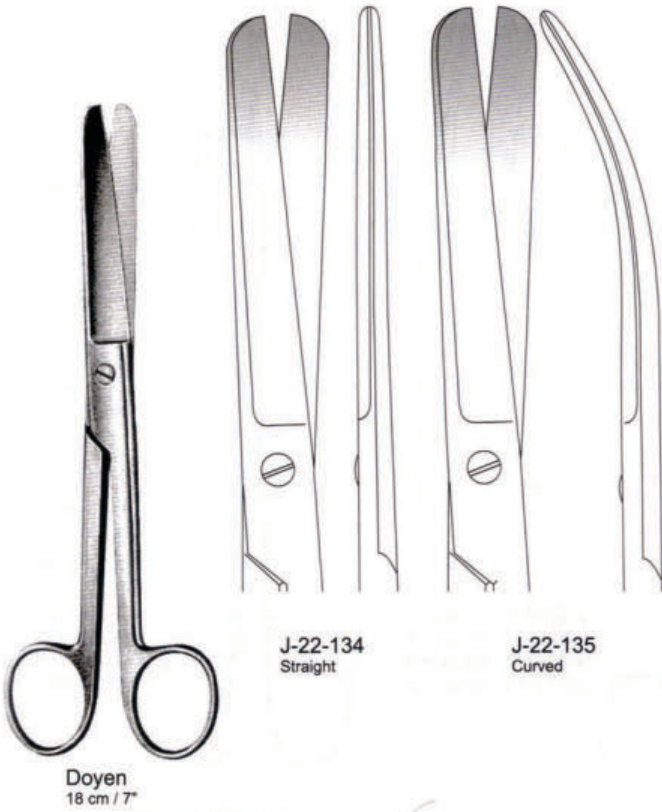

Doyen
18 cm / 7"

J-22-134
Straight

J-22-135
Curved

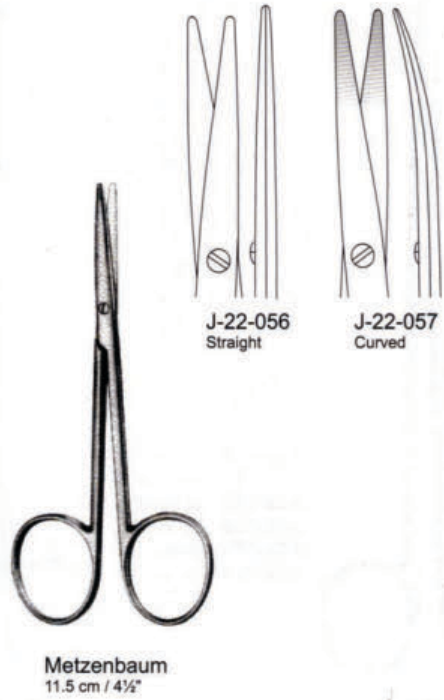

Metzenbaum
11.5 cm / 4½"

J-22-056
Straight

J-22-057
Curved



Metzenbaum
15 cm / 6"

J-22-058
Straight

J-22-059
Curved



Metzenbaum
14.5 cm / 5½"

J-22-060
J-22-061
J-22-062
Straight

J-22-063 Blunt / Blunt
J-22-064 Sharp / Blunt
J-22-065 Sharp / Sharp
Curved



Metzenbaum



- J-22-066 18 cm / 7"
- J-22-067 20 cm / 8"
- J-22-068 23 cm / 9"
- J-22-069 25 cm / 10"
- J-22-070 28 cm / 11"
- J-22-071 30 cm / 12"

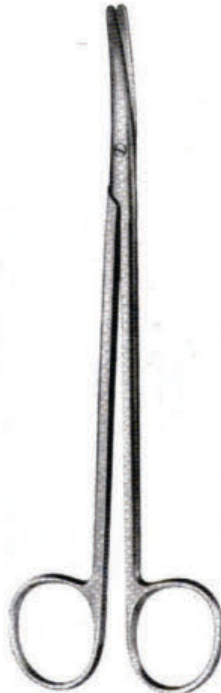

Metzenbaum



- J-22-072 18 cm / 7"
- J-22-073 20 cm / 8"
- J-22-074 23 cm / 9"
- J-22-075 25 cm / 10"
- J-22-076 28 cm / 11"
- J-22-077 30 cm / 12"

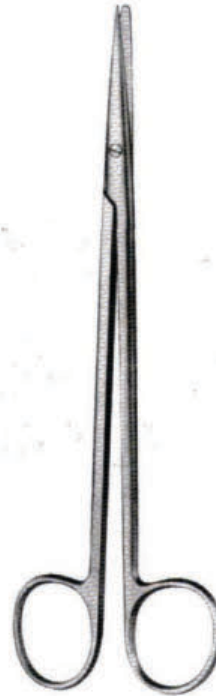

Metzenbaum-Nelson

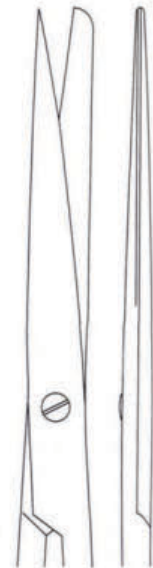

- J-22-078 18 cm / 7"
- J-22-079 20 cm / 8"
- J-22-080 23 cm / 9"
- J-22-081 25 cm / 10"
- J-22-082 28 cm / 11"
- J-22-083 30 cm / 12"

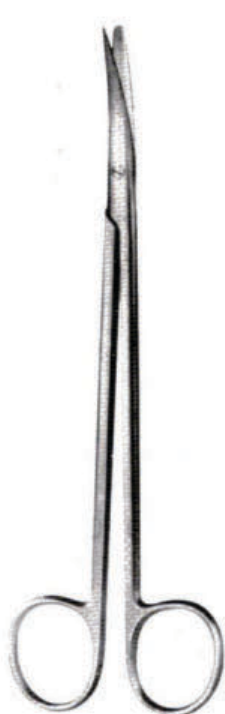

Metzenbaum-Nelson

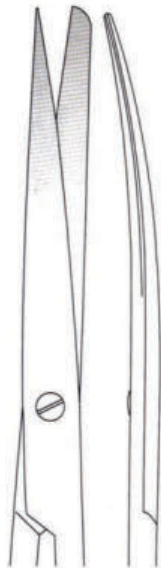

- J-22-084 18 cm / 7"
- J-22-085 20 cm / 8"
- J-22-086 23 cm / 9"
- J-22-087 25 cm / 10"
- J-22-088 28 cm / 11"
- J-22-089 30 cm / 12"

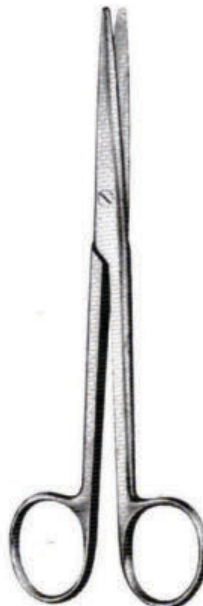

Lexer

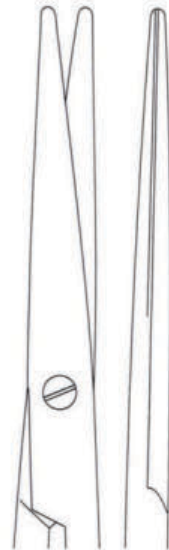

- J-22-151 16 cm / 6¼"
- J-22-152 21 cm / 8½"



- J-22-153 16 cm / 6¼"
- J-22-154 21 cm / 8½"



Metzenbaum-Fino
 J-22-155 14.5 cm / 5½"
 J-22-156 18 cm / 7"
 J-22-157 20 cm / 8"
 J-22-158 23 cm / 9"



Metzenbaum-Fino
 J-22-159 14.5 cm / 5½"
 J-22-160 18 cm / 7"
 J-22-161 20 cm / 8"
 J-22-162 23 cm / 9"



Metzenbaum-Fino
 J-22-163 14.5 cm / 5½"
 J-22-164 18 cm / 7"
 J-22-165 20 cm / 8"
 J-22-166 23 cm / 9"

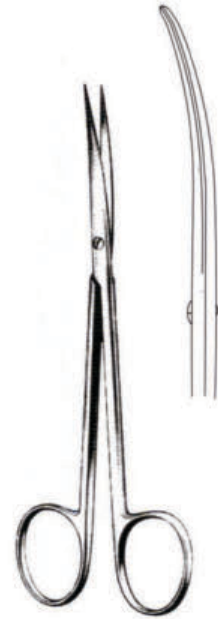

Metzenbaum-Fino
 J-22-167 14.5 cm / 5½"
 J-22-168 18 cm / 7"
 J-22-169 20 cm / 8"
 J-22-170 23 cm / 9"



Lexer-Fino
 J-22-171
 16 cm / 6¼"



Lexer-Fino
 J-22-172
 16 cm / 6¼"

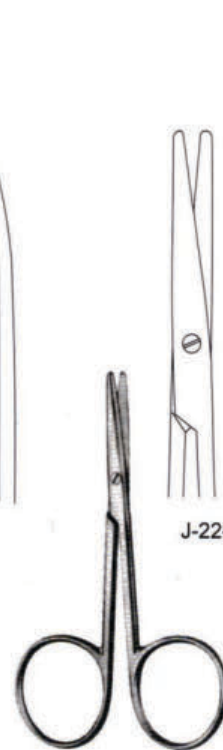

Lexer-Baby
 10 cm / 4"

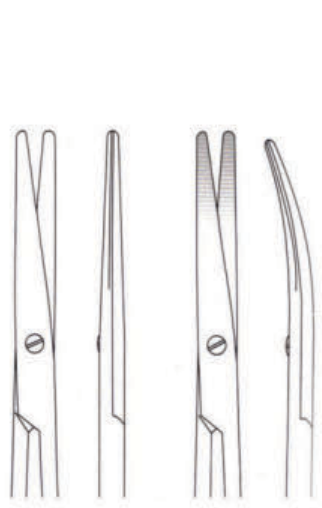

J-22-173

J-22-174

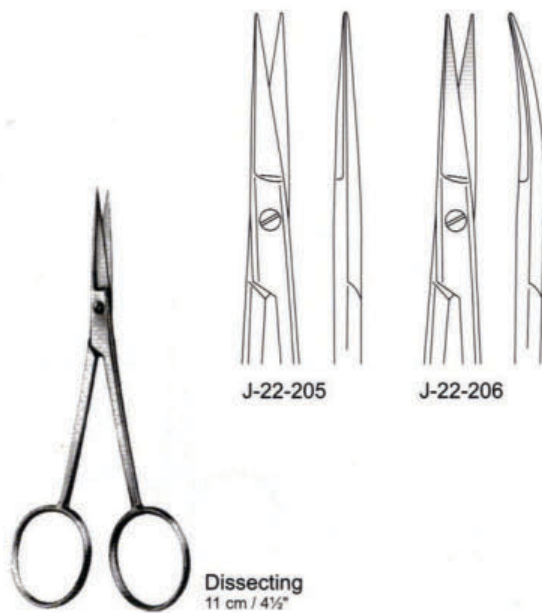
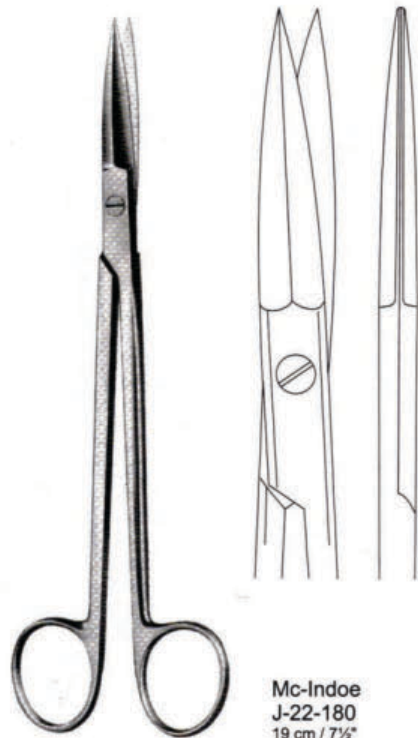



Iris-Fine

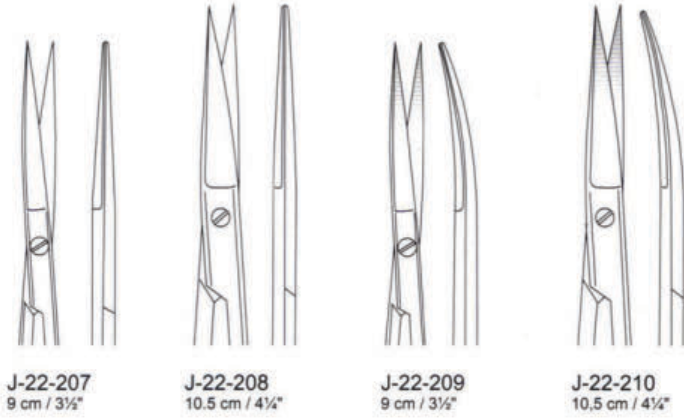

J-22-207
9 cm / 3½"

J-22-208
10.5 cm / 4¼"

J-22-209
9 cm / 3½"

J-22-210
10.5 cm / 4¼"



Iris
11.5 cm / 4½"

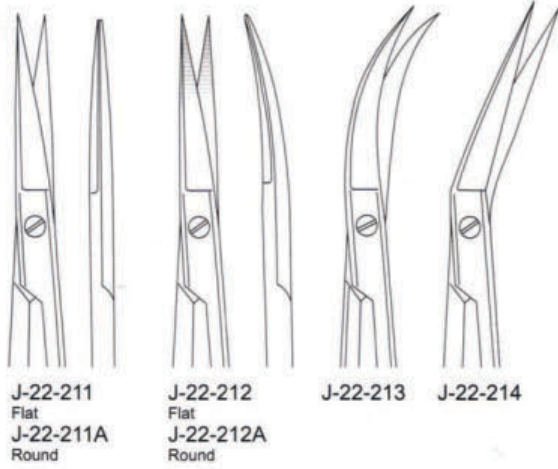

J-22-211
Flat
J-22-211A
Round

J-22-212
Flat
J-22-212A
Round

J-22-213 J-22-214

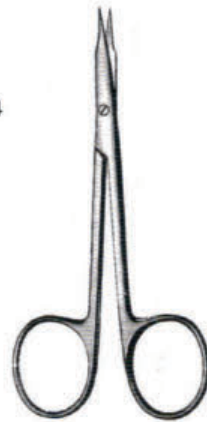

Steven
11 cm / 4½"



J-22-215

J-22-216

J-22-217

J-22-218



Strabismus
11.5 cm / 4½"

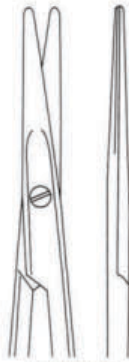

J-22-219



J-22-220



Kilner
11.5 cm / 4½"

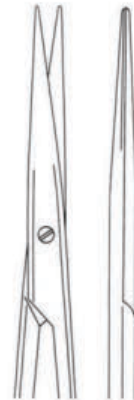

J-22-221



J-22-222



Spencer
J-22-223
9 cm / 3½"

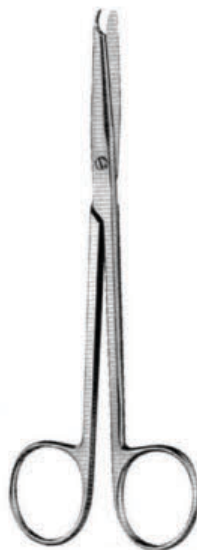

Spencer
J-22-224
13 cm / 5"

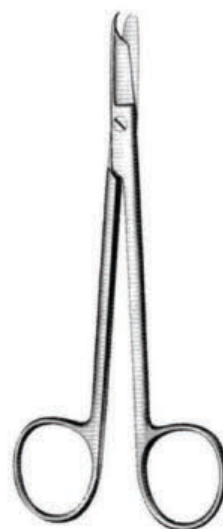

Littauer
J-22-225
14 cm / 5½"



Heath-Stitch
J-22-226
15 cm / 6"



Crown-Beebee



J-22-234
10 cm / 4"

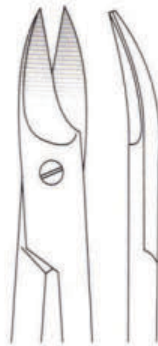

J-22-235
10 cm / 4"

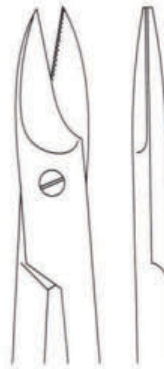

J-22-236
12 cm / 4 1/2"
1 blade saw edge



J-22-237
12 cm / 4 1/2"
1 blade saw edge



Lister



Jo-21-118 9 cm / 3 1/2"
Jo-21-119 11 cm / 4 1/2"
Jo-21-120 14 cm / 5 1/2"
Jo-21-121 16 cm / 6 1/4"
Jo-21-122 18 cm / 7"
Jo-21-123 20 cm / 8"



Universal Scissor
J-22-238
12 cm / 4 1/2"
Serrated

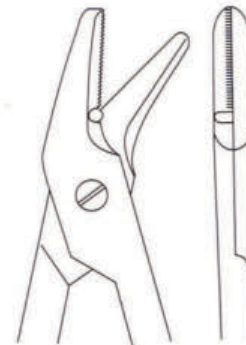



Standard

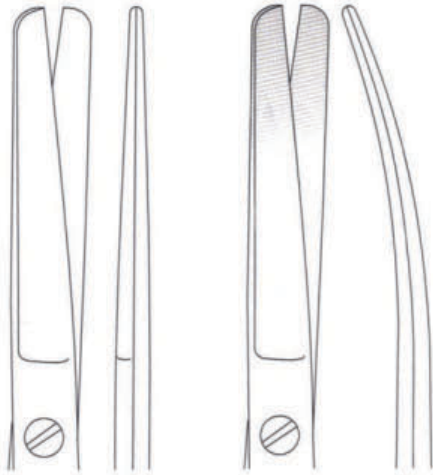

JT-22-600	14.5 cm / 5 3/4"	JT-22-603
JT-22-601	16 cm / 6 1/4"	JT-22-604
JT-22-602	18 cm / 7"	JT-22-605
Standard		Curved



Standard

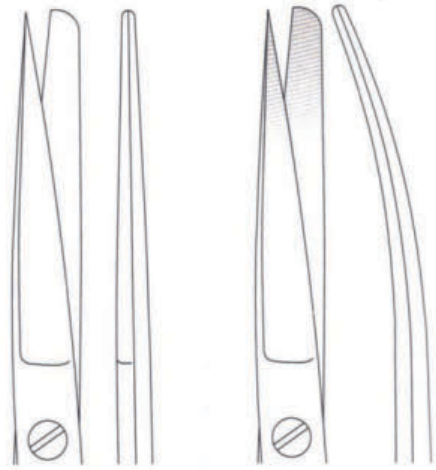

JT-22-606	14.5 cm / 5 3/4"	JT-22-609
JT-22-607	16 cm / 6 1/4"	JT-22-610
JT-22-608	18 cm / 7"	JT-22-611
Standard		Curved



Standard

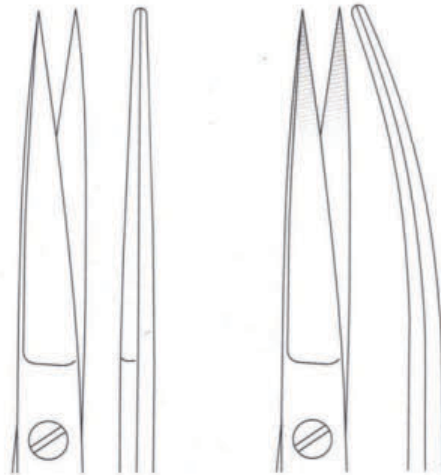

JT-22-612	14.5 cm / 5 3/4"	JT-22-615
JT-22-613	16 cm / 6 1/4"	JT-22-616
JT-22-614	18 cm / 7"	JT-22-617
Standard		Curved



Mayo

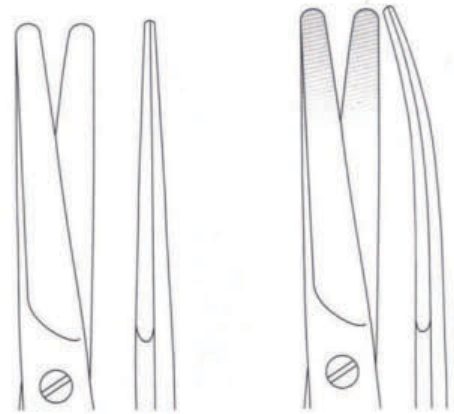

JT-22-618	14.5 cm / 5 3/4"	JT-22-621
JT-22-619	17 cm / 6 3/4"	JT-22-622
JT-22-620	23 cm / 9"	JT-22-623
Standard		Curved



JT-22-624
JT-22-625

15 cm / 6"
17 cm / 6 3/4"

JT-22-626
JT-22-627

Mayo-Stille



JT-22-628
JT-22-629

16 cm / 6 1/2"
21 cm / 8 1/4"

JT-22-630
JT-22-631

Lexer

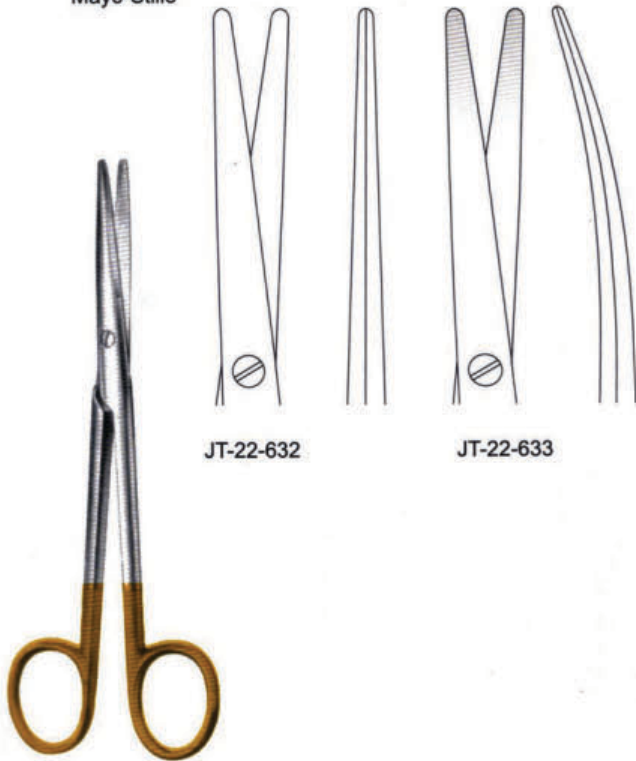

JT-22-632

JT-22-633

Mayo-Lexer
16 cm / 6 1/2"

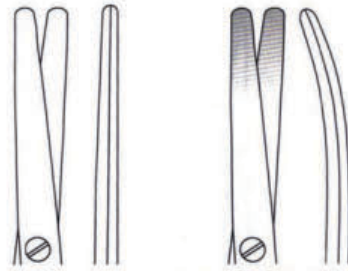

JT-22-634
JT-22-635

10 cm / 4"
12 cm / 4 3/4"

JT-22-636
JT-22-637

Metzenbaum



- JT-22-638 14.5 cm / 5 1/4"
- JT-22-639 18 cm / 7"
- JT-22-640 20 cm / 8"
- JT-22-641 23 cm / 9"
- JT-22-642 25 cm / 10"
- JT-22-643 28 cm / 11"
- JT-22-644 30 cm / 12"

Metzenbaum

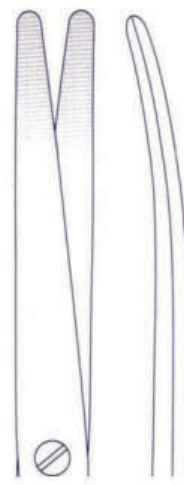

- JT-22-645 14.5 cm / 5 1/4"
- JT-22-646 18 cm / 7"
- JT-22-647 20 cm / 8"
- JT-22-648 23 cm / 9"
- JT-22-649 25 cm / 10"
- JT-22-650 28 cm / 11"
- JT-22-651 30 cm / 12"

Metzenbaum

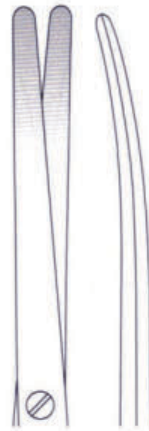
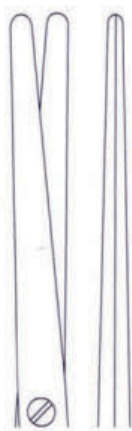
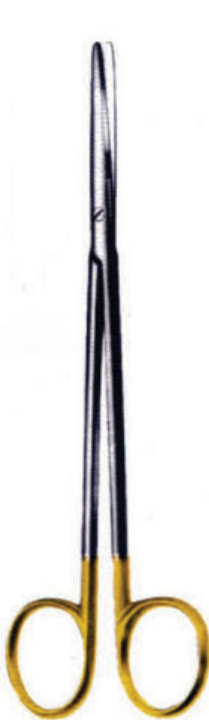

- | | |
|----------------------------|-----------|
| JT-22-652 14.5 cm / 5 3/4" | JT-22-659 |
| JT-22-653 18 cm / 7" | JT-22-660 |
| JT-22-654 20 cm / 8" | JT-22-661 |
| JT-22-655 23 cm / 9" | JT-22-662 |
| JT-22-656 25 cm / 10" | JT-22-663 |
| JT-22-657 28 cm / 11" | JT-22-664 |
| JT-22-658 30 cm / 12" | JT-22-665 |
| Straight | Curved |

Metzenbaum- Fino

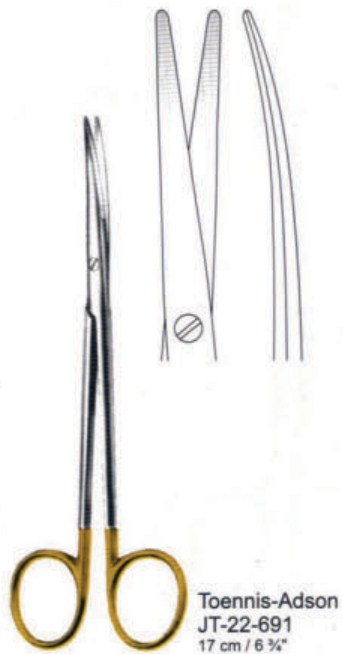
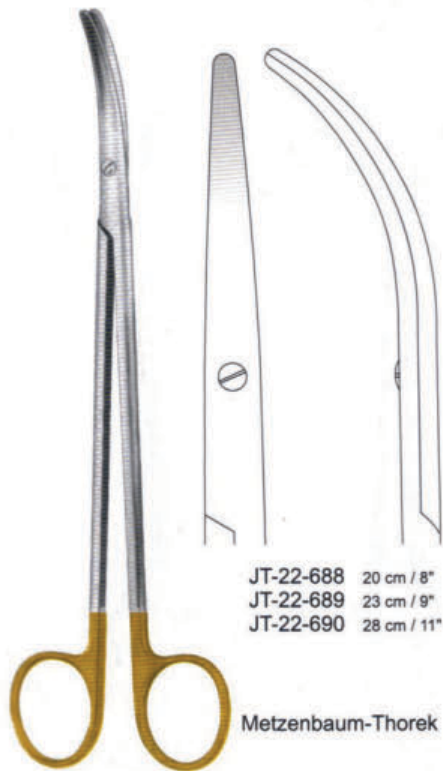

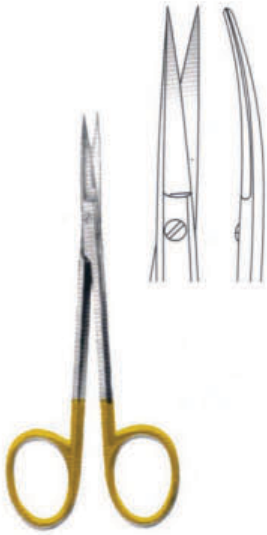

Iris
 JT-22-693 Straight
 JT-22-694 Curved
 11.5 cm , 4 1/2"

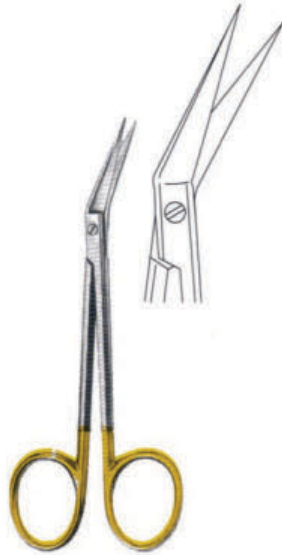

Iris
 JT-22-695 Straight
 JT-22-696A Curved
 13 cm , 5"

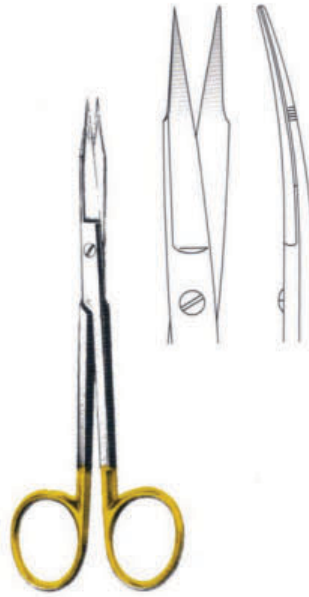

Goldman- Fox
 JT-22-697 Straight
 JT-22-698 Curved
 13 cm , 5"

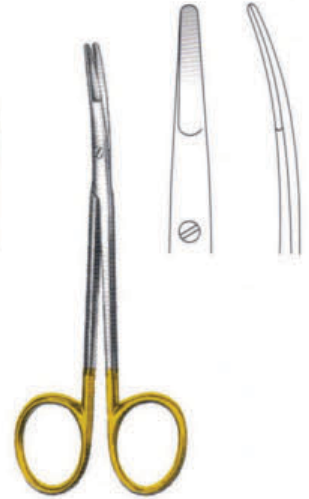

Ragnell (killner)
 JT-22-699
 12 Cm , 4 1/2"

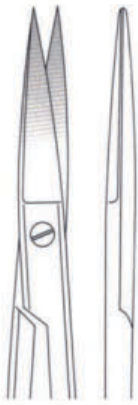

JT-22-700
 Straight



JT-22-701
 Curved

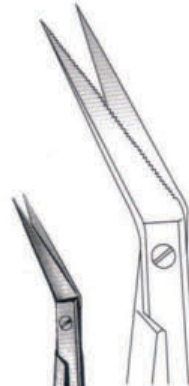
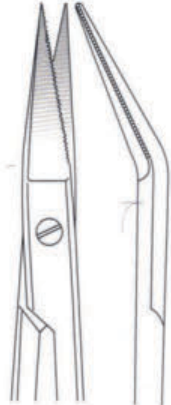

Kelly
 16 cm / 6 1/4"

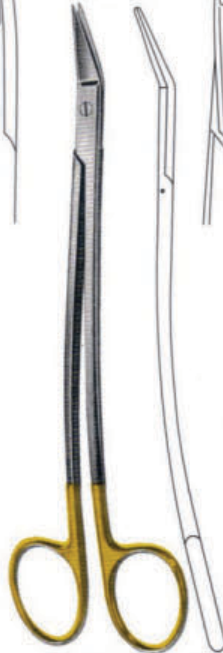

Dean
 JT-22-702
 17 cm / 6 3/4"

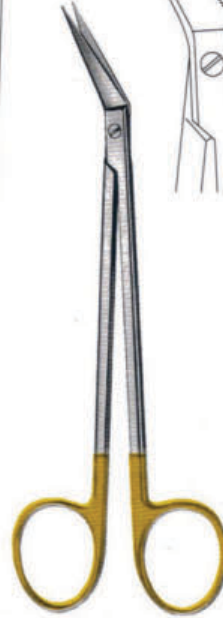

Locklin
 JT-22-703
 16 cm / 6 1/4"



Locklin
 JT-22-704
 16 cm / 6 1/4"



Mayo-Harrington
JT-22-705 Straight
JT-22-706 Curved
28 cm / 11"

Smis
JT-22-707 Straight
JT-22-708 Curved
20 cm / 8"

Parametrium
JT-22-709 Straight
JT-22-710 Curved
23 cm / 9"



English
T.O.E

J-16-001	12.5 cm / 5"
J-16-002	15 cm / 6"
J-16-003	18 cm / 7"
J-16-004	20 cm / 8"



English
B/end

J-16-005	12.5 cm / 5"
J-16-006	15 cm / 6"
J-16-007	18 cm / 7"



Treves

J-16-008	12.5 cm / 5"
J-16-009	15 cm / 6"
J-16-010	18 cm / 7"



Standard

J-16-011	10 cm / 4"	J-16-019-A
J-16-012	11.5 cm / 4½"	J-16-020
J-16-013	13 cm / 5"	J-16-021
J-16-014	14.5 cm / 5½"	J-16-022
J-16-015	16 cm / 6¼"	J-16-023
J-16-016	18 cm / 7"	J-16-024
J-16-017	20 cm / 8"	J-16-025
J-16-017A	23 cm / 9"	J-16-025A
J-16-018	25 cm / 10"	J-16-026
J-16-019	30 cm / 12"	J-16-027



Standard
Narrow



Tissue
1:2 Teeth

J-16-028	10 cm / 4"	J-16-037
J-16-029	11.5 cm / 4½"	J-16-038
J-16-030	13 cm / 5"	J-16-039
J-16-031	14.5 cm / 5½"	J-16-040
J-16-032	16 cm / 6¼"	J-16-041
J-16-033	18 cm / 7"	J-16-042
J-16-034	20 cm / 8"	J-16-043
J-16-034A	23 cm / 9"	J-16-043A
J-16-035	25 cm / 10"	J-16-044
J-16-036	30 cm / 12"	J-16-045



Tissue
2:3 Teeth



Tissue
3:4 Teeth

J-16-046	13 cm / 5"	J-16-049
J-16-047	14.5 cm / 5½"	J-16-050
J-16-048	16 cm / 6¼"	J-16-051



Tissue
4:5 Teeth

● Tissue forceps are also available in English pattern

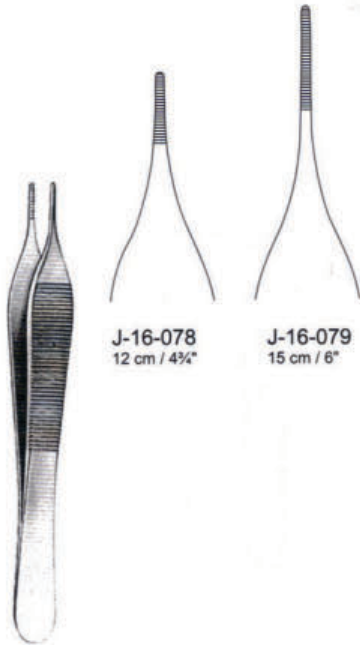

J-16-078
12 cm / 4¾"

J-16-079
15 cm / 6"

Adson

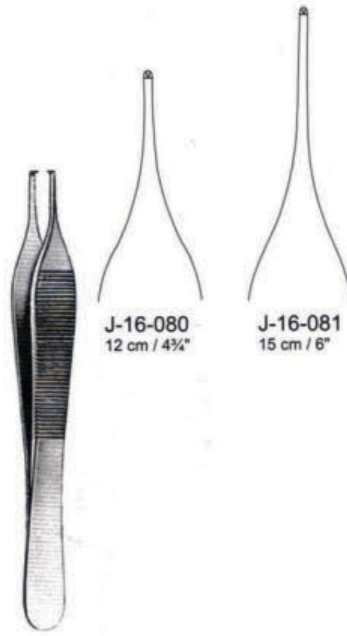

J-16-080
12 cm / 4¾"

J-16-081
15 cm / 6"

Adson
1:2 Teeth



McIndoe
J-16-082
J-16-082A 1:2 Teeth
15 cm / 6"



Gillies
J-16-083
15 cm / 6"
1:2 Teeth



J-16-184	12.5 cm / 5"	J-16-184D
J-16-184A	15 cm / 6"	J-16-184E
J-16-184B	18 cm / 7"	J-16-184F
J-16-184C	20 cm / 8"	J-16-184G
1:2 Teeth		2:3 Teeth

Lane



Waugh
J-16-085



Semken



J-16-086
12.5 cm / 5"



J-16-087
15 cm / 6"



Semken
1:2 Teeth



J-16-088
12.5 cm / 5"



J-16-089
15 cm / 6"



Potts-smith
J-16-090 18 cm / 7"
J-16-091 21 cm / 8 1/4"
J-16-092 25 cm / 10"



Potts-smith 1:2 Teeth
J-16-093 18 cm / 7"
J-16-094 21 cm / 8 1/4"
J-16-095 25 cm / 10"



Cushing
17.5 cm / 7"



J-16-096
Straight



J-16-096A
Curved



Cushing
J-16-097
J-16-097A curved
17 cm / 6 1/2"



1:2 Teeth



Taylor
J-16-098
17 cm / 6 1/2"



Taylor
J-16-099
17 cm / 6 1/2"



1:2 Teeth



Taylor
J-16-100
17 cm / 6 1/2"



Taylor
J-16-101
17 cm / 6 1/2"



1:2 Teeth

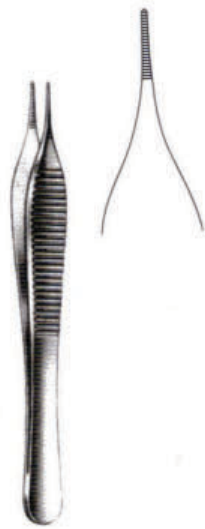

Micro-Adson
J-16-128
12 cm / 4 1/4"



Micro-Adson
J-16-129
12 cm / 4 1/4"



Adson-Brown
J-16-130
12 cm / 4 1/4"



J-16-131



J-16-132



J-16-133



J-16-134



J-16-135



J-16-136



Iris
11.5 cm / 4 1/2"



J-16-149



J-16-150

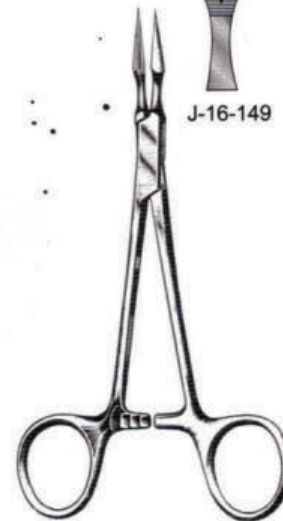

Stieglitz
13.5 cm / 5 1/4"



Normal Profile
Normal Profil
Profil Normal

Ferris Smith
JT-16-600
18 cm / 7"



0.2
JT-16-601
Micro Profile
Mikro Profil
Profil Micro

Gerald
17 cm / 6 1/2"



0.4
Mini Profile
Mini Profil
Profil Mini

Mc Indoe
JT-16-603
15 cm / 6"



0.5
JT-16-604
15 cm / 6"

Potts-Smith



0.5
JT-16-605
18 cm / 7"



0.5
JT-16-606
20 cm / 8"



0.5
JT-16-607
23 cm / 9"

Normal Profile
Normal Profil
Profil Normal



0.5
JT-16-608
25 cm / 10"



0.5
JT-16-609



0.5
JT-16-610

Normal Profile
Normal Profil
Profil Normal

Bonney
17 cm / 6 1/2"



0.4
Mini Profile
Mini Profil
Profil Mini

Gillies
JT-16-611
15 cm / 6"



0.5
JT-16-612
14 cm / 5 1/2"



0.5
JT-16-613
16 cm / 6 1/4"



0.5
JT-16-614
18 cm / 7"



0.5
JT-16-615
20 cm / 8"



0.5
JT-16-616
25 cm / 10"



0.5
JT-16-617
30 cm / 10"

Normal Profile
Normal Profil
Profil Normal

Oehler





Littauer
J-16-160
8.5 cm / 3½"



J-16-161
9 cm / 3½"



Douglas
J-16-162
9 cm / 3½"



Douglas
J-16-163
9 cm / 3½"



Beer
J-16-164
9 cm / 3½"



Gradle
J-16-165
9.5 cm / 3¾"



Henry
J-16-166
12 cm / 4¾"



Barraquer
J-16-167
10.5 cm / 4¼"

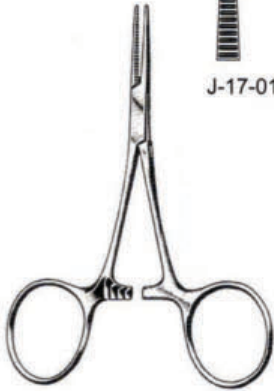

Hartmann
10 cm / 4"

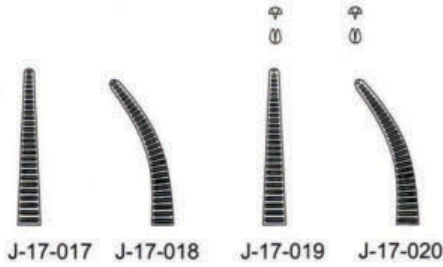

Halsted-Mosquito
12.5 cm / 5"

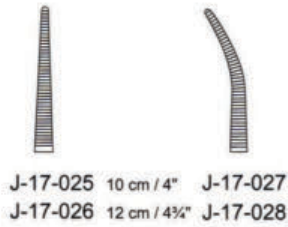
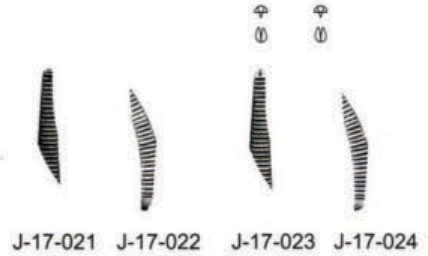

J-17-025 10 cm / 4" J-17-027
J-17-026 12 cm / 4 3/4" J-17-028



Micro-Mosquito

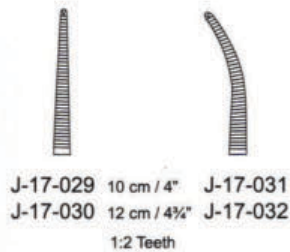

J-17-029 10 cm / 4" J-17-031
J-17-030 12 cm / 4 3/4" J-17-032
1:2 Teeth



Halsted-Mosquito

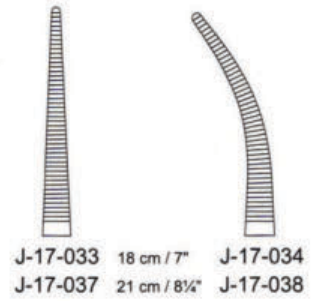

J-17-033 18 cm / 7" J-17-034
J-17-037 21 cm / 8 1/4" J-17-038

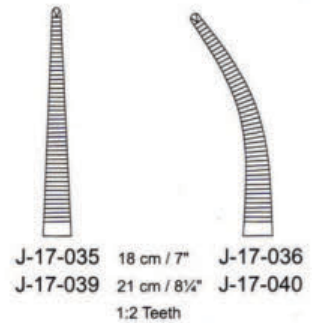

J-17-035 18 cm / 7" J-17-036
J-17-039 21 cm / 8 1/4" J-17-040
1:2 Teeth

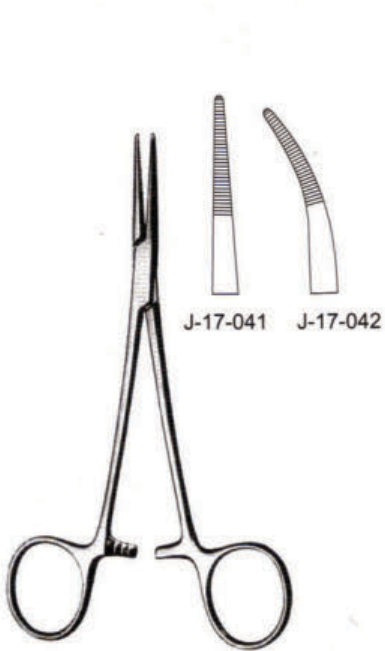

Providence-Hospital
14 cm / 5½"



Kelly
14 cm / 5½"

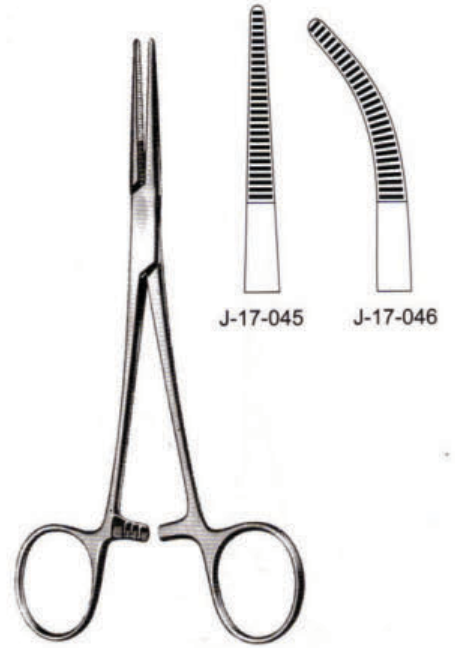

Kelly-Rankin
16 cm / 6¼"

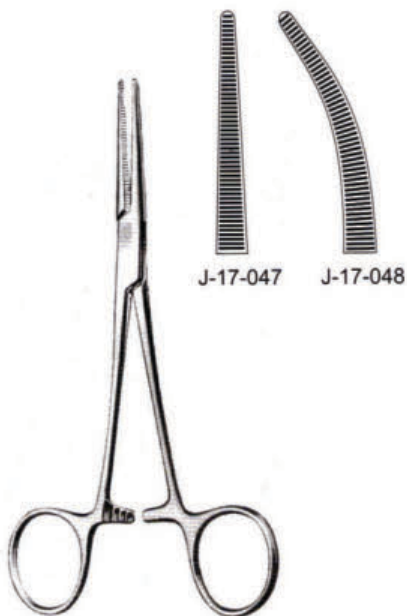

Crile
14 cm / 5½"



Crile-Rankin
16 cm / 6¼"

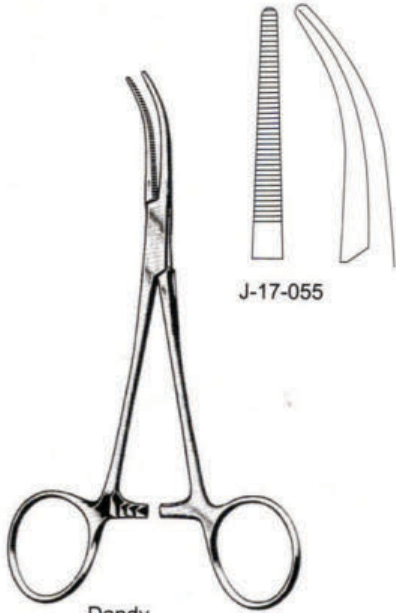

J-17-055

Dandy
14 cm / 5½"
Curved side ways

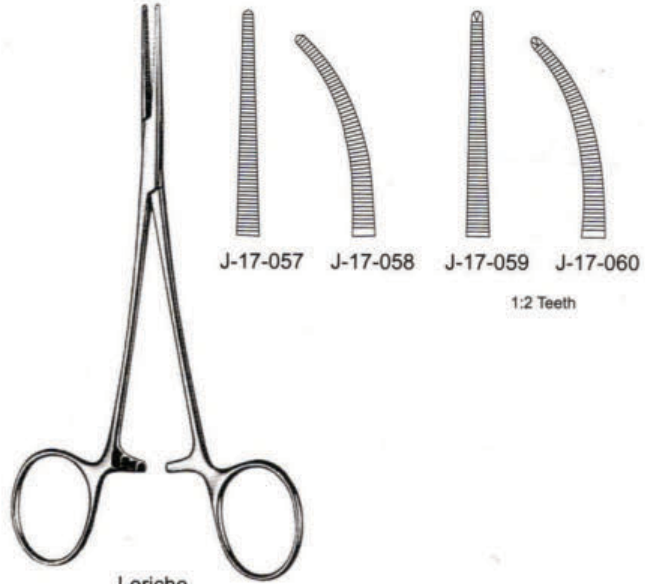

J-17-057

J-17-058

J-17-059

J-17-060

1:2 Teeth

Leriche
15 cm / 6"



J-17-079	12.5 cm / 5"	J-17-084
J-17-080	15 cm / 6"	J-17-085
J-17-081	18 cm / 7"	J-17-086
J-17-082	20 cm / 8"	J-17-087
J-17-083	23 cm / 9"	J-17-088
Straight		Curved

Spencerwells



J-17-089	12.5 cm / 5"	J-17-094
J-17-090	15 cm / 6"	J-17-095
J-17-091	18 cm / 7"	J-17-096
J-17-092	20 cm / 8"	J-17-097
J-17-093	23 cm / 9"	J-17-098
Straight		Curved

Spencerwells



Rochester-Pean

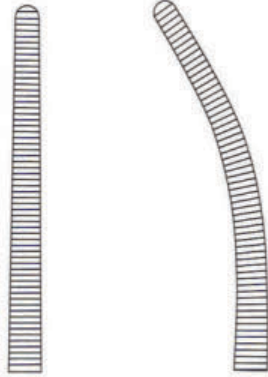

- | | | |
|----------|--------------|----------|
| J-17-101 | 14 cm / 5½" | J-17-109 |
| J-17-102 | 16 cm / 6¼" | J-17-110 |
| J-17-103 | 18 cm / 7" | J-17-111 |
| J-17-104 | 20 cm / 8" | J-17-112 |
| J-17-105 | 22 cm / 8¾" | J-17-113 |
| J-17-106 | 24 cm / 9½" | J-17-114 |
| J-17-107 | 26 cm / 10½" | J-17-115 |
| J-17-108 | 30 cm / 12" | J-17-116 |
- Straight Curved



Rochester-Ochsner

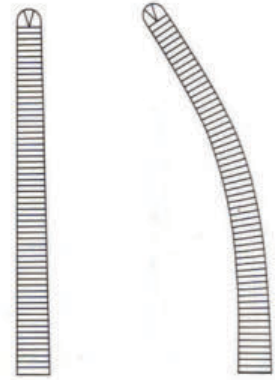

- | | | |
|----------|--------------|----------|
| J-17-117 | 14 cm / 5½" | J-17-125 |
| J-17-118 | 16 cm / 6¼" | J-17-126 |
| J-17-119 | 18 cm / 7" | J-17-127 |
| J-17-120 | 20 cm / 8" | J-17-128 |
| J-17-121 | 22 cm / 8¾" | J-17-129 |
| J-17-122 | 24 cm / 9½" | J-17-130 |
| J-17-123 | 26 cm / 10½" | J-17-131 |
| J-17-124 | 30 cm / 12" | J-17-132 |
- Straight Curved

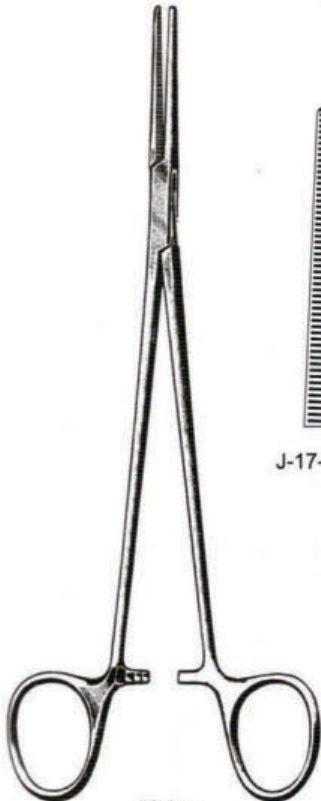

Heiss
20 cm / 8"

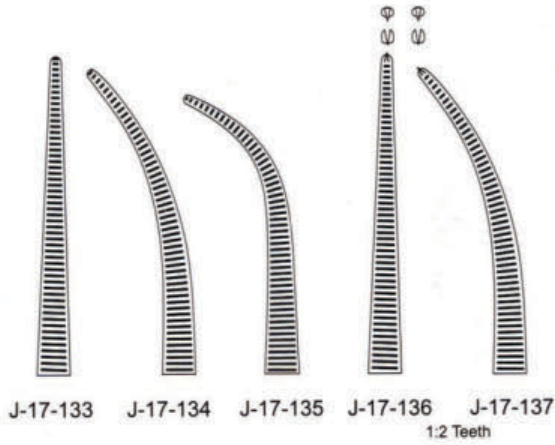

- | | | | | |
|----------|----------|----------|----------|----------|
| J-17-133 | J-17-134 | J-17-135 | J-17-136 | J-17-137 |
|----------|----------|----------|----------|----------|
- 1:2 Teeth



Adson
18 cm / 7"



- | | |
|----------|----------|
| J-17-138 | J-17-139 |
|----------|----------|

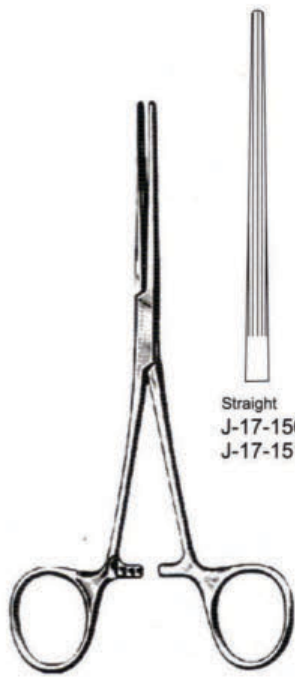

Bainbridge

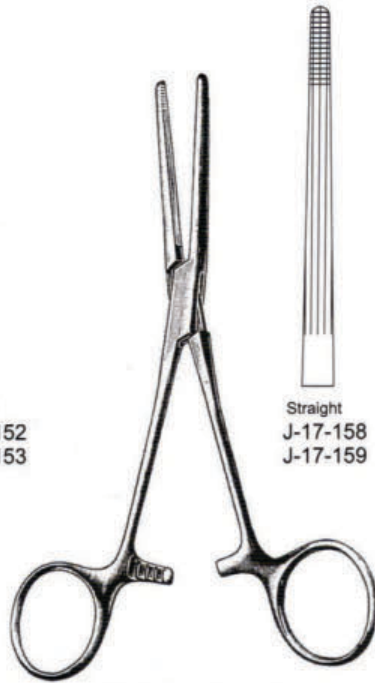
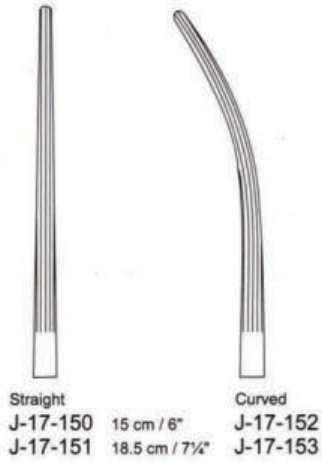

Rochester-Carmalt



Lane
J-17-171 12.5 cm / 5"
J-17-172 15 cm / 6"
J-17-173 19.5 cm / 7 1/4"

With box joint
J-17-174 12.5 cm / 5"
J-17-175 15 cm / 6"
J-17-176 19.5 cm / 7 1/4"



Fergusson

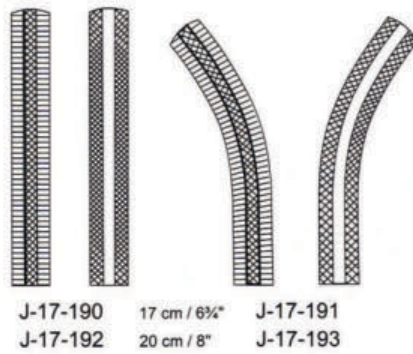

Gimini

J-17-224 13 cm / 5"
J-17-225 16 cm / 6 1/4"
J-17-226 18 cm / 7"
J-17-227 20 cm / 8"
J-17-228 23 cm / 9"
J-17-229 25 cm / 10"
J-17-230 28 cm / 11"

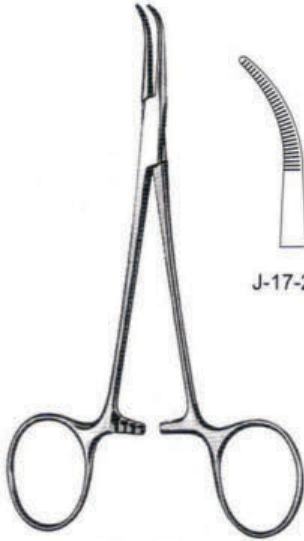

Baby-Mixer
14 cm / 5½"



J-17-243



J-17-244



Mixer-O, Shaugnessy
J-17-251
18 cm / 7"



Schmidt
19 cm / 7½"



J-17-261



J-17-262

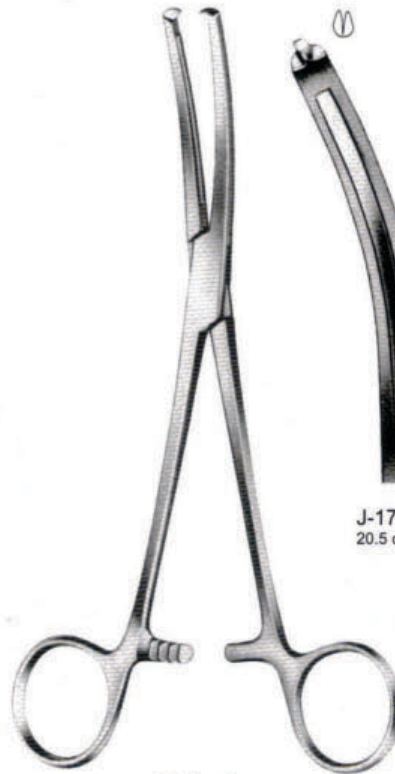

Maingot



J-17-302
20.5 cm / 8"



J-17-303
25 cm / 10"



Jones
 J-18-001 5 cm / 2"
 J-18-002 9 cm / 3½"



Schaedel
 J-18-003
 9 cm / 3½"



English Model
 J-18-004
 9 cm / 3½"



Backhaus
 J-18-008 8 cm / 3¼"
 J-18-009 11 cm / 4¼"
 J-18-010 13 cm / 5"
 J-17-011 15 cm / 6"



Roeder
 J-18-012 11 cm / 4¼"
 J-18-012A 13 cm / 5"
 J-18-013 15 cm / 6"

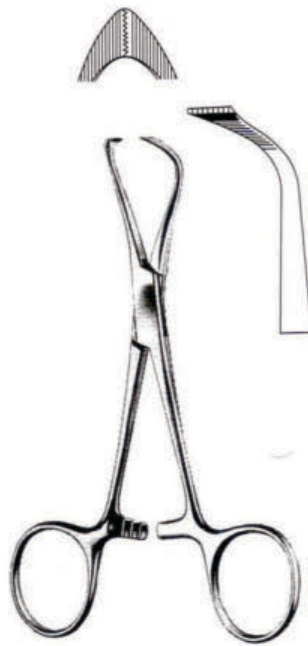

Lorna
 J-18-014 10 cm / 4"
 J-18-015 13 cm / 5¼"



Ball-Socket
 For Paper Cloths
 J-18-016 11 cm / 4¼"
 J-18-016-A 14 cm / 5½"

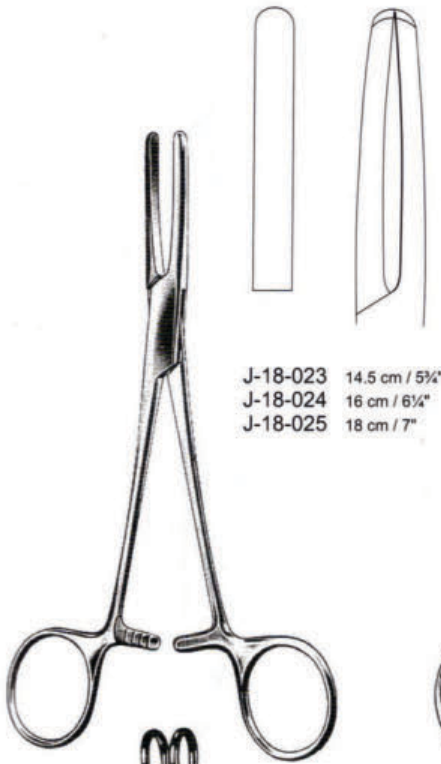

J-18-023 14.5 cm / 5½"
 J-18-024 16 cm / 6¼"
 J-18-025 18 cm / 7"

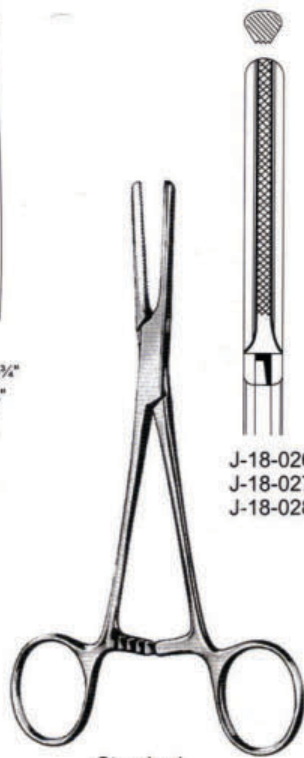

J-18-026 15 cm / 6"
 J-18-027 18 cm / 7"
 J-18-028 20 cm / 8"

Standard



J-18-045 20 cm / 8" J-18-047
 J-18-046 25 cm / 10" J-18-048

Gross-Maier



Foerster



J-20-761
 25 cm / 10"



J-20-762 18 cm / 7"
 J-20-763 20 cm / 8"
 J-20-764 25 cm / 10"

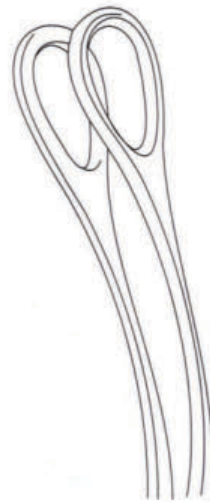

J-20-765
 25 cm / 10"

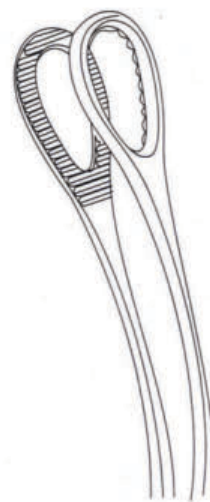

J-20-766 18 cm / 7"
 J-20-767 20 cm / 8"
 J-20-768 25 cm / 10"

Fig. 1 30 x 10 mm
Fig. 1 30 x 13 mm



Farabeuf set
J-19-001
12 cm / 4 7/8"
Fig. 2 26 x 10 mm
Fig. 2 34 x 13 mm

Fig. 1 27 x 16 mm
Fig. 1 26 x 16 mm



Farabeuf set
J-19-002
15 cm / 6"
Fig. 2 23 x 16 mm
Fig. 2 30 x 16 mm

Fig. 1 21 x 14 mm
Fig. 1 17 x 14 mm



Collin
J-19-008
15 cm / 6"
Fig. 2 28 x 16 mm
Fig. 2 32 x 16 mm

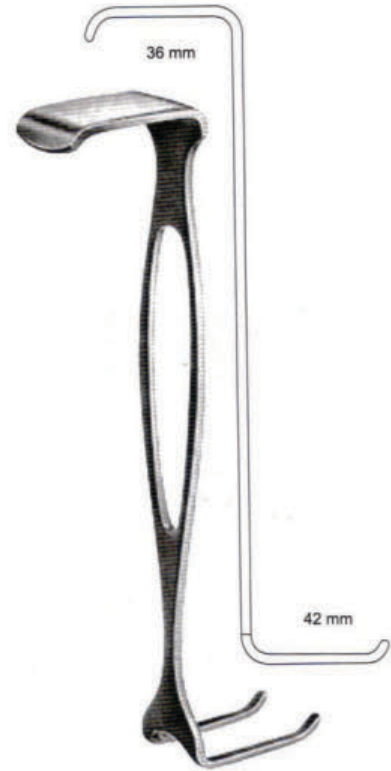

Czerny
J-19-029
17.5 cm / 7"

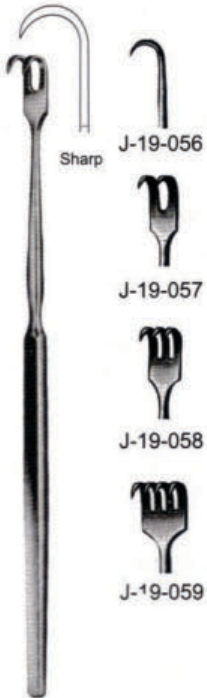

16 cm / 6 1/4"

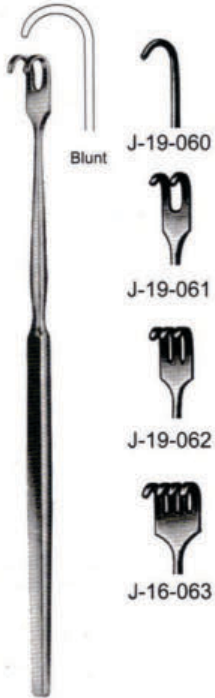

16 cm / 6 1/4"



16 cm / 6 1/4"

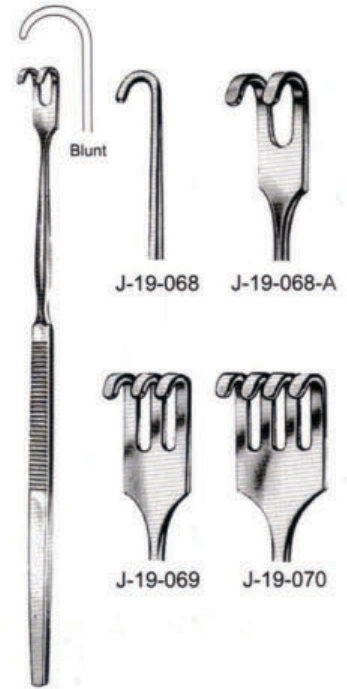

16 cm / 6 1/4"

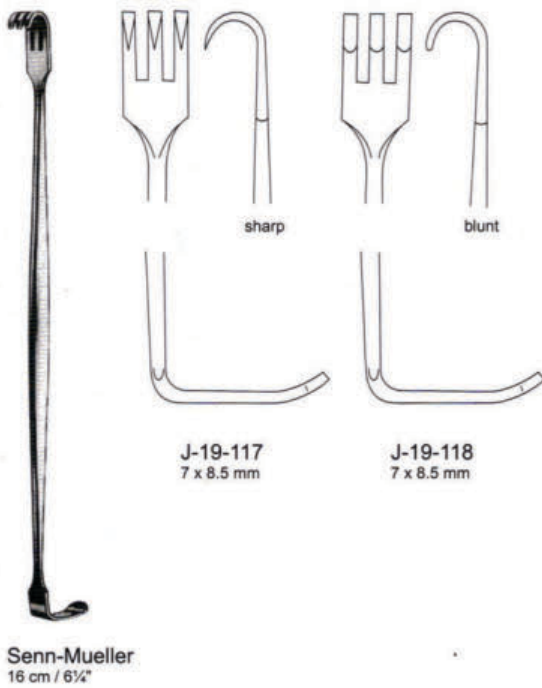
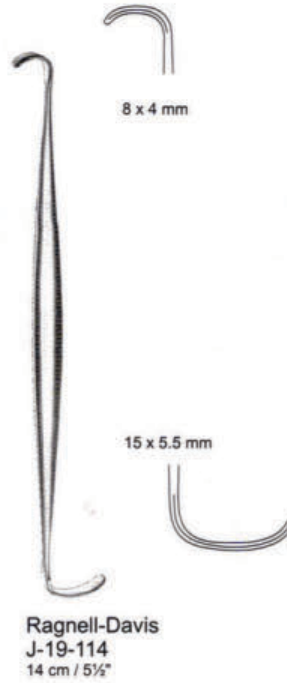
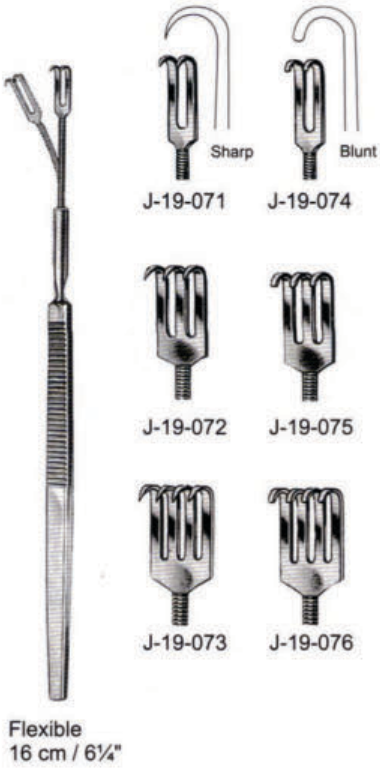



Sharp



J-19-125



J-19-126



J-19-127



J-19-128



J-19-129



Blunt



J-19-130



J-19-131



J-19-132



J-19-133



J-19-134

Volkmann
21.5 cm / 8½"



Sharp



J-19-135



J-19-136



J-19-137



J-19-138



J-19-139



Blunt



J-19-140



J-19-141



J-19-142



J-19-143



J-19-144

Volkmann
23 cm / 9"



J-19-144A

J-19-144B

J-19-144C



J-19-144D

J-19-144E

J-19-144F

Murphy
19 cm / 7½"
Sharp

Murphy
19 cm / 7½"
Blunt



Sharp

J-19-145

J-19-146

J-19-147

J-19-148

J-19-149

J-19-150

Blunt

J-19-151

J-19-152

J-19-153

J-9-154

J-19-155

J-19-156

Kocher
22 cm / 8¾"



Langenbeck
21 cm / 8¼"

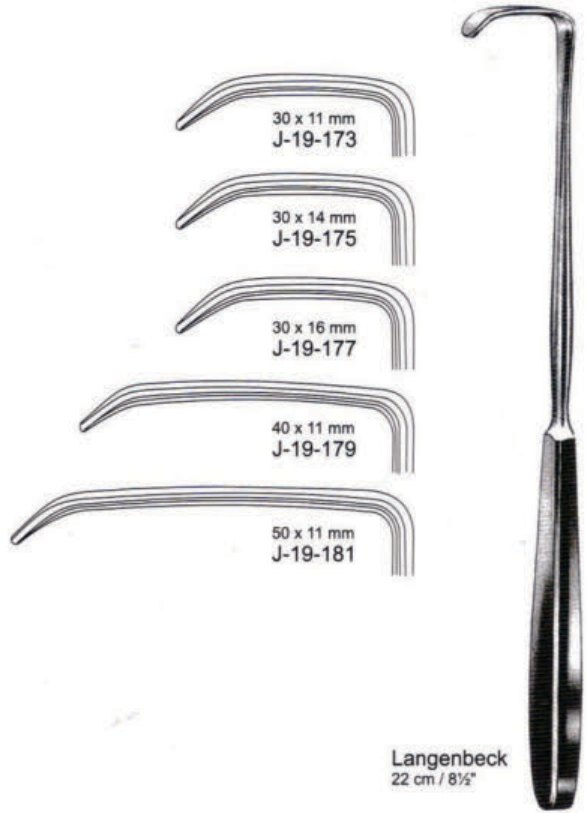
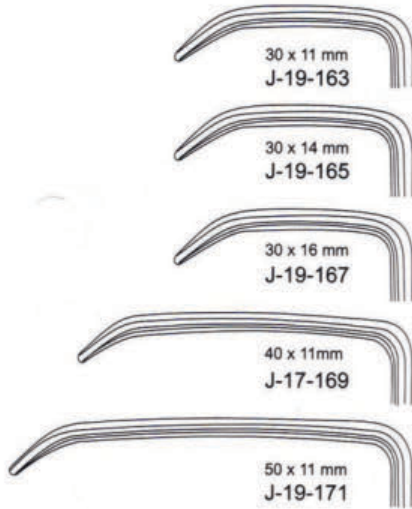

Langenbeck
22 cm / 8½"

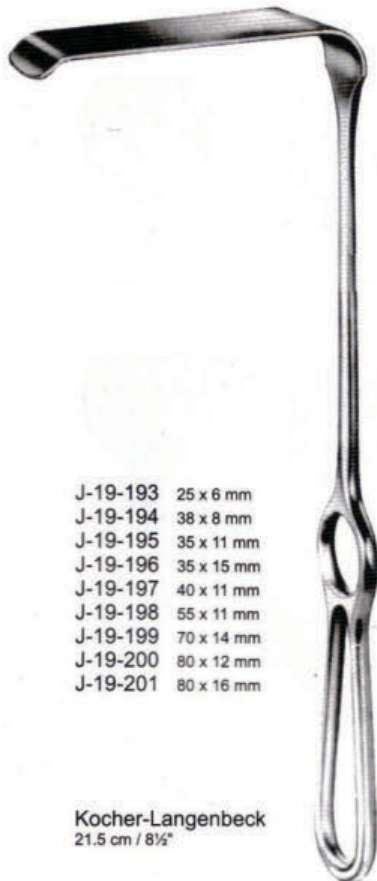
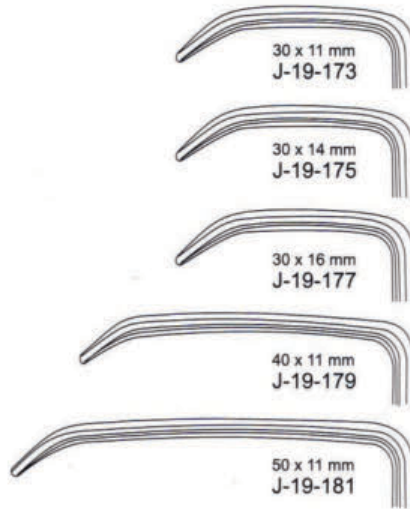

- J-19-193 25 x 6 mm
- J-19-194 38 x 8 mm
- J-19-195 35 x 11 mm
- J-19-196 35 x 15 mm
- J-19-197 40 x 11 mm
- J-19-198 55 x 11 mm
- J-19-199 70 x 14 mm
- J-19-200 80 x 12 mm
- J-19-201 80 x 16 mm

Kocher-Langenbeck
21.5 cm / 8½"



Langenbeck
J-19-184 22 x 6 mm
J-19-185 44 x 13 mm



J-19-243
52 x 16 mm
21 cm / 8¼"

J-19-244
76 x 25 mm
23 cm / 9"

Meyerding
J-19-245
89 x 50 mm
25.5 cm / 10"



ALM
 J-19-253 7 cm / 2¾" J-19-255
 J-19-254 10 cm / 4" J-19-256
 Sharp Blunt



Jansen
 10 cm / 4"



J-19-264
 Sharp



J-19-265
 Blunt



Weitlaner
 10.5 cm / 4¼"
 2:3 teeth

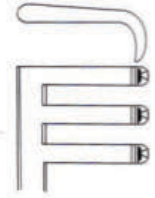

J-19-266
 sharp

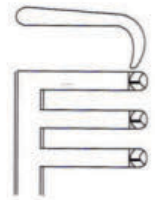

J-19-267
 blunt

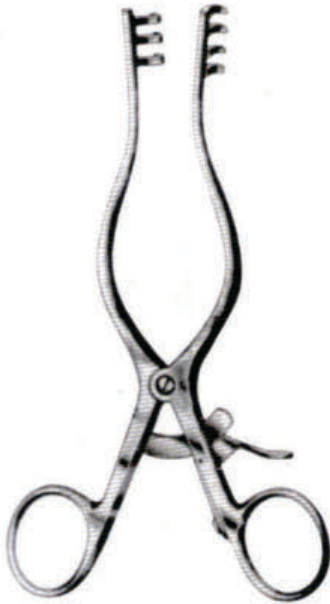

Weitlaner
 J-19-268 14 cm / 5½"
 J-19-270 16.5 cm / 6½"
 J-19-271 18 cm / 7"
 J-19-272 20 cm / 8"
 J-19-273 24.5 cm / 9½"
 Sharp
 3 x 4 Teeth



Angled
 60 mm
 50 mm
 15 x 18 mm

West
 J-19-274
 13 cm / 5¼"
 Special Mini West
 J-19-274S
 9.5 cm / 4¾"



Weitlaner-Wullstein
 14 cm / 5½"

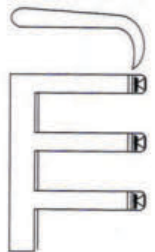

J-19-275
 Sharp

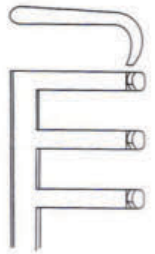

J-19-276
 blunt

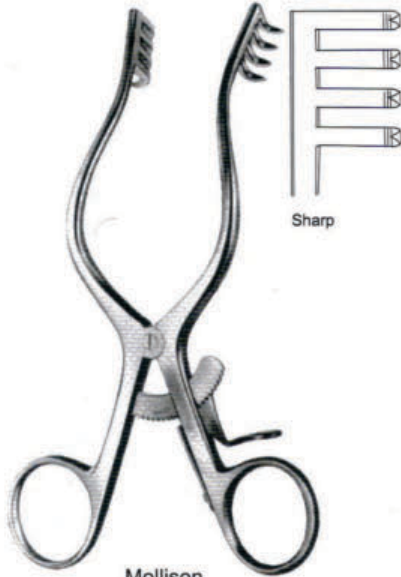

Mollison
J-19-278
15 cm / 6"



Plester
J-19-284
14 cm / 5½"
sharp / blunt
2:2 teeth



Norfolk and Norwich
J-19-285
22 cm / 8¾"
sharp / blunt



Travers
J-19-286
20 cm / 8"
Special Mini Travers
J-19-286S
9.5 cm / 4¾"



J-19-500 14 cm / 5½"
J-19-501 16 cm / 6¼"
J-19-502 20 cm / 8"
Cone Laminectomy Retractor



Gelpi
 J-19-306 9 cm / 3½"
 J-19-307 11.5 cm / 4½"
 J-19-308 14 cm / 5½"
 J-19-309 16 cm / 6¼"
 J-19-310 18 cm / 7"



Gelpi
 J-19-311 9 cm / 3½"
 J-19-312 11.5 cm / 4½"
 J-19-313 14 cm / 5½"
 J-19-314 16 cm / 6¼"
 J-19-315 18 cm / 7"
 Double Curved



Gelpi
 J-19-316
 18 cm / 7"



Stifle Retractor
 SV-2500-00



Wallace Retractor
 SV-2501-00

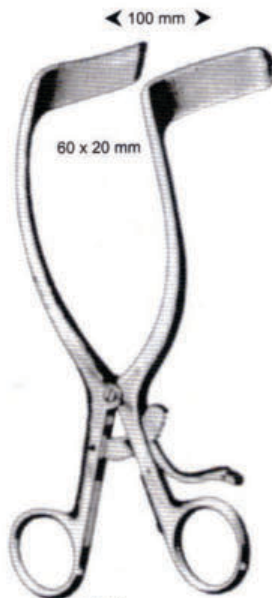

Rigby
 J-19-317
 18 cm / 7"



Mayo-Adams
 J-19-318
 17 cm / 6¾"

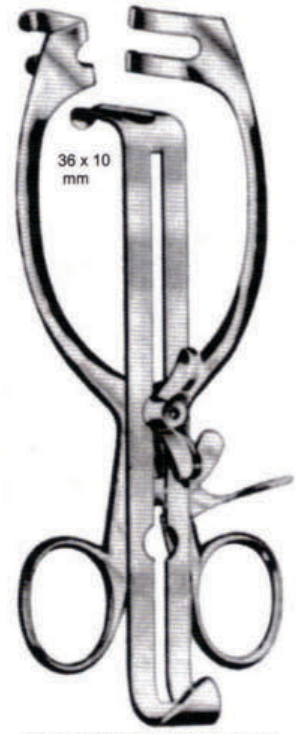

Mayo-Adams with center blade
 J-19-319
 17 cm / 6¾"

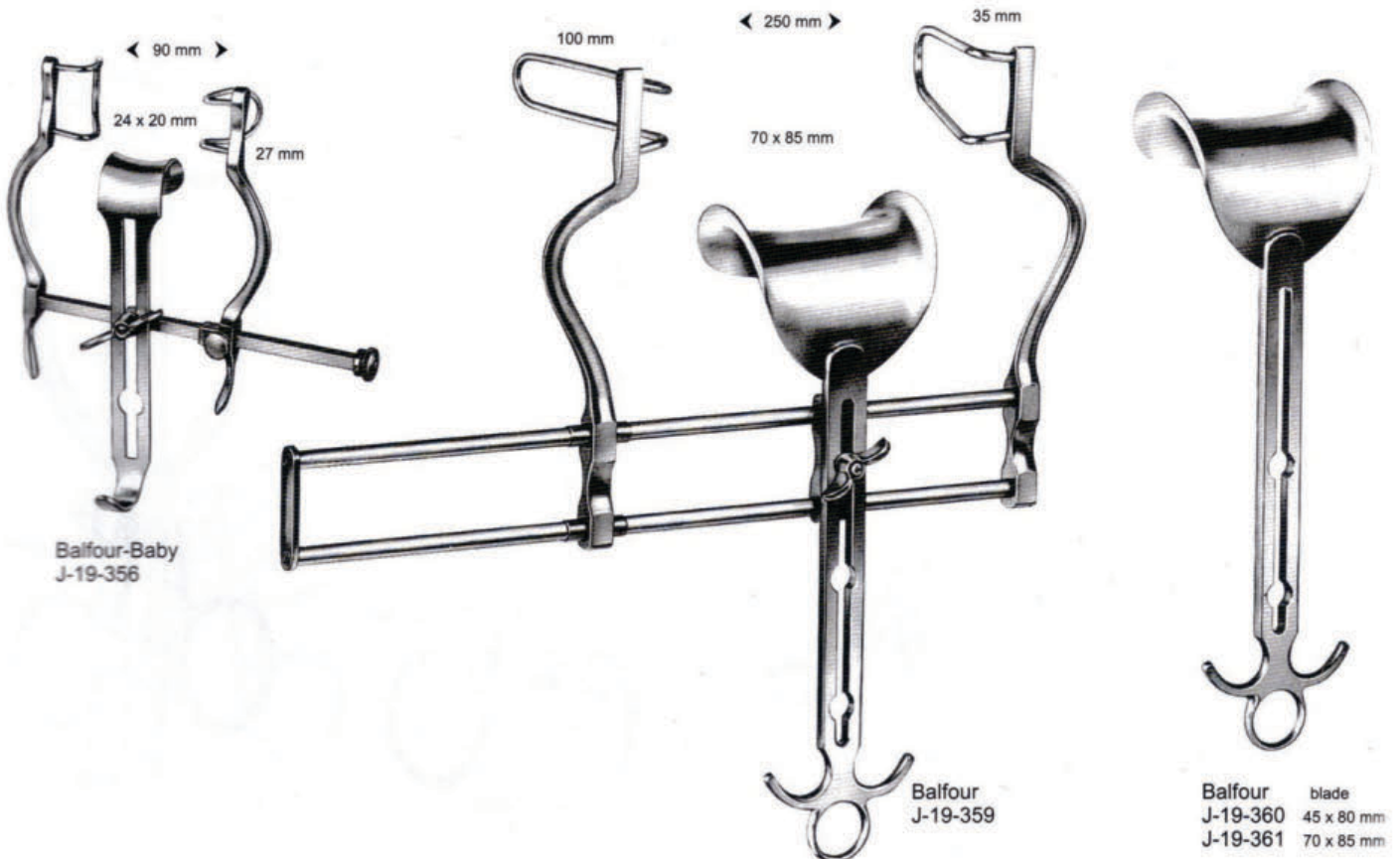

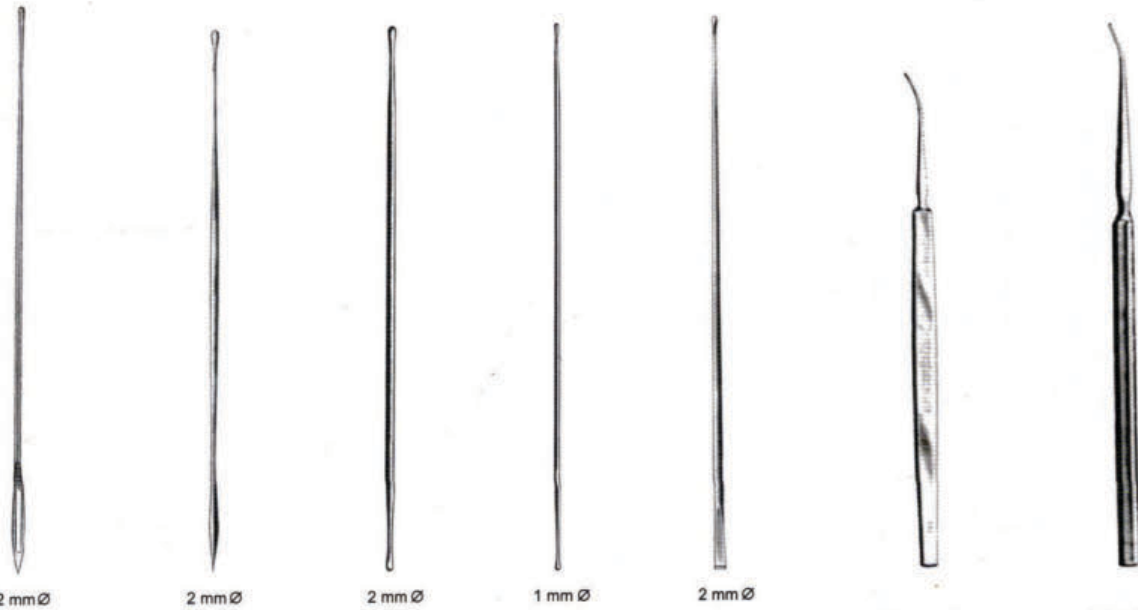

2 mm Ø	2 mm Ø	2 mm Ø	1 mm Ø	2 mm Ø	
11.5 cm / 4½"	J-23-012		J-23-028		
12.5 cm / 5"	J-23-013		J-23-029	J-23-035	
14 cm / 5½"	J-23-014	J-23-019	J-23-023	J-23-030	J-23-036
16 cm / 6¼"	J-23-015	J-23-020	J-23-024	J-23-031	J-23-037
18 cm / 7"	J-23-016	J-23-021	J-23-025	J-23-032	
20 cm / 8"	J-23-017		J-23-026	J-23-033	
25 cm / 10"	J-23-018		J-23-027	J-23-034	

Kronecker
J-23-038
13 cm / 5"

John Hopkins
J-23-039
15 cm / 6"



Butterfly
J-23-040 11.5 cm / 4½"
J-23-041 12.5 cm / 5"
J-23-042 14 cm / 5½"
J-23-043 16.5 cm / 6½"
J-23-044 18 cm / 7"
J-23-045 20.5 cm / 8"

J-23-046
J-23-047
J-23-048
J-23-049
J-23-050
J-23-051

Doyen
J-23-052
14 cm / 5½"

Nelaton
J-23-053
14 cm / 6¼"

Roser
J-23-054
12.5 cm / 5"

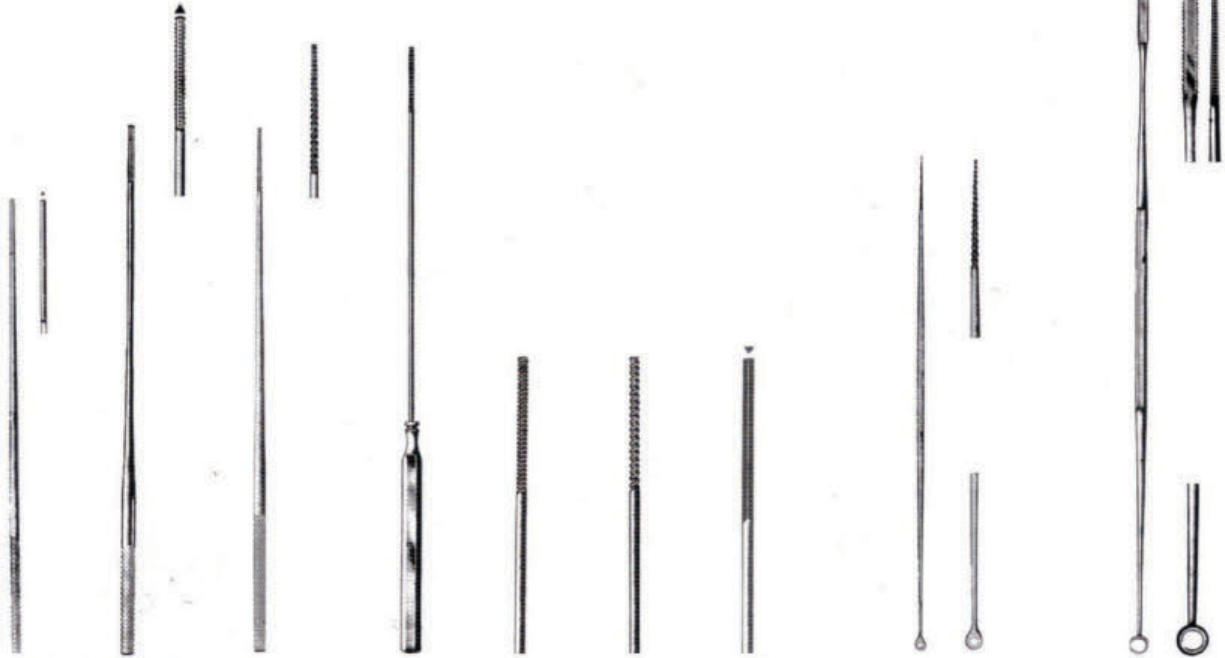

	Farrel	Farrel	Farrel			
12 cm / 4 3/4"	J-23-063	J-23-068	J-23-058			
14 cm / 5 1/2"	J-23-064	J-23-069	J-23-059	J-23-073	J-23-077	J-23-081
16 cm / 6 1/4"	J-23-065	J-23-070	J-23-060	J-23-074	J-23-078	J-23-082
18 cm / 7"	J-23-066	J-23-071	J-23-061	J-23-075	J-23-079	J-23-083
23 cm / 9"	J-23-067	J-23-072	J-23-062	J-23-076	J-23-080	J-23-084

Ukermann
J-23-057
15 cm / 6"

Jobson-Horne
J-23-055 12.5 cm / 5"
J-23-056 18 cm / 7"



J-23-085
25 cm / 10"

J-23-086
28 cm / 11"

J-23-087
28 cm / 11"

J-23-088
28 cm / 11"

Tobold
J-23-089
25 cm / 10"

Hartmann
J-23-090
20 cm / 8"

J-23-091
45 cm / 17 3/4"



Derrif
J-24-001
12 cm / 4 3/4"



Derrif
J-24-002
12.5 cm / 5"

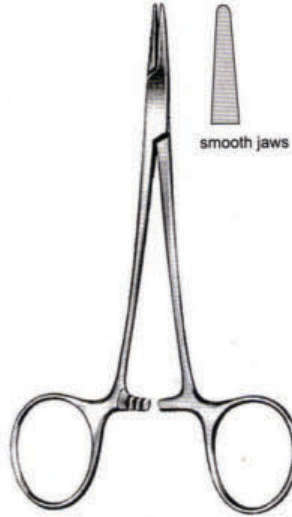

Halsey
J-24-004
12.5 cm / 5"



smooth jaws



Webster
J-24-005
13 cm / 5"



smooth Jaws



Hegar-Baumgartner
J-24-008
14 cm / 5 1/2"



Crile-Murray
J-24-010
15 cm / 6"



Crile-wood
J-24-011 15 cm / 6"
J-24-012 18 cm / 7"
J-24-013 20 cm / 8"

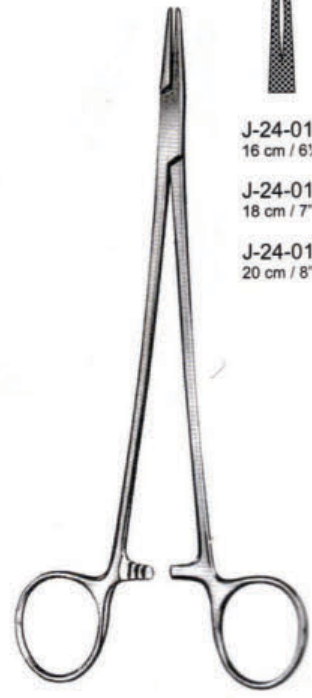

J-24-014
16 cm / 6 1/4"

J-24-015
18 cm / 7"

J-24-016
20 cm / 8"



Mayo-Hegar
Delicate pattern



Mayo-Hegar

- J-24-017
14 cm / 5½"
- J-24-018
16 cm / 6¼"
- J-24-019
18 cm / 7"
- J-24-020
20 cm / 8"
- J-24-021
24 cm / 9½"
- J-24-022
26-cm / 10¼"

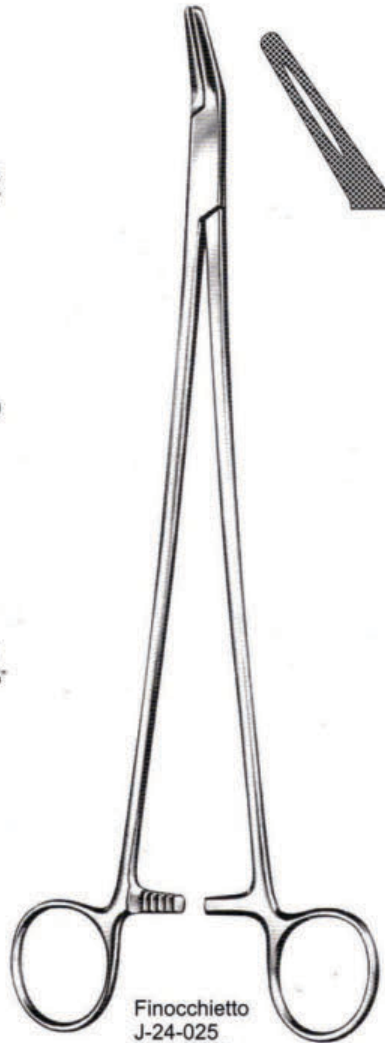

Finocchietto
J-24-025
27 cm / 10½"



Masson
J-24-028
27 cm / 10½"



Heaney
J-24-031
21 cm / 8¼"



Foerster Gillies
12.5 cm / 5"
S/J

- J-24-037
Right Hand
- J-24-038
Left Hand



Gillies
J-24-039 Right hand
J-24-040 Left hand
16 cm / 6¼"
S/J

- Mini Gillies (Special Model)
- J-24-039A Right hand
- J-24-040A Left hand
- 10 cm / 4"

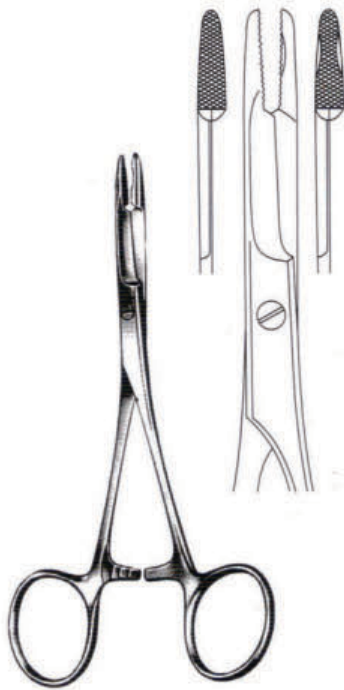

Olsen-Hegar
J-24-041
14 cm / 5½"



Olsen-Hegar
J-24-044 12 cm / 4¾" Mini
J-24-045 14 cm / 5½"
J-24-046 16 cm / 6¼"
J-24-047 18 cm / 7"



MacPhail
(cooper Jaw)
J-24-051 14 cm / 5½"
J-24-052 16- cm / 6¼"
J-24-053 18 cm / 7"
J-24-054 20 cm / 8"



Mathieu

J-24-055 14 cm / 5½" J-24-059
J-24-056 17 cm / 6¾" J-24-060
J-24-057 20 cm / 8" J-24-061
J-24-058 24 cm / 9½" J-24-062



Mathieu
Slender Jaws

J-24-063
14 cm / 5½"

J-24-064
17 cm / 6¾"



Mathieu
Heavy pattern

J-24-065
17 cm / 6¾"

J-24-066
20 cm / 8"



Ermold
SV-0594-18
18 cm / 7"



McPherson
J-24-068
10 cm / 4"



Castroviejo
without lock
13.5 cm / 5½"

J-24-069 J-24-070



Castroviejo
with Lock

J-24-071 13 cm / 5¼" J-24-072
J-24-071A 16 cm / 6¼" J-24-072A
J-24-071B 18 cm / 7" J-24-072B
J-24-071C 20 cm / 8" J-24-072C
J-24-071D 23 cm / 9" J-24-072D



Castroviejo
Extra Delicate, with lock
13.5 cm / 5½"

J-24-073 J-24-074



Barraquer
J-24-075 13 cm / 5¼" J-24-076
J-24-075A 16 cm / 6¼" J-24-076A
J-24-075B 18 cm / 7" J-24-076B
J-24-075C 20 cm / 8" J-24-076C
J-24-075D 23 cm / 9" J-24-076D
With Lock Without Lock



Barraquer
J-24-077
13 cm / 5¼"



Barraquer-Troutman
J-24-078 13 cm / 5¼"
J-24-078A 16 cm / 6¼"
J-24-078B 18 cm / 7"
J-24-078C 20 cm / 8"
J-24-078D 23 cm / 9"



Arruga
J-24-079
14 cm / 5½"



Stevens
J-24-080
16.5 cm / 6½"
with ratchet lock



Kalt
J-24-081
 13 cm / 5¼"
 Standard Model with
 delicate Jaws

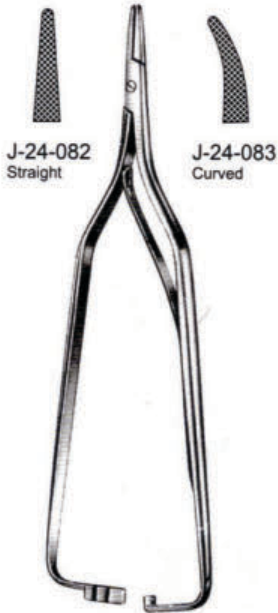

J-24-082
 Straight

J-24-083
 Curved

Arruga
 16 cm / 6¼"



Boynton
J-24-084
 12.5 cm / 5"
 Delicate



J-24-085

J-24-086

Castroviejo
 9 cm / 3½"
 with Lock / without Lock











Castroviejo
J-24-087
 12 cm / 4¾"



Castroviejo
Barraquer
J-24-088
 12 cm / 4¾"



Castroviejo
J-24-089
 13 cm / 5¼"

 <p>0.4 Mini profile Mini Profil Profil Mini</p>	 <p>Smooth Glett Lisas</p>	 <p>Smooth Glett Lisas</p>	 <p>0.5 Normal Profile Normal Profil Profil Normal</p>
<p>Derf JT-24-600 12 cm / 4 3/4"</p>	<p>Webster JT-24-601 JT-24-602 12 cm / 4 3/4"</p> <p>Smooth Serrated</p>	<p>Webster JT-24-603 JT-24-604 13 cm / 5"</p> <p>Serrated</p>	<p>Kilner JT-24-605 13.5 cm / 5 1/4"</p>
 <p>JT-24-606 Plain</p> <p>Smooth Glett Lisas</p>	 <p>0.4 JT-24-607 Serrated</p> <p>Mini Profile Mini Profil Profil Mini</p>	 <p>0.5 JT-24-608 13 cm / 5"</p> <p>0.5 JT-24-609 14 cm / 5 1/2"</p> <p>Normal Profile Normal Profil Profil Normal</p>	 <p>0.4 JT-24-610 13 cm / 5"</p> <p>0.4 JT-24-611 15 cm / 6"</p> <p>Mini Profile Mini Profil Profil Mini</p>
<p>Halsey 13 cm / 5"</p>	<p>Hegar-Baumgartner Serrated.</p>	<p>With Automatic Release Ratchet Also For Lefthander</p>	

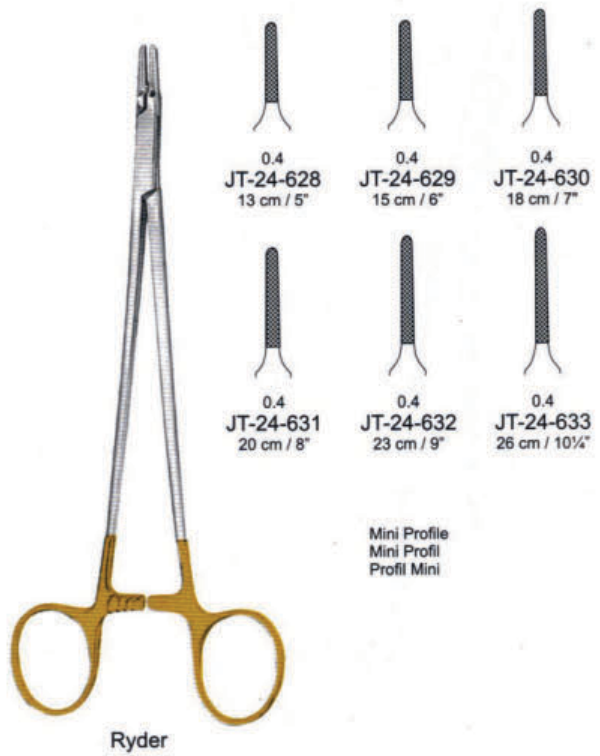
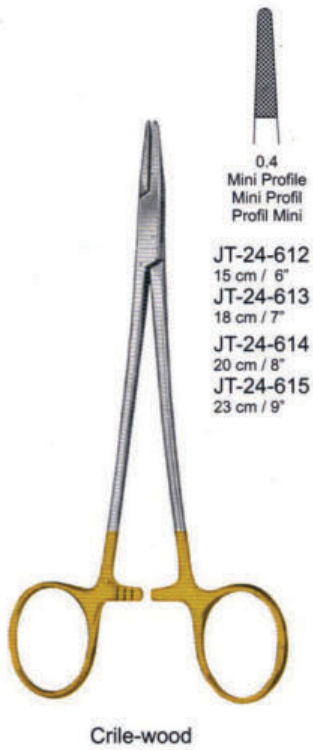



Hegar-Vascular

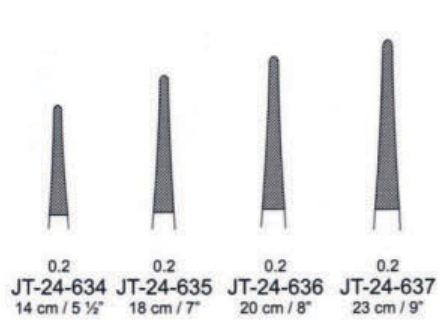

Micro Profile
Mikro Profil
Profil Micro

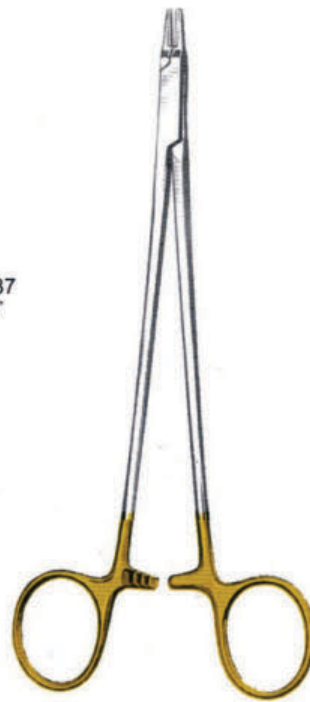

Ryder-Vascular

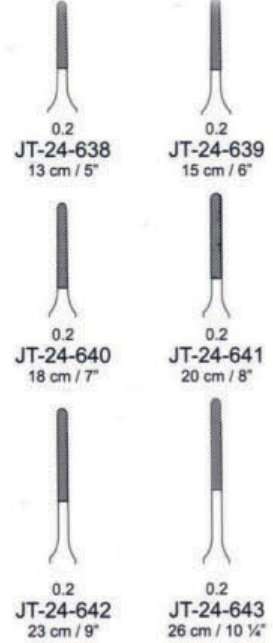

Micro Profile
Mikro Profil
Profil Micro



Stratte

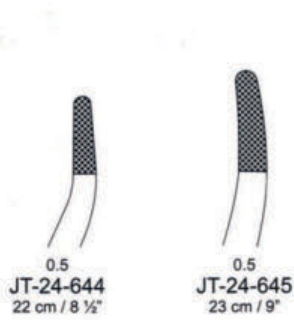

Normal Profile
Normal Profil
Profil Normal



Bozemann





0.5
JT-24-647
20 cm / 8"

0.5
JT-24-648
24 cm / 9½"

0.5
JT-24-649
26 cm / 10¼"

Normal Profile
Normal Profil
Profil Normal

Mayo-Hegar (Heaney)

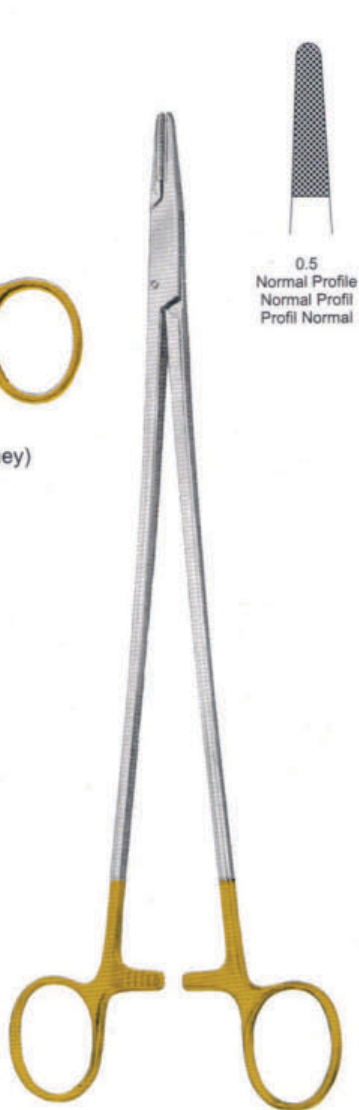

0.5
Normal Profile
Normal Profil
Profil Normal

Masson
JT-24-650
27 cm / 10 ½"



0.5
Normal Profile
Normal Profil
Profil Normal

Wangensteen
JT-24-651
27 cm / 10 ½"

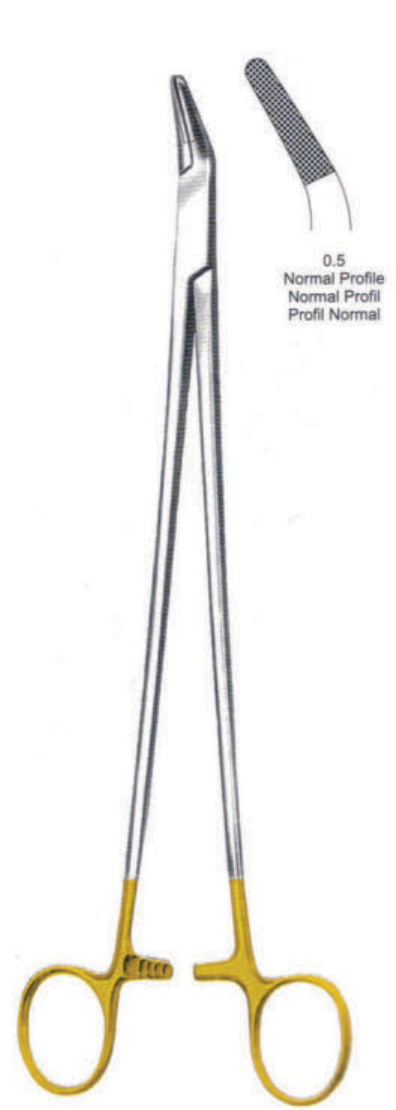

0.5
Normal Profile
Normal Profil
Profil Normal

Finocchietto
JT-24-652
27 cm / 10 ½"



0.5

JT-24-653
18 cm / 7"



0.5

JT-24-654
20 cm / 8"



0.5

JT-24-655
26 cm / 10 1/4"



0.5

Normal Profile
Normal Profil
Profil Normal



0.5

Normal Profile
Normal Profil
Profil Normal

Normal Profile
Normal Profil
Profil Normal



Sarot



Thomson Walker
JT-24-656
20 cm / 8"



Naunton Morgan
JT-24-657
26 cm / 10 1/4"



JT-24-659
14 cm / 5 1/2"



JT-24-660
16 cm / 6 1/4"



JT-24-661
17 cm / 6 1/2"

0.4
Mini Profile
Mini Profil
Profil Mini



Micro Profile
Mikro Profil
Profil Micro



Oslen-Hegar
JT-24-658
12.5 cm / 5"



Oslen-Hegar
JT-24-662
19 cm / 7 1/2"



0.4
Mini Profile
Mini profil
Profil Mini



Gillies
16 cm / 6 1/4"
JT-24-663 Right
JT-24-664 Left

Mini Gillies (Special Model)
10 cm / 4"
JT-24-665 Right
JT-24-666 Left

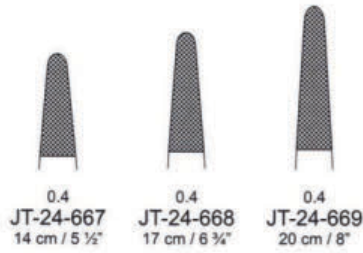

Mini Profile
Mini Profil
Profil Mini

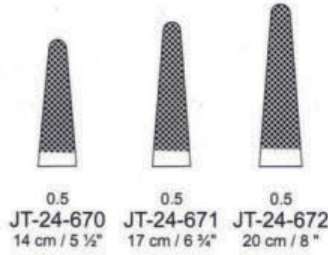

Normal Profile
Normal Profil
Profil Normal

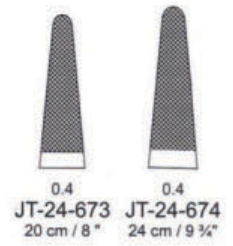

Mini Profile
Mini Profil
Profil Mini

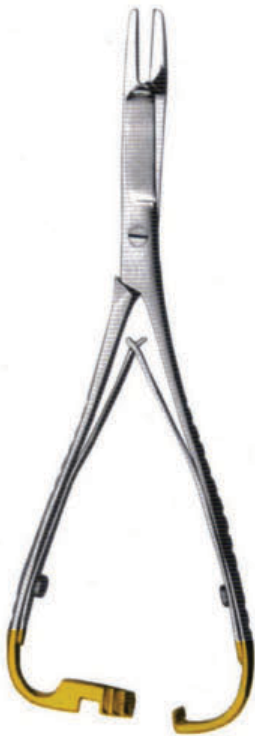

Mathieu-Olsen
JT-24-690 14 cm / 5 1/2"
JT-24-691 17 cm / 6 3/4"
JT-24-692 19 cm



Mathieu



Mathieu - Standard



Mathieu



Castroviejo

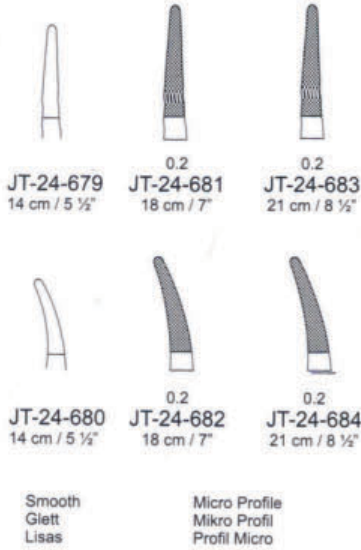

Arruga
16 cm / 6 1/4"



Castroviejo-kalt
JT-24-687
14 cm / 5 1/2"



Barraquer
JT-24-688
13 cm / 5"



Potts-Smith
JT-24-689
22 cm / 8 1/2"

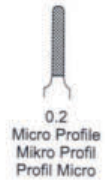



Deschamps
J-24-1019
J-24-1020
Blunt
20 cm / 8"

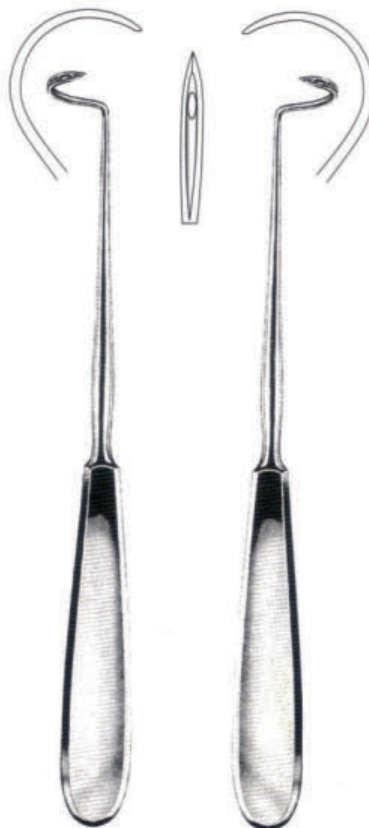

Deschamps
J-24-1021
J-24-1022
Sharp
20 cm / 8"

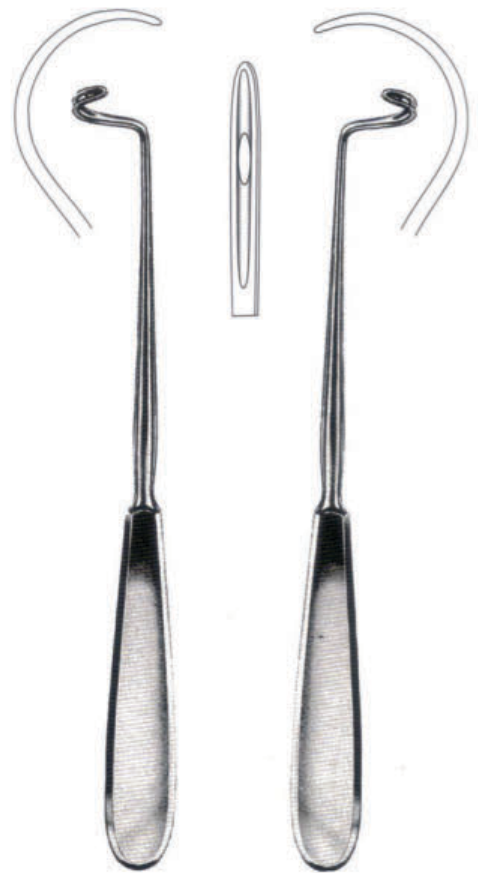

Deschamps
J-24-1023
J-24-1024
Blunt
21 cm / 8 1/4"



Deschamps
J-24-1025
J-24-1026
Sharp
21 cm / 8 1/4"

Deschamps
J-24-1027
J-24-1028
Blunt
27 cm / 10 1/2"

Deschamps
J-24-1029
J-24-1030
Sharp
27 cm / 10 1/2"

Deschamps
J-24-1031
J-24-1032
Blunt
28 cm / 11"

Curved to left
for the right
hand

Curved to right
for the left
hand



J-24-1033
15 cm / 6"



Syme
J-24-1034
17 cm / 6 3/4"



Cooper
J-24-1035
19 cm / 7 1/2"



Cooper
J-24-1036
20.5 cm / 8"



Kocher
J-24-1037
20.5 cm / 8"



Malleable
J-24-1038
23 cm / 9"

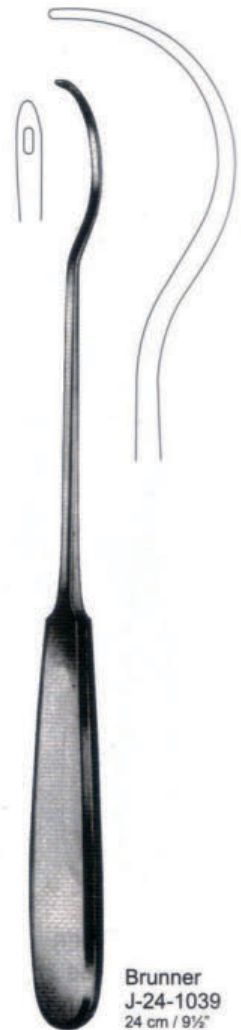

Brunner
J-24-1039
24 cm / 9 1/2"

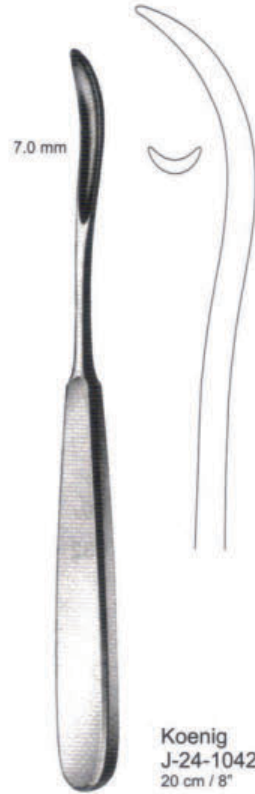



J-24-1048
28 cm / 11"



Kirschner
J-24-1049
25.5cm / 10"

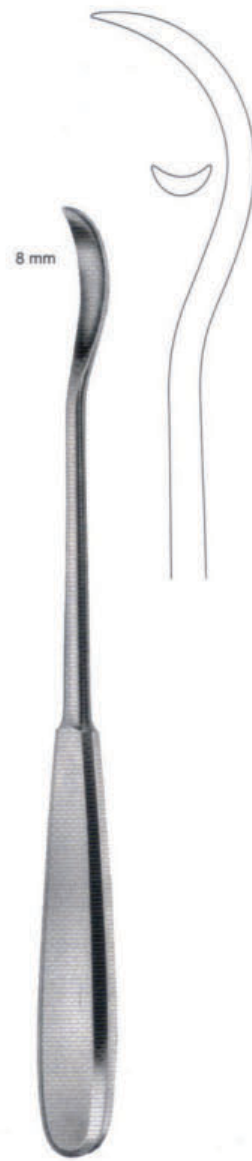

Brunner
J-24-1050
24.5 cm / 9 3/4"



J-24-1051
24 cm / 9 1/2"



Reverdin
14 cm / 5 1/2"



J-24-1000



J-24-1001



J-24-1002



J-24-1003



Reverdin



19.5 cm / 7 1/2" J-24-1005
22.5 cm / 8 1/2" J-24-1009



J-24-1006
J-24-1010



J-24-1007
J-24-1011



J-24-1008
J-24-1012



Michel
J-24-1055
12 cm / 4 3/4"



Wachenfeldt
J-24-1057
12.5 cm / 5"



Hegenbarth
J-24-1058
12.5 cm / 5"



Wachenfeldt
J-24-1059
12.5 cm / 5"

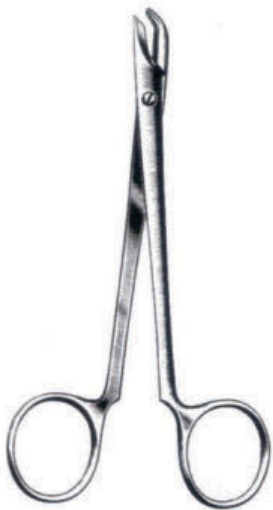

Collin
J-24-1060
13 cm / 5"



Richter-Heath
J-24-1061
14 cm / 5 1/2"



Michel
J-24-1062
12 cm / 4 3/4"



Mod. Michel
J-24-1063
12 cm / 4 3/4"



Childe
J-24-1064
18 cm / 7"



J-28-001 20 cm / 8"
J-28-010 23 cm / 9"



J-28-020
22 cm / 8½"

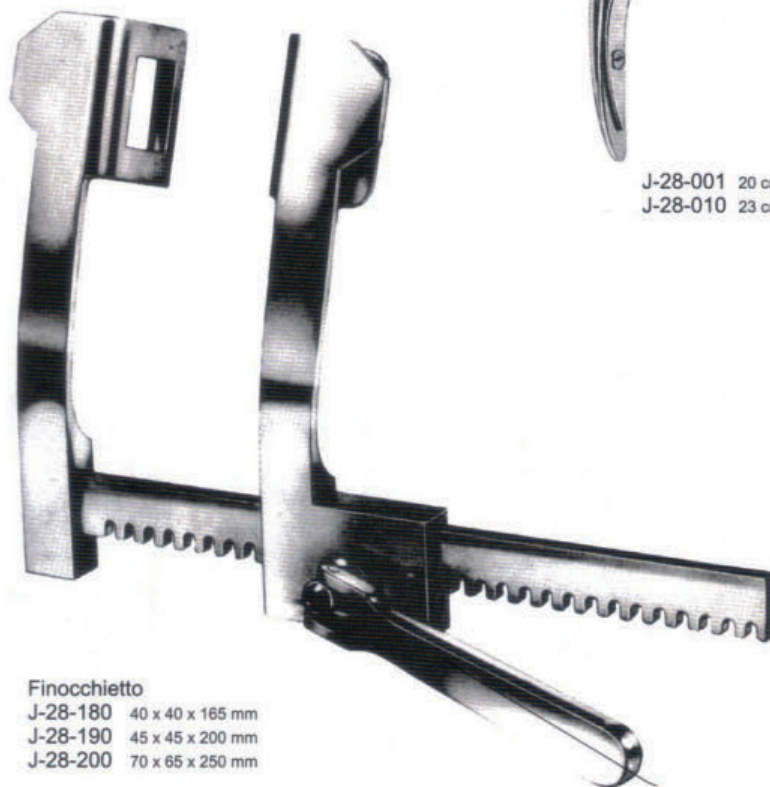

Finocchietto
J-28-180 40 x 40 x 165 mm
J-28-190 45 x 45 x 200 mm
J-28-200 70 x 65 x 250 mm

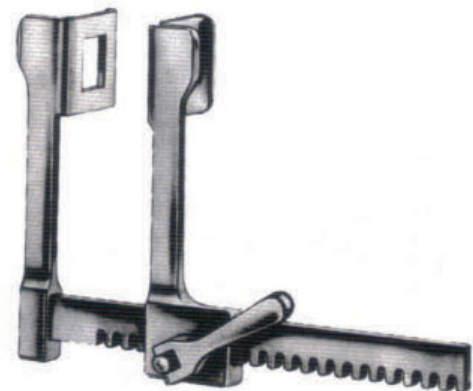

Finocchietto-Baby
J-28-170
18 x 20 x 75 mm

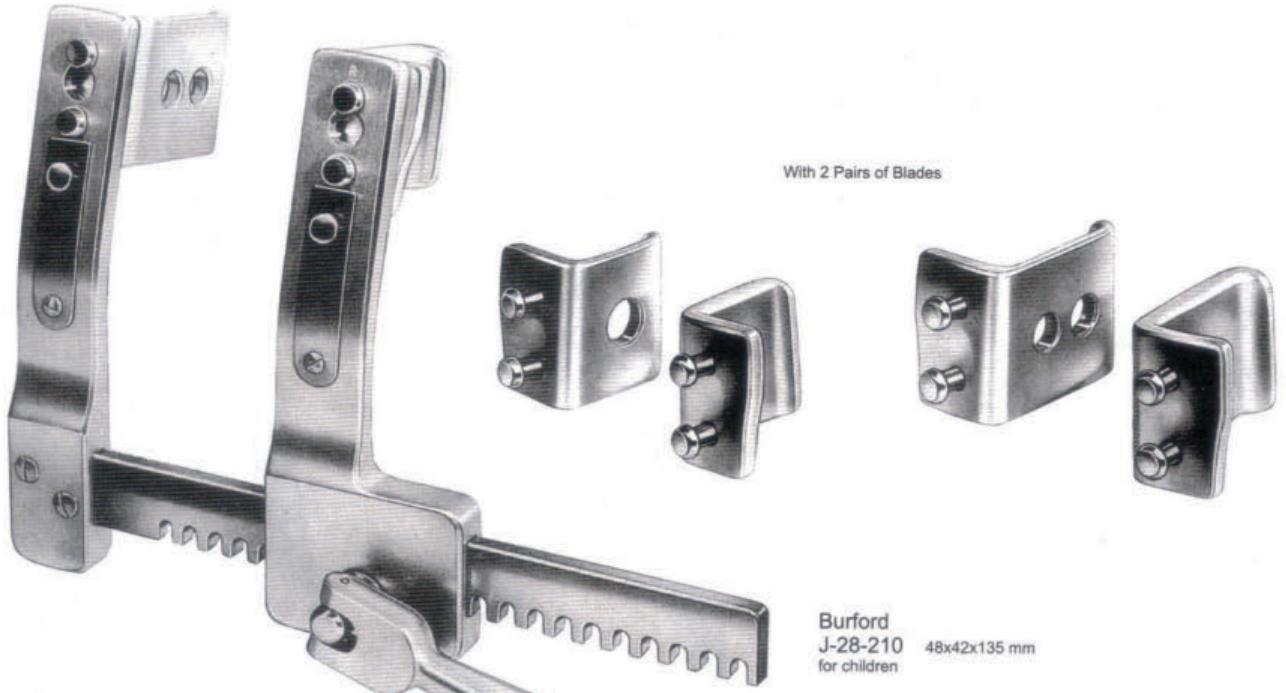



Baby-Satinsky
J-27-040
15 cm / 6"

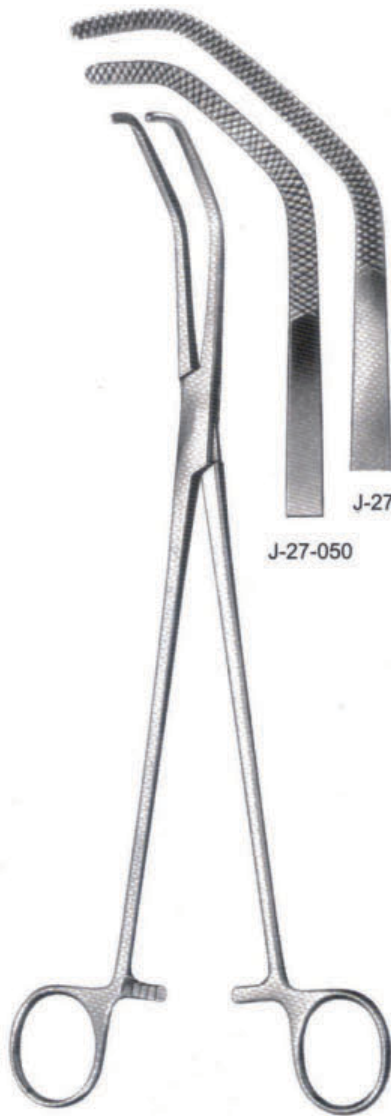

Satinsky
26.5 cm / 10½"

J-27-050

J-27-060

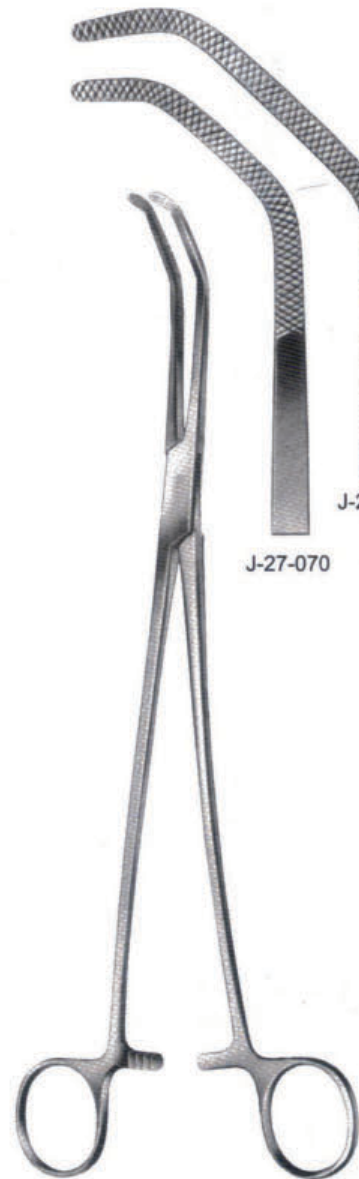

Satinsky
26.5 cm / 10½"

J-27-070

J-27-080



De Bakey

- J-27-271 16 cm / 6¼"
- J-27-271A 20 cm / 8"
- J-27-272 24 cm / 9½"
- J-27-273 30 cm / 12"



Cooley
J-27-289 16 cm / 6¼"
J-27-291 20 cm / 8"

2.0 mm



Glover

- J-27-292 6 cm / 2½"
- J-27-293 7 cm / 2¾"
- J-27-294 9 cm / 3¾"
- J-27-295 11 cm / 4½"

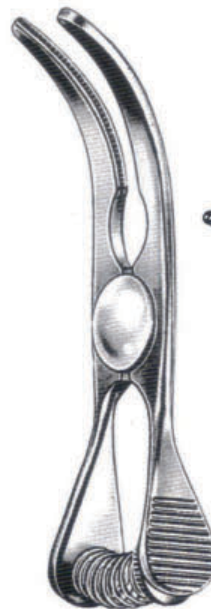

Glover

- J-27-296 5.5 cm / 2¼"
- J-27-297 6.5 cm / 2¾"
- J-27-298 8.5 cm / 3½"
- J-27-299 10.5 cm / 4½"

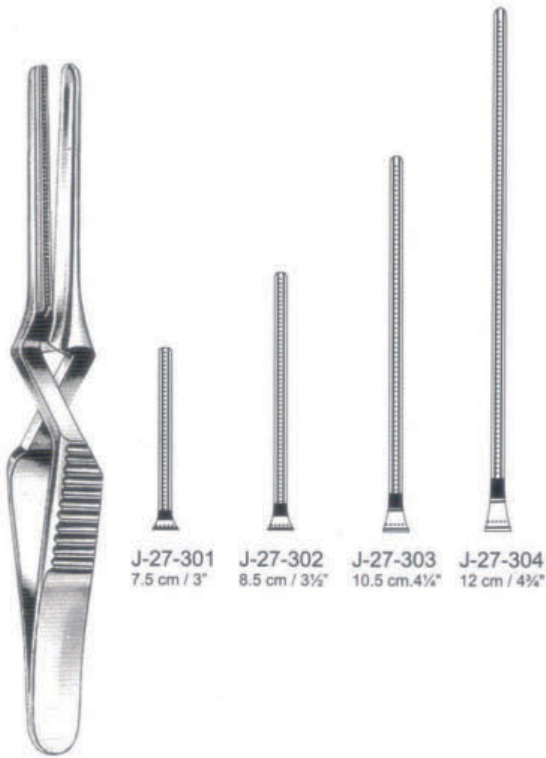

J-27-301 7.5 cm / 3"
 J-27-302 8.5 cm / 3 1/2"
 J-27-303 10.5 cm / 4 1/4"
 J-27-304 12 cm / 4 3/4"



J-27-305 7 cm / 2 3/4"
 J-27-306 8 cm / 3 1/4"
 J-27-307 10 cm / 4"
 J-27-308 11.5 cm / 4 1/2"



J-27-309 12 cm / 4 3/4"
 J-27-311 12 cm / 4 3/4"
 J-27-312 15 cm / 6"
 J-27-313 15 cm / 6"

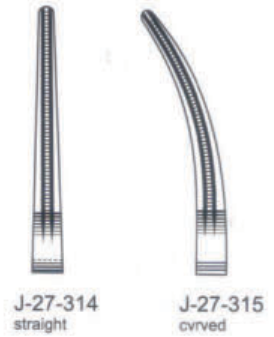

J-27-314 straight
 J-27-315 curved

Debaquey-Mosquito



Debaquey
 16 cm / 6 1/4"

Debaquey-Crile
 J-27-314
 J-27-315

Debaquey Rankin
 J-27-316
 J-27-317

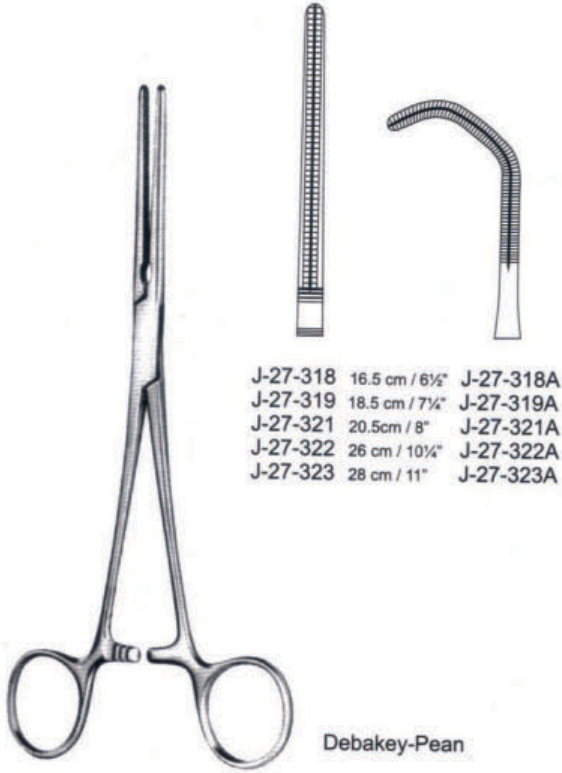

- | | | |
|----------|---------------|-----------|
| J-27-318 | 16.5 cm / 6½" | J-27-318A |
| J-27-319 | 18.5 cm / 7¼" | J-27-319A |
| J-27-321 | 20.5cm / 8" | J-27-321A |
| J-27-322 | 26 cm / 10¼" | J-27-322A |
| J-27-323 | 28 cm / 11" | J-27-323A |

Debakey-Pean

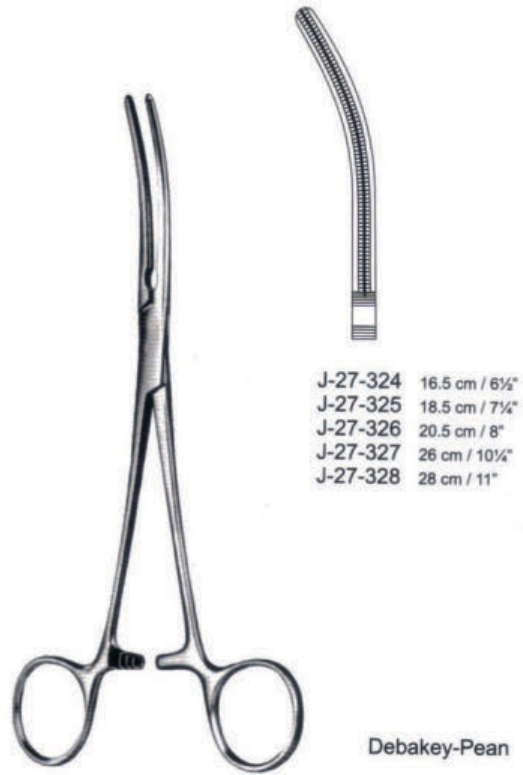

- | | |
|----------|---------------|
| J-27-324 | 16.5 cm / 6½" |
| J-27-325 | 18.5 cm / 7¼" |
| J-27-326 | 20.5 cm / 8" |
| J-27-327 | 26 cm / 10¼" |
| J-27-328 | 28 cm / 11" |

Debakey-Pean

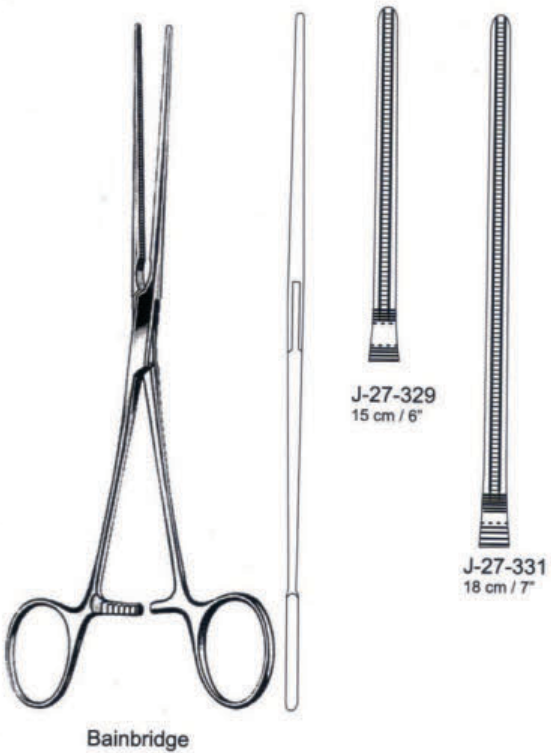

- J-27-329
15 cm / 6"

- J-27-331
18 cm / 7"

Bainbridge

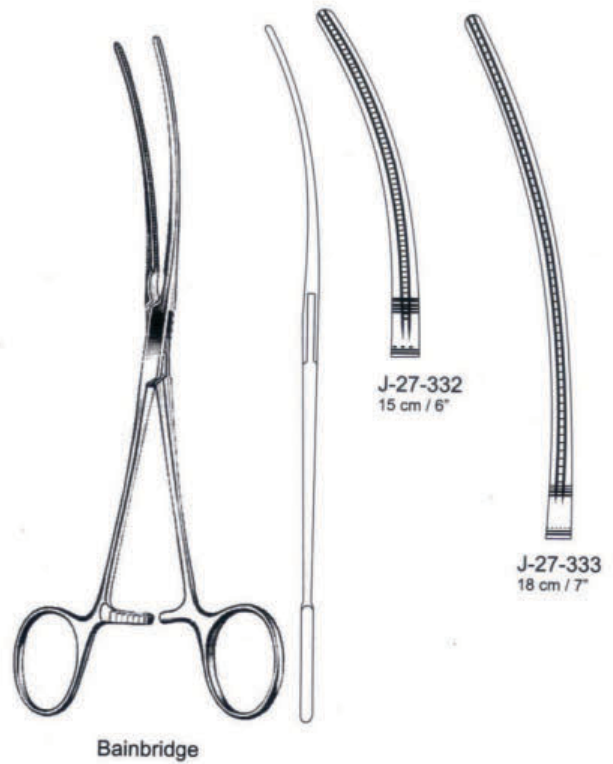

- J-27-332
15 cm / 6"

- J-27-333
18 cm / 7"

Bainbridge

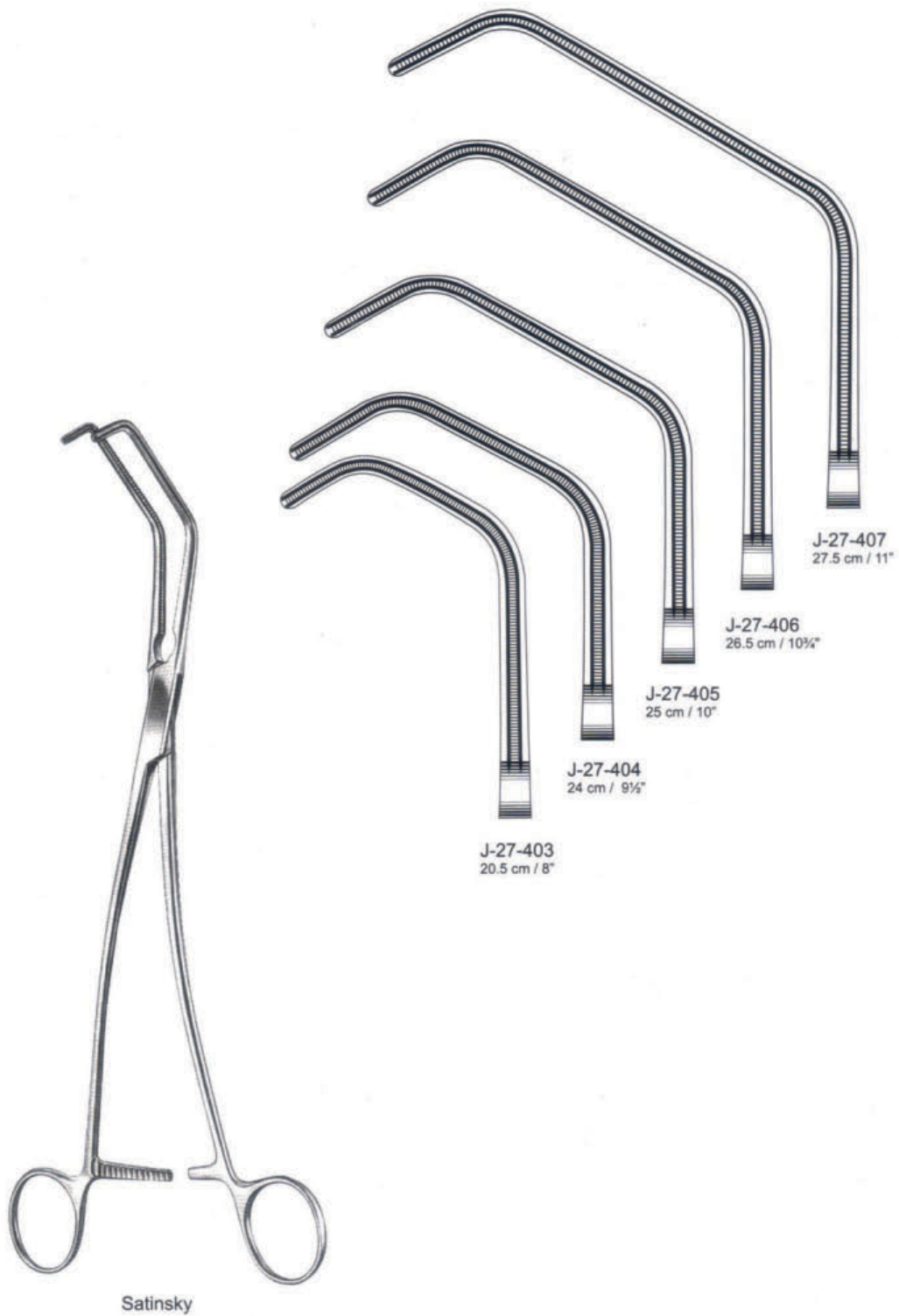



Buck
16.5 cm / 6½"



Blunt



000
J-31-670



00
J-31-680



0
J-31-690



1
J-31-700



2
J-31-710



3
J-31-720



4
J-31-730



5
J-31-740



Sharp



000
J-31-750



00
J-31-760



0
J-31-770



1
J-31-780



2
J-31-790



3
J-31-800



4
J-31-810



5
J-31-820



Buck
16.5 cm / 6½"



Blunt



000
J-31-830



00
J-31-840



0
J-31-850



1
J-31-860



2
J-31-870



3
J-31-880



4
J-31-890



5
J-31-900



Sharp



000
J-31-910



00
J-31-920



0
J-31-930



1
J-31-940



2
J-31-950



3
J-31-960



4
J-31-970



5
J-31-980



Krause
J-31-990



Krause-Voss
J-31-1000

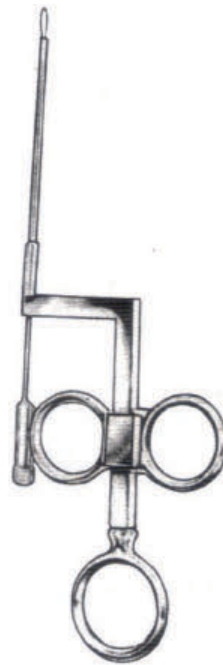

Large-Wilde
J-31-1010



10 m / 33 ft

J-31-1020 = 0.3 mm diameter
J-31-1030 = 0.4 mm diameter



J-31-1040 = 0.2 mm diameter
J-31-1050 = 0.3 mm diameter



Troeltsch
(wilde)
J-31-1060
11 cm / 4 1/2"



Troeltsch
(wilde)
J-31-1070
12 cm / 4 1/2"

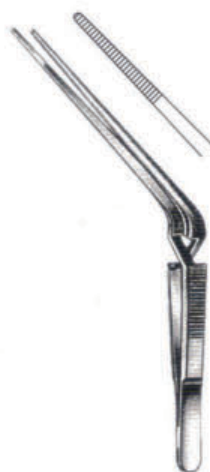

Troeltsch
(wilde)
J-31-1080
13 cm / 5"



Lucae
J-31-1090
14 cm / 5 1/2"



Jansen
J-31-1100 16 cm / 6 1/4"
J-31-1110 20 cm / 8"



Littauer
J-31-1120
12 cm / 4 3/4"



Hartmann
J-31-1130
12 cm / 4 3/4"



Hartmann
J-31-1140
14 cm / 5 1/2"



Tilley
J-31-1150
16.5 cm / 6 1/2"



Quire
J-31-1160



Buck
J-31-1170



Hartmann

J-31-1180 8.5 cm / 3 1/2"
 J-31-1190 14 cm / 5 1/2"
 J-31-1200 16.5 cm / 6 1/2"



Hartmann

J-31-1210
 8.5 cm / 3 1/2"



Hartmann Wullstein

J-31-1220
 8.5 cm / 3 1/2"



Hartmann
 1:2 Teeth

J-31-1230 8.5 cm / 3 1/2"
 J-31-1240 14 cm / 5 1/2"



Hartmann Noyes

J-31-1250
 9 cm / 3 1/2"



Hartmann Noyes

J-31-1260
 9 cm / 3 1/2"
 1:2 Teeth



Hartmann Weingartner

J-31-1270
 8.5 cm / 3 1/2"



Hartmann

J-31-1280
 8.5 cm / 3 1/2"



Hartmann
 8.5 cm / 3 1/2"

- 2 mm J-31-1290
- 2.5 mm J-31-1300
- 3 mm J-31-1310



Hartmann
 J-31-1320
 8.5 cm / 3 1/2"



Struempel
 J-31-1330
 8.5 cm / 3 1/2"



Hartmann
 J-31-1340
 8.5 cm / 3 1/2"



Hartmann



Hartmann
 J-31-1350
 8.5 cm / 3 1/2"



Hartmann Hoffmann
 J-31-1360
 8.5 cm / 3 1/2"

Tubular Shaft crocodiles are also available with an extension of "T" to the same part number

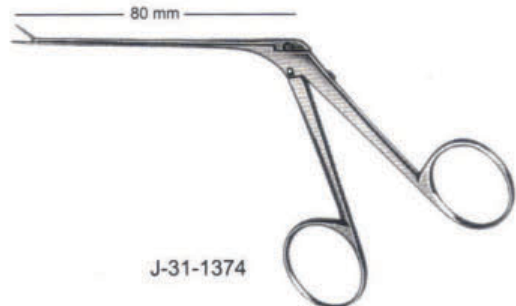
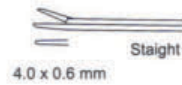
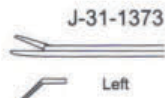
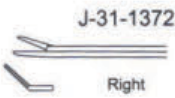
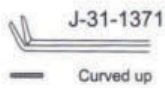
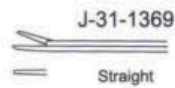
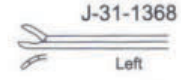
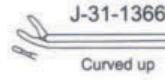
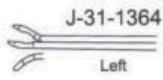
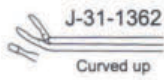
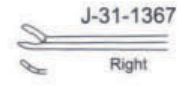
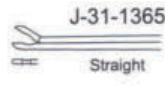
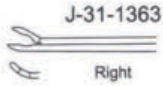
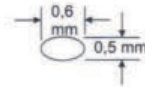
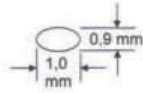

J-31-1375
Straight



J-31-1377
Right



J-31-1376
Curved up



J-31-1378
Left



Bellucci
very delicate

J-31-1379
Straight



J-31-1382
Right



J-31-1381
Curved up



J-31-1382A
Left

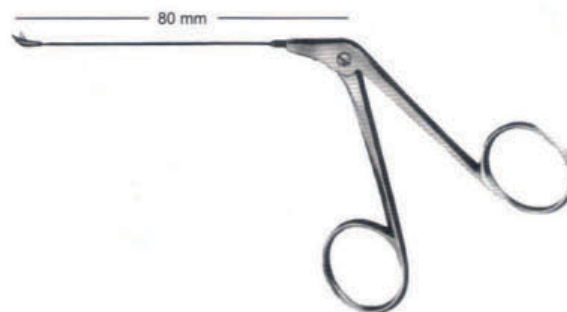

Wullstein

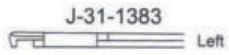

House-Dieter



Greven
J-31-1385



Citelli



Beyer
J-31-1388



Beyer
J-31-1389



McKenzie
J-25-080 15 cm / 6"
J-25-090 19 cm / 7½"



McKenzie
J-25-100 15 cm / 6"
J-25-110 19 cm / 7½"



Smithwick
J-25-120 23 cm / 9"
J-25-130 26 cm / 10 ¼"

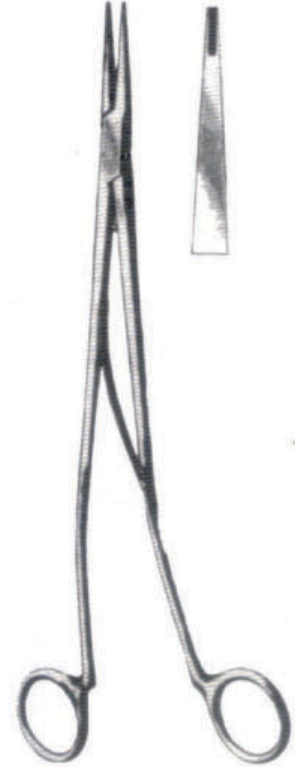

Sweet
J-25-140 23 cm / 9"
J-25-150 25 cm / 10"



Olivecrona Toennis
J-25-160
14 cm / 5½"



Raney
J-25-170
16.5 cm / 6½"



J-25-532

24 cm / 9½"



J-25-533

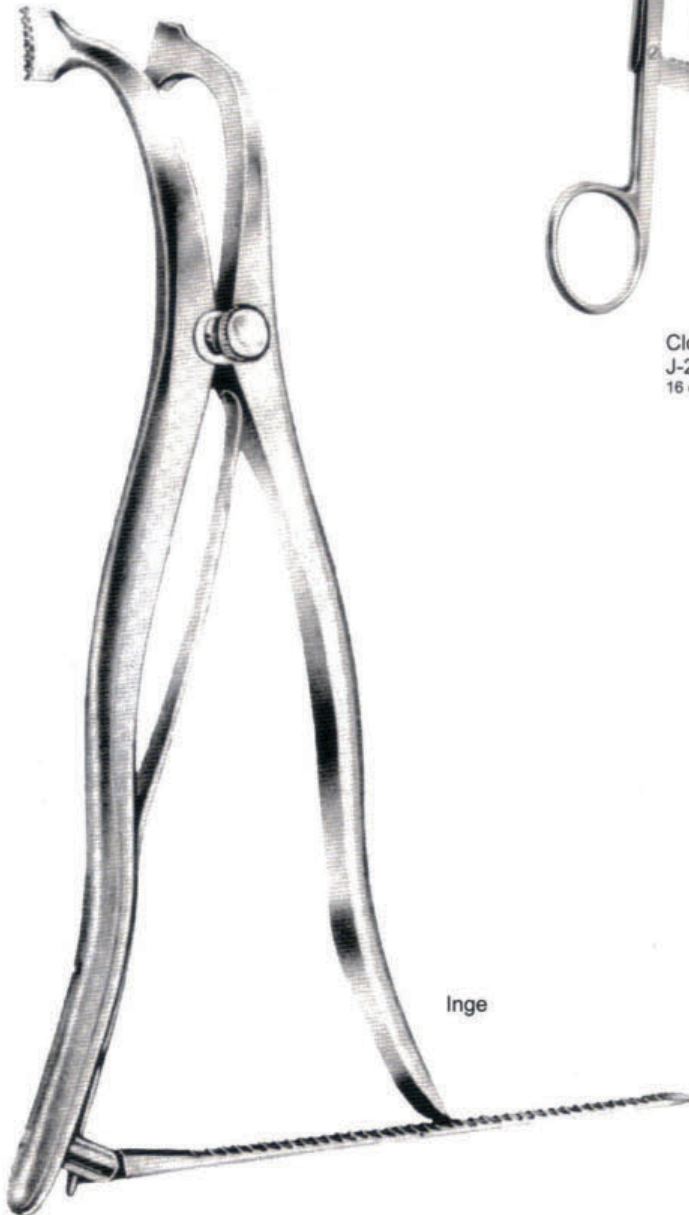

Inge



Cloward
J-25-535
16 cm / 6¼"



Cloward
J-25-534
16 cm / 6¼"
J-25-534 A
20 cm / 8"



Inge
J-25-531
16 cm / 6¼"

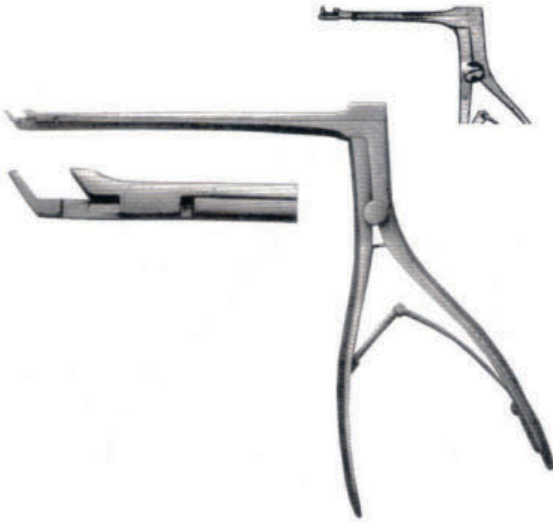

Spine Punch Forceps

- J-25-630 2mm upwards
- J-25-631 3mm upwards
- J-25-632 3mm upwards
- J-25-633 2mm 40 upwards



Ferris-Smith-Cushing

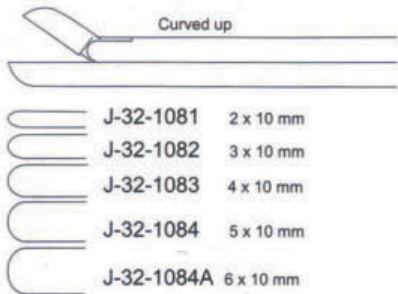

- J-32-1081 2 x 10 mm
- J-32-1082 3 x 10 mm
- J-32-1083 4 x 10 mm
- J-32-1084 5 x 10 mm
- J-32-1084A 6 x 10 mm

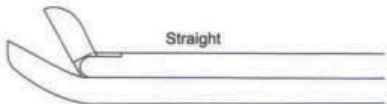

- J-32-1085 2 x 10 mm
- J-32-1086 3 x 10 mm
- J-32-1087 4 x 10 mm

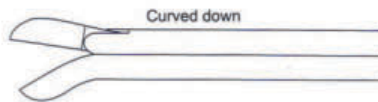

- J-32-1088 2 x 10 mm
- J-32-1089 3 x 10 mm
- J-32-1091 4 x 10 mm

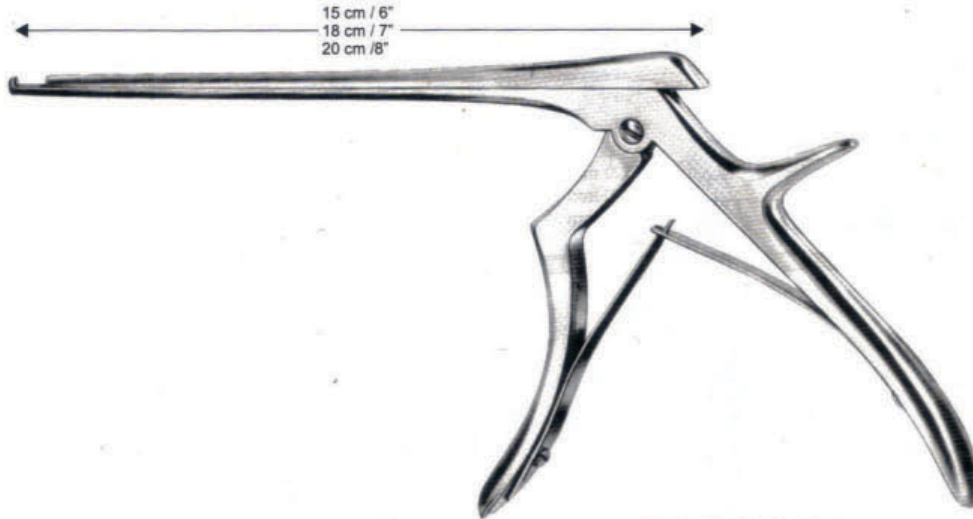

Ferris-Smith-Kerrison

Cutting Upward	
	J-25-660 15 cm
	J-25-660A 18 cm
	J-25-660B 20 cm
	1 mm
	J-25-661 15 cm
	J-25-661A 18 cm
	J-25-661B 20 cm
	2 mm
	J-25-662 15 cm
	J-25-662 18 cm
	J-25-662 20 cm
	3 mm
	J-25-663 15 cm
	J-25-663A 18 cm
	J-25-663 B 20 cm
	4 mm
	J-25-664 15 cm
	J-25-664A 18 cm
	J-25-664B 20 cm
	5 mm
	J-25-665 15 cm
	J-25-665A 18 cm
	J-25-665 B 20 cm
	6 mm

Cutting Downward	
	J-25-666 15 cm
	J-25-666A 18 cm
	J-25-666B 20 cm
	1 mm
	J-25-667 15 cm
	J-25-667A 18 cm
	J-25-667B 20 cm
	2 mm
	J-25-668 15 cm
	J-25-668A 18 cm
	J-25-668B 20 cm
	3 mm
	J-25-69 15 cm
	J-25-669A 18 cm
	J-25-669B 20 cm
	4 mm
	J-25-670 15 cm
	J-25-670A 18 cm
	J-25-670B 20 cm
	5 mm
	J-25-671 15 cm
	J-25-671A 18cm
	J-25-671B 20cm
	6 mm

Cutting Forward	
	J-25-672 15 cm
	J-25-672A 18 cm
	J-25-672B 20cm
	1 mm
	J-25-673 15 cm
	J-25-673A 18cm
	J-25-673B 20 cm
	2 mm
	J-25-674 15 cm
	J-25-674A 18 cm
	J-25-674B 20 cm
	3 mm
	J-25-675 15 cm
	J-25-675A 18 cm
	J-25-675B 20 cm
	4 mm
	J-25-676 15 cm
	J-25-676A 18 cm
	J-25-676B 20 cm
	5 mm
	J-25-677 15 cm
	J-25-677A 18 cm
	J-25-677B 20 cm
	6 mm



Babcock

- J-35-281 16 cm / 6¼"
- J-35-282 18 cm / 7"
- J-35-284 20 cm / 8"
- J-35-285 24 cm / 9½"
- J-35-286 30 cm / 12"

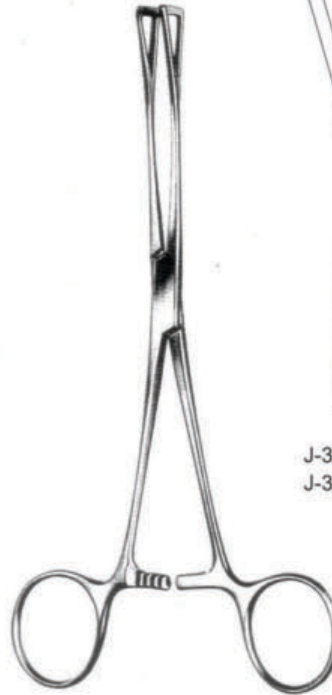

Duval



- J-35-287 18 cm / 7"
- J-35-289 20 cm / 8"

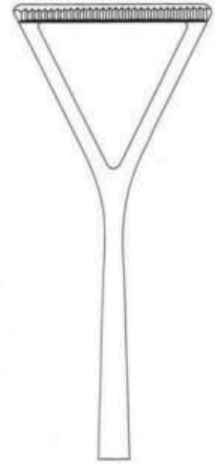

- J-35-288 20 cm / 8"
- J-35-291 23 cm / 9"



Allis-Atrauma

- J-35-294 16 cm / 6¼"
- J-35-295 20 cm / 8"
- J-35-296 25 cm / 10"
- J-35-297 30 cm / 12"

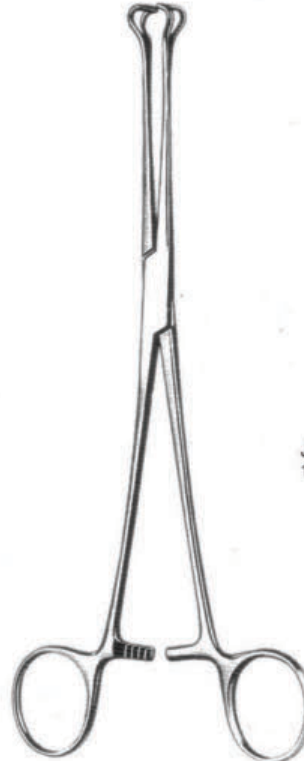

Babcock-Atrauma

- J-35-292 16 cm / 6¼"
- J-35-293 20 cm / 8"



0.5
JT-35-351
16 cm / 6 1/4"



Babcock

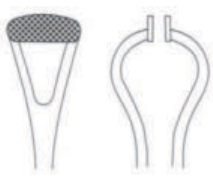

0.5
JT-35-352
20 cm / 8"
Normal Profile
Normal profil
Profil Normal

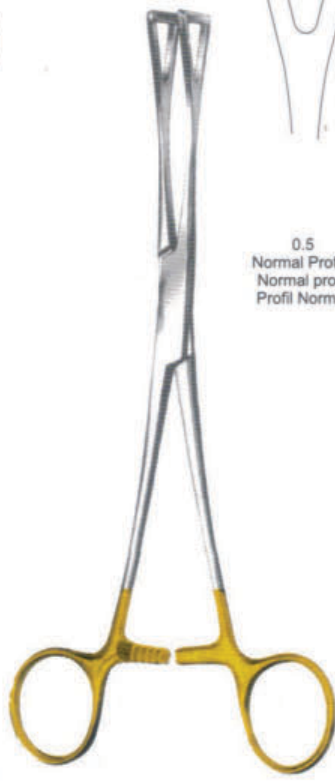

Duval
JT-35-353
20 cm / 8"



0.5
Normal Profile
Normal profil
Profil Normal



Tc-Rubin
JT-35-354
21 cm / 8 1/2"



Baby-Doyen
17 cm / 6 3/4"



J-35-355



J-35-356



Doyen



J-35-357 21 cm / 8 1/4" J-35-359
J-35-358 23 cm / 9" J-35-361

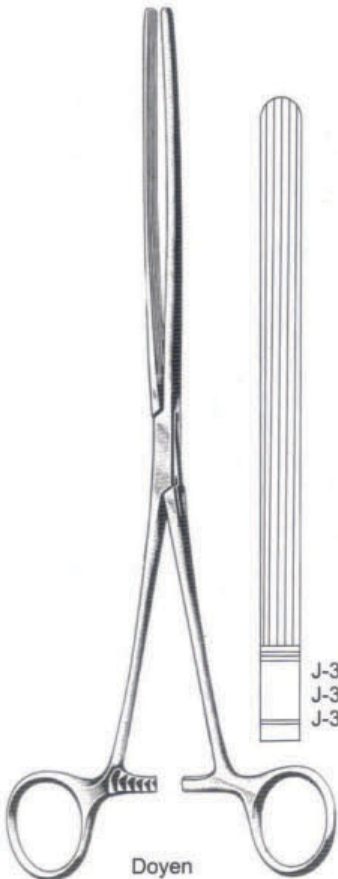

Doyen



J-35-362 17 cm / 6 1/2" J-35-365
J-35-363 21 cm / 8 1/4" J-35-365A
J-35-364 24 cm / 9 1/2" J-35-365B



Mayo Robson
25 cm / 10"

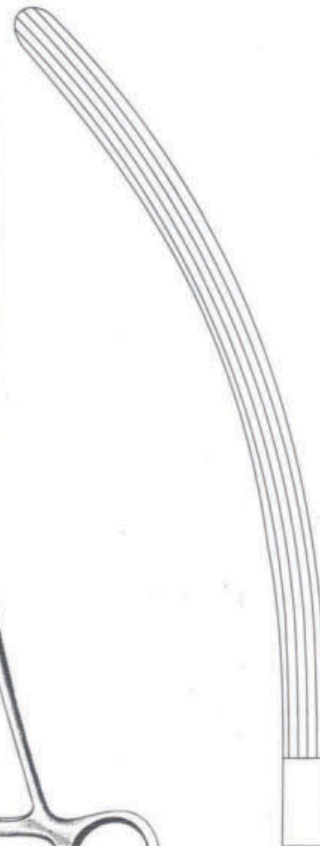

J-35-367 J-35-366

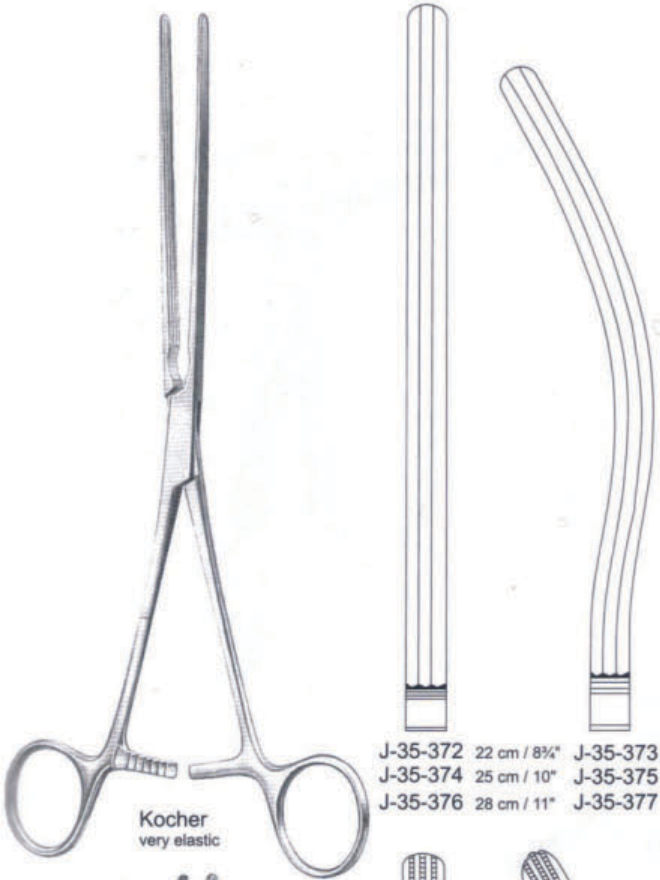

J-35-372 22 cm / 8 1/2" J-35-373
J-35-374 25 cm / 10" J-35-375
J-35-376 28 cm / 11" J-35-377



J-35-378 13 cm / 5" J-35-384
J-35-379 16 cm / 6 1/4" J-35-385
J-35-381 18 cm / 7" J-35-386
J-35-382 21 cm / 8 1/4" J-35-387
J-35-383 23 cm / 9" J-35-388

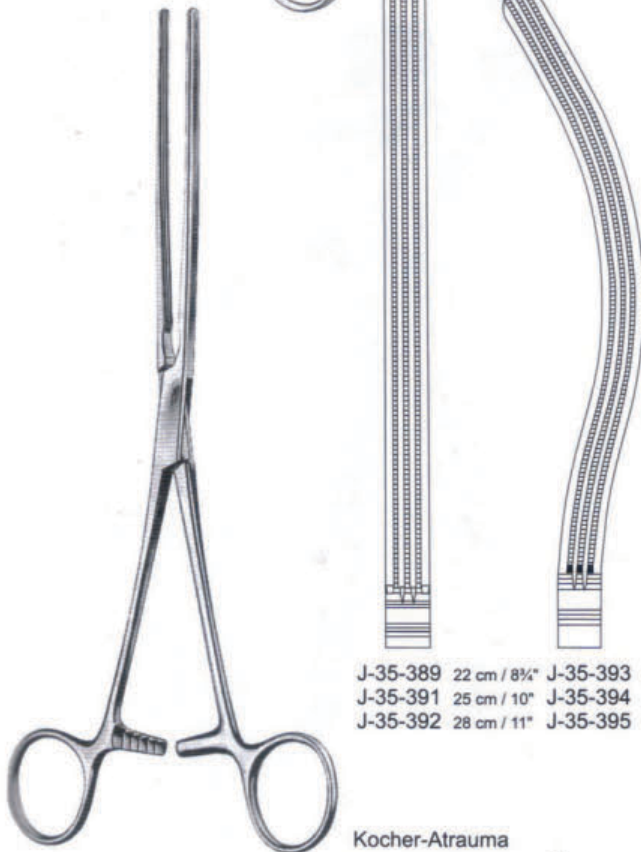

J-35-389 22 cm / 8 1/2" J-35-393
J-35-391 25 cm / 10" J-35-394
J-35-392 28 cm / 11" J-35-395

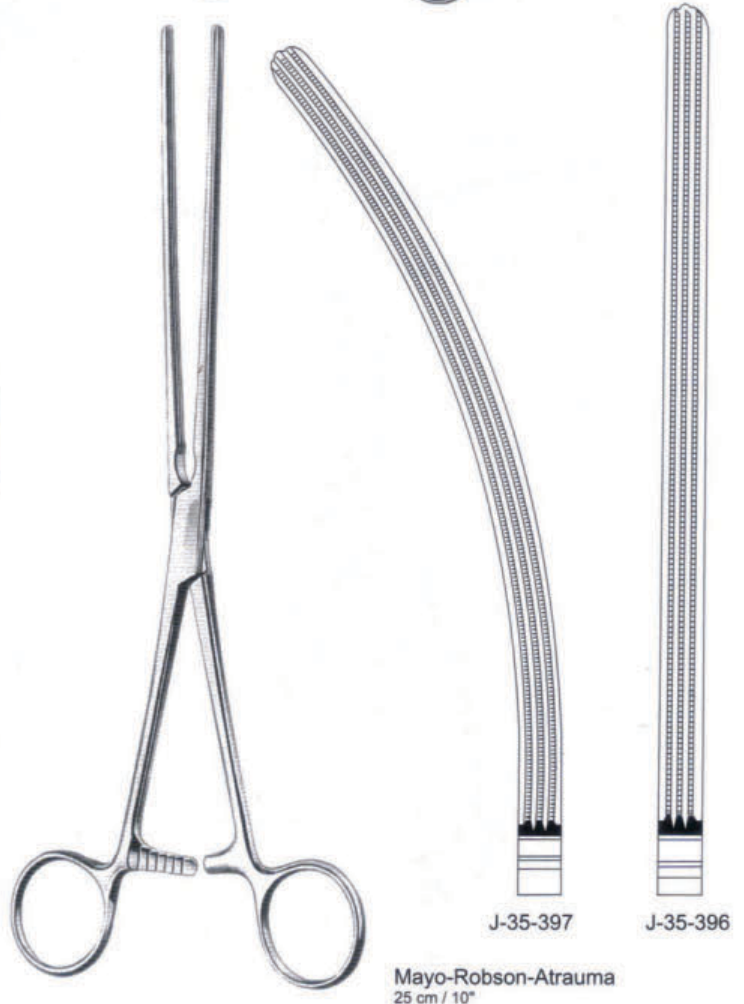



Sims
J-36-002
15 cm / 6"



Sims
J-36-003
15 cm / 6"

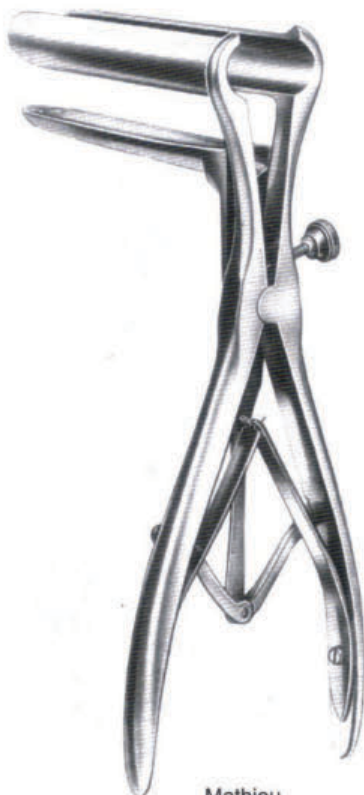

Mathieu
J-36-005
19.5 cm / 7 3/4"



Pratt
J-36-020
20.5 cm / 8"



Mayo
J-23-092
14 cm / 5½"



Mayo
J-23-093
14 cm / 5½"



Universal
J-39-224 20 cm / 8"
J-39-225 28 cm / 11"



J-38-237



Cheate
J-39-241
27 cm / 10½"

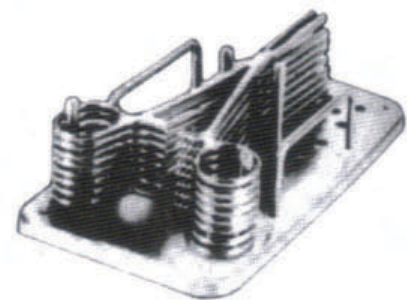

J-39-249

Orthopedic



Esmarch
Jo-21-100
18 cm / 7"



Reiner
Jo-21-101
18.5 cm / 7¼"



Engel
Jo-21-104

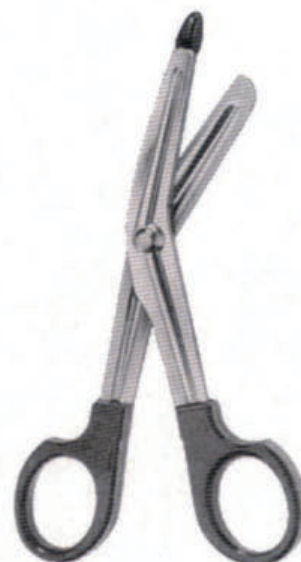

Jo-21-105	black	Jo-21-108	yellow
Jo-21-106	red	Jo-21-109	orange
Jo-21-107	blue	Jo-21-110	bright pink
14.5 cm / 5¾"			



Jo-21-111	black	Jo-21-114	yellow
Jo-21-112	red	Jo-21-115	orange
Jo-21-113	blue	Jo-21-116	bright pink
18 cm / 7"			



Knowles
Jo-21-117
Jo-21-117-A (angled)
14 cm / 5½"

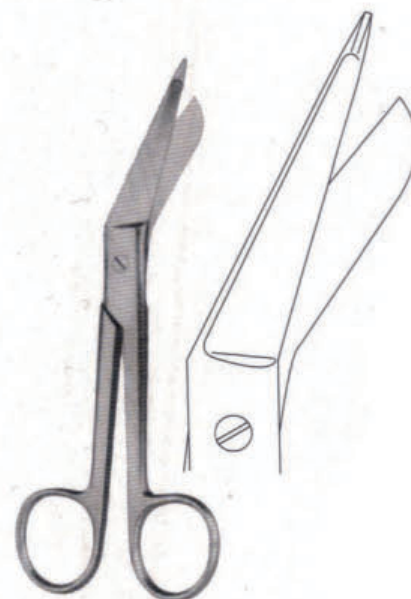

Lister
Jo-21-118 9 cm / 3½"
Jo-21-119 11 cm / 4½"
Jo-21-120 14 cm / 5½"
Jo-21-121 16 cm / 6¼"
Jo-21-122 18 cm / 7"
Jo-21-123 20 cm / 8"



Esmarch
Jo-21-124 20 cm / 8"
Jo-21-125 22 cm / 8¾"

Bergmann
Jo-21-126
23 cm / 9"

Smith [Mod. USA]
Jo-21-127
20 cm / 8"

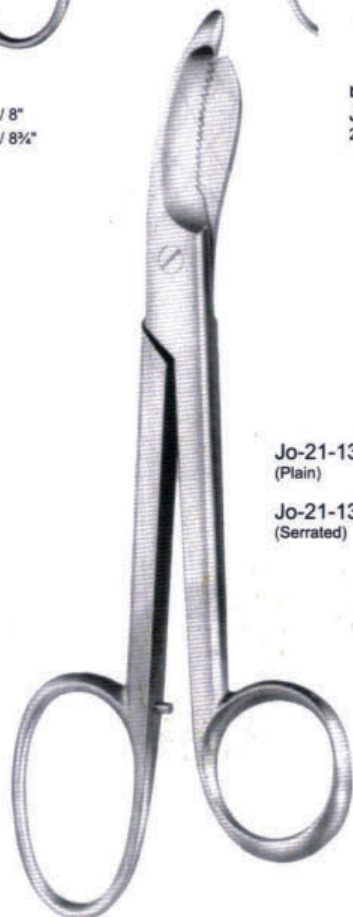

Jo-21-132
(Plain)

Jo-21-133
(Serrated)

Bruns
23.5 / 9¼"

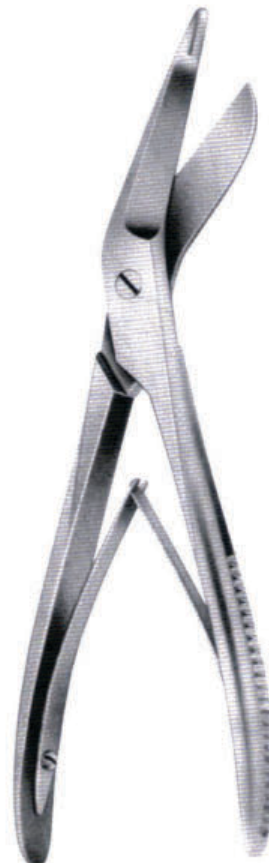

Seutin
Jo-21-134
23 cm / 9"

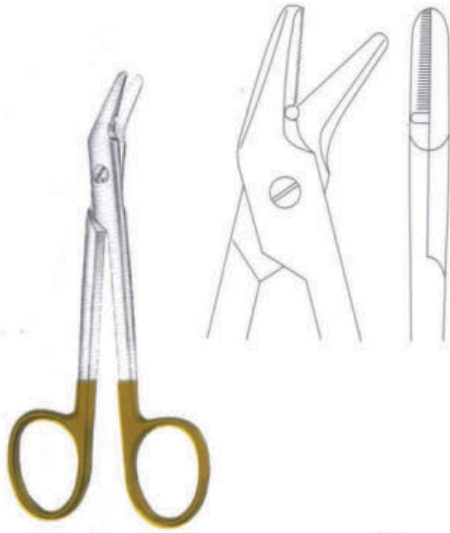

Universal
JT-22-711
12 cm / 5"

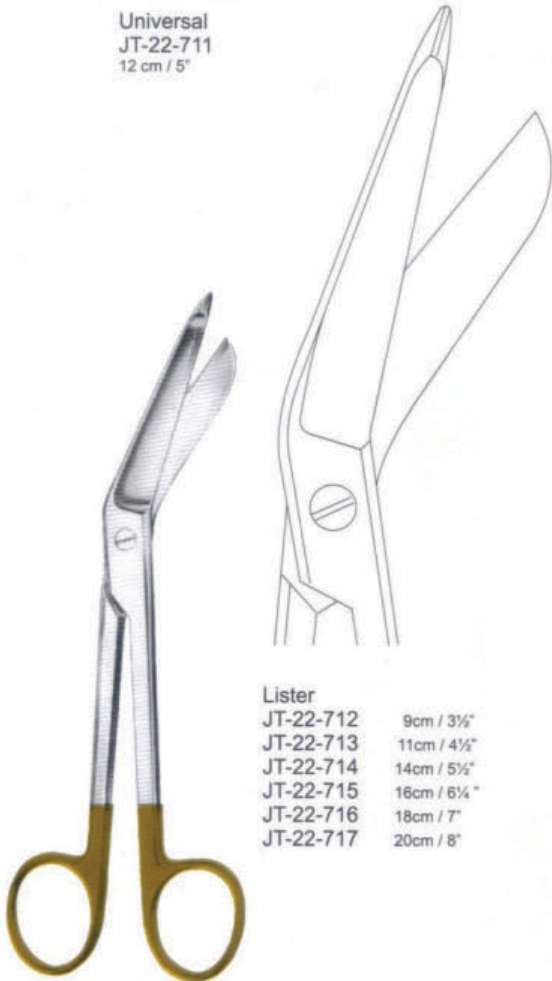

Lister
JT-22-712 9cm / 3½"
JT-22-713 11cm / 4½"
JT-22-714 14cm / 5½"
JT-22-715 16cm / 6¼"
JT-22-716 18cm / 7"
JT-22-717 20cm / 8"



Bruns
JT-22-718
24 cm / 9 ½"



Wolf



Jo-21-143
18 cm / 7"



Jo-21-144
24 cm / 9½"

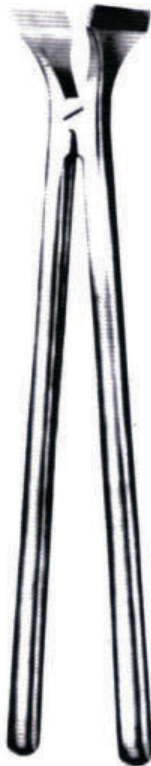

Beeson
Jo-21-145
30 cm / 12"



Hennig
Jo-21-146
28 cm / 11"

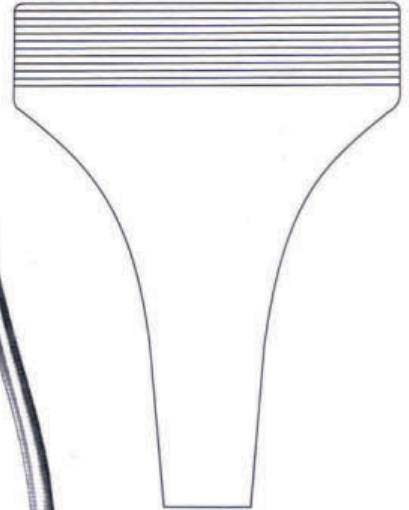

Stille

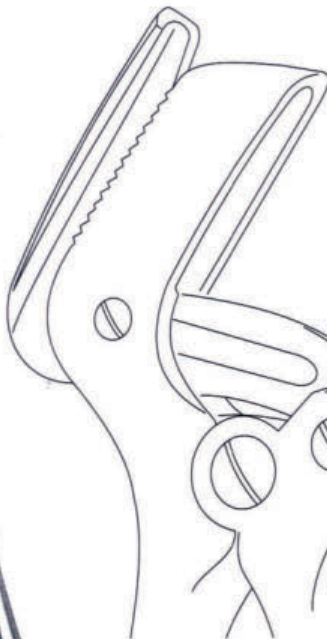

Jo-21-153
23 cm / 9"
Jo-21-153A
Blade without reinforced back

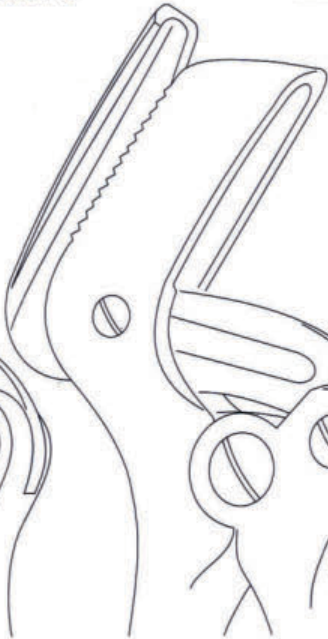

Jo-21-154
26 cm / 10¼"
Jo-21-154A
Blade without reinforced back

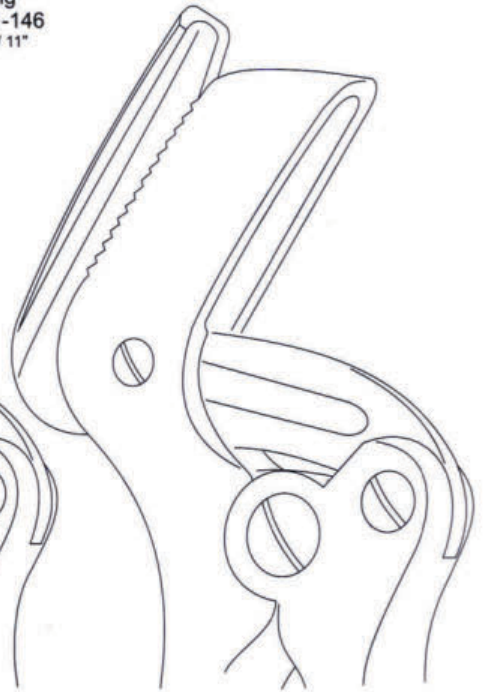

Jo-21-155
37 cm / 14½"
Jo-21-155A
Blade without reinforced back



20 mm Ø
140 g
(5 oz)

Jo-21-156
16.5 cm / 6½"



30 mm Ø
220 g
(7¾ oz)

Collin
Jo-21-157
20 cm / 8"



Williger
24 cm / 9½"

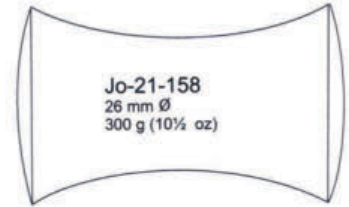

Jo-21-158
26 mm Ø
300 g (10½ oz)

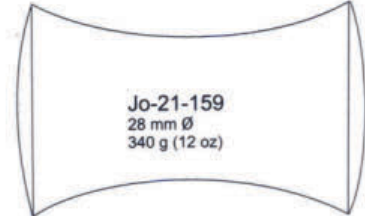

Jo-21-159
28 mm Ø
340 g (12 oz)



Jo-21-160
30 mm Ø
400 g (14 oz)



Lucae
19 cm / 7½"

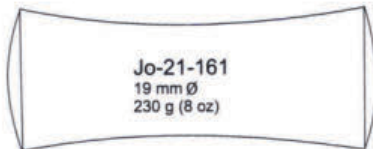

Jo-21-161
19 mm Ø
230 g (8 oz)

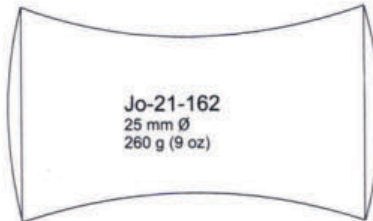

Jo-21-162
25 mm Ø
260 g (9 oz)



Doyen
21 cm / 8¼"

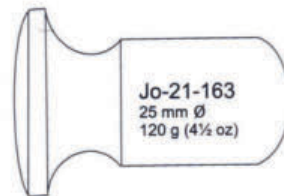

Jo-21-163
25 mm Ø
120 g (4½ oz)

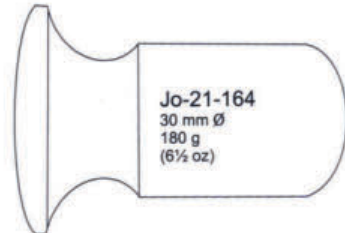

Jo-21-164
30 mm Ø
180 g
(6½ oz)

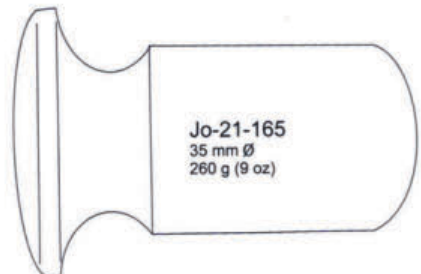

Jo-21-165
35 mm Ø
260 g (9 oz)

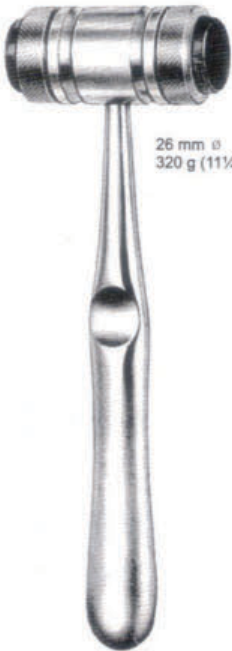

26 mm \varnothing
320 g (11¼ oz)

Mead
Jo-21-166
Solid
Jo-21-167 17 cm / 6¾"
Ferroze II Faces only, pair



22 mm \varnothing
200 g (7 oz)

Partsch
Jo-21-168
18 cm / 7"



40 mm \varnothing

Heath
Jo-21-169
18.5 cm, 7½"
700 g
copper filled head



Autoclavable to
250° F (121° C)

Mallet Lightweight
Jo-21-170
19 cm / 7½" with two replaceable
nylon caps anodized aluminum handle
weight: 7 oz.
head weight: 4 oz
head diameter: 25 mm



Autoclavable to
250° F (121° C)

Combination Mallet
with one nylon cap and one solid stainless side
Jo-21-171 Jo-21-172
19 cm / 7½" 19 cm / 7½"
weight: 9 oz weight: 12 oz
head weight: 5 oz head weight: 8 oz
head diameter: 26 mm head diameter: 38 mm

450 g (1 lb)



Jo-21-173
26 cm / 10½"

30 mm Ø
510 g (18 oz)



Jo-21-175
26 cm / 10½"

900 g (2 lbs)



Jo-21-176
26 cm / 10½"



Aufricht Rasp
21 cm / 8 1/4"



Jo-21-191
Single ended
forward cutting
9 mm width

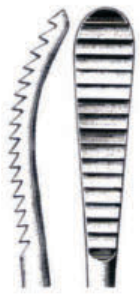

Jo-21-192
Single ended
backward cutting
9 mm width



Maltz Rasp
Jo-21-193
18 cm / 7" Single ended
backward cutting
10 mm width



Joseph Rasp
Jo-21-194
16 cm / 6 1/4" Single ended
8 mm at wide point
fine cross serrations

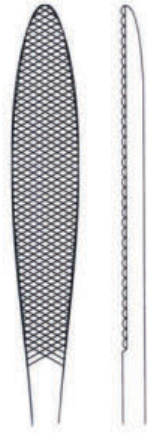

Jo-21-1137
Excision
Arthroplasty Rasp
17 cm / 6 1/2"
stainless steel



Jo-21-1136
Trochlear Rasp
17 cm / 6 1/2"
stainless steel



Lewis Rasp
Jo-21-195
19 cm / 7 1/2"
fine Single ended
8 mm width



Plain Serrations
Jo-21-196
19 cm / 7 1/2" coarse
Single ended
8 mm width



Cottle Rasp
Jo-21-197
20.5 cm / 8"
single ended, backward cutting
9 mm width, plain serration

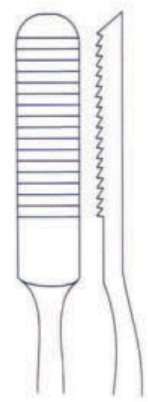



Olivecrona
 Jo-21-212 30 cm, 12°
 Jo-21-213 40 cm, 16°
 Jo-21-214 50 cm, 20°
 Jo-21-215 70 cm, 28°



Gigli
 Jo-21-216 30 cm, 12°
 Jo-21-217 40 cm, 16°
 Jo-21-218 50 cm, 20°
 fine, 6 wires twisted
 Jo-21-219 50 cm, 20°



Gigli-Handle
 Jo-21-220

Blade
 23 cm



Charriere
 Jo-21-223
 35 cm / 14°

Blade
 1. 14 cm
 2. 18 cm
 3. 20 cm



Charriere / Fergusson
 1. Jo-21-224 23 cm
 2. Jo-21-224A 26 cm
 3. Jo-21-224B 30 cm

Blade
 23 cm



Satterlee
 Jo-21-225

Blade
 25cm



Helferich-Bier
 Jo-21-226



SV-0651-30
30 cm
Blade 20 cm
Post Mortem Saw



Butcher
SV-0652-00
Blade 45 cm
Post Mortem Saw



SV-0653-00
Blade 40 cm
Post Mortem Saw

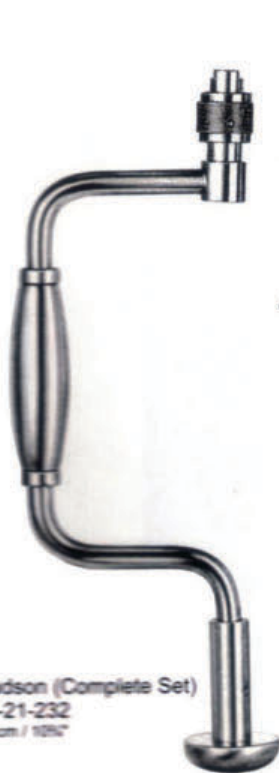

Hudson (Complete Set)
Jo-21-232
27 cm / 10 5/8"



Jo-21-233



Jo-21-234
9 mm ø



Jo-21-235
14 mm ø



Jo-21-236
16 mm ø



Jo-21-237
22 mm ø



Jo-21-238
14 mm ø



Jo-21-239
2 mm ø



Jo-21-240
13 mm ø



Jo-21-241
16 mm ø



Jo-21-264
Handle with chuck and Key, accommodating up to 6.35 mm (1/4"), perforated, for inserting and extracting nails, guide pins, and wire guide drills.



Ralk
Jo-21-261



Jo-21-1133k

Jo-21-1133
Pin Chuck
15 cm up to 6.35 mm diameter
14 cm up to 4.50 mm diameter

- To introduce bone pin
- with jacob chuck
- fully cannulated
- autoclave able



Jo-21-1134

Screw Drivers (Ferozell Handle)



2.5 mm



3.5 mm



Jo-21-265
17 cm / 6 3/4"



Lane
Jo-21-266
25 cm / 10"



Jo-21-267
17 cm / 6 3/4"
Jo-21-267A
25 cm / 10"



Jo-21-268
17 cm / 6 3/4"
Jo-21-268A
25 cm / 10"



Hexagon
Jo-21-269
17 cm / 6 3/4"
Jo-21-269A
25 cm / 10"



Hexagon
Jo-21-270
17 cm / 6 3/4"
Jo-21-270A
25 cm / 10"



Martini
Jo-21-276 B
140 mm, 5½"



Williger
Jo-21-278
145 mm, 5¾"



Volkman
Jo-21-281
145 mm, 5¾"



Volkman
Jo-21-282
170 mm, 6¾"

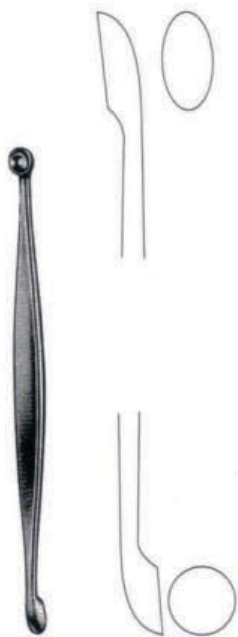

Jo-21-284
160 mm, 6¼"



Volkman
170 mm, 6¾"



Jo-21-286
Fig. 0000



Jo-21-287
Fig. 000



Jo-21-288
Fig. 00



Jo-21-289
Fig. 0



Jo-21-290
Fig. 1



Jo-21-291
Fig. 2



Jo-21-292
Fig. 3



Jo-21-293
Fig. 4



Jo-21-294
Fig. 5



Jo-21-295
Fig. 6



- Jo-21-513B 4 mm
- Jo-21-513C 8 mm
- Jo-21-513D 10 mm
- Jo-21-513E 13 mm
- Jo-21-513 15 mm
- Jo-21-513F 18 mm
- Jo-21-514 20 mm
- Jo-21-515 25 mm
- Jo-21-516 30 mm
- Jo-21-517 38 mm
- Jo-21-518 44 mm
- Jo-21-519 50 mm

Lambotte-Osteotome
25 cm, 10"



- Jo-21-501 4 mm
- Jo-21-502 6 mm
- Jo-21-503 8 mm
- Jo-21-504 10 mm
- Jo-21-505 12 mm
- Jo-21-505A 15 mm

Mini-Lambotte-Osteotome
12.5 cm / 5"



Mini-Lexer
18 cm, 7"

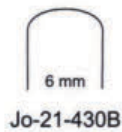
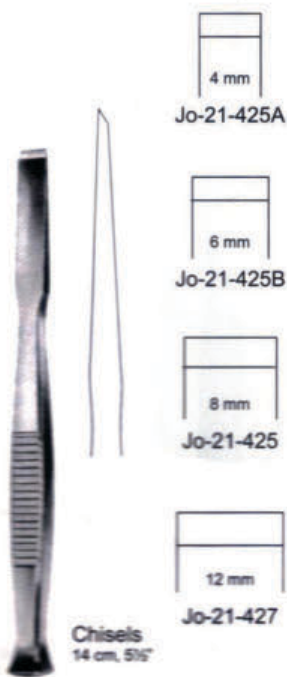
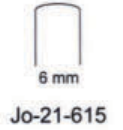
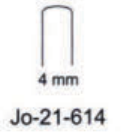
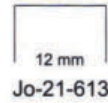
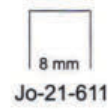



- Jo-21-521 10 mm
- Jo-21-522 12 mm
- Jo-21-523 15 mm
- Jo-21-524 20 mm
- Jo-21-525 25 mm

Stille-Chisels
20.5 cm, 8"



- Jo-21-526 10 mm
- Jo-21-527 12 mm
- Jo-21-528 15 mm
- Jo-21-529 20 mm
- Jo-21-530 25 mm

Stille-Gouges
20.5 cm, 8"



- Jo-21-531 10 mm
- Jo-21-532 12 mm
- Jo-21-533 15 mm
- Jo-21-534 20 mm
- Jo-21-535 25 mm

for taking grafts from the ribs

Stille-Gouges
20.5 cm, 8"



- Jo-21-535A 8 mm
- Jo-21-535B 10 mm
- Jo-21-535C 12 mm
- Jo-21-536 15 mm
- Jo-21-537 20 mm
- Jo-21-538 25 mm

Stille-Osteotomes
20.5 cm, 8"



- Jo-21-539 10 mm
- Jo-21-540 12 mm
- Jo-21-541 15 mm
- Jo-21-542 20 mm
- Jo-21-543 25 mm

Stille-Osteotomes
20.5 cm, 8"



- Jo-21-544 10 mm
- Jo-21-545 12 mm
- Jo-21-546 15 mm
- Jo-21-547 20 mm
- Jo-21-548 25 mm

Stille-Osteotomes
20.5 cm, 8"
curved



Jo-21-670 B
170 mm, 6 $\frac{3}{4}$ "



Williger
Jo-21-690
140 mm, 5 $\frac{1}{2}$ "



Konig
Jo-21-690 A
155 mm, 6"



Williger
Jo-21-691
160 mm, 6 $\frac{1}{4}$ "



Jo-21-717
185 mm, 7 $\frac{1}{4}$ "



Jo-21-718
185 mm, 7 $\frac{1}{4}$ "



Jo-21-719
185 mm, 7 $\frac{1}{4}$ "

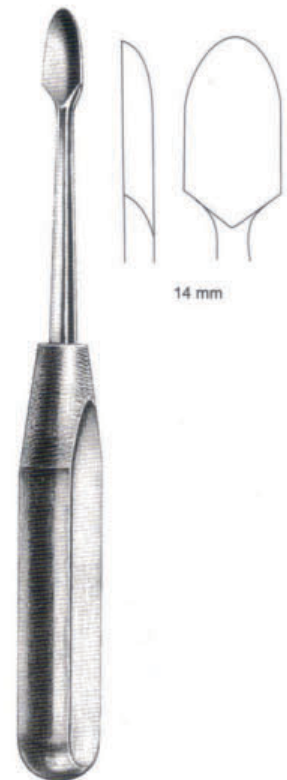

Jo-21-720
195 mm, 7 $\frac{3}{4}$ "



Freer
J-32-1300
185 mm, 7¼"
Sharp/blunt



Jo-21-724 A
150 mm, 6"



Jo-21-724 B
150 mm, 6"

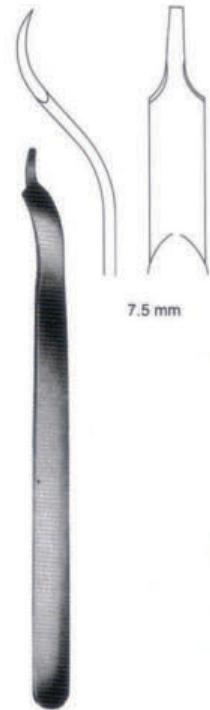

Buck-Gramcko
Jo-21-724 C
150 mm, 6"



Williger
Jo-21-669
175 mm, 7"

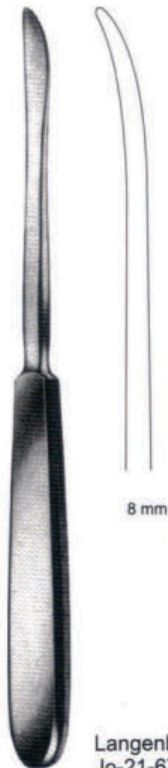

Langenbeck
Jo-21-673
200 mm, 8"

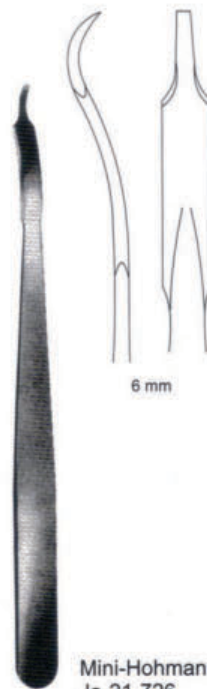

Mini-Hohmann
Jo-21-726
160 mm, 6¼"

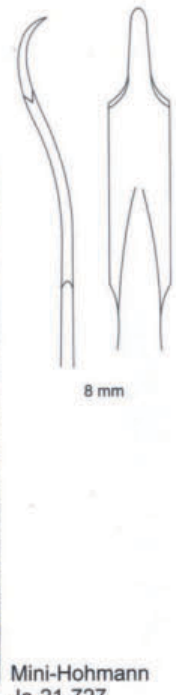

Mini-Hohmann
Jo-21-727
160 mm, 6¼"



Hohmann
Jo-21-728
8 mm

Hohmann
Jo-21-729
18 mm

Hohmann
Jo-21-730
43 mm

Hohmann
Jo-21-731
70 mm



Hohmann
Jo-21-732
43 mm

Hohmann
Jo-21-733
22 mm

Hohmann
Jo-21-734
33 mm

Hohmann
Jo-21-735
24 mm

Hohmann
Jo-21-736
22 mm

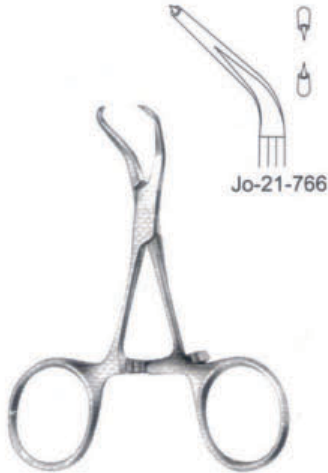

Jo-21-766

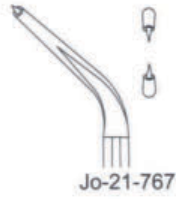

Jo-21-767

Reposition forceps
with stepped tips
9.5 cm / 3 3/4"



Jo-21-768
13.5 cm, 5 1/2"

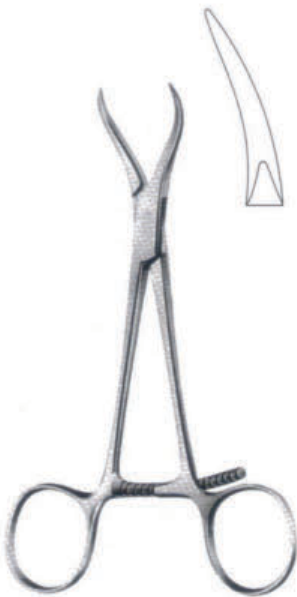

Jo-21-769
Reposition forceps,
especially for maxillary
reposition
13.5 cm, 5 1/4"



Haase
Jo-21-770
Reposition forceps, for
mandibular fractures
16.5 cm, 6 1/2"

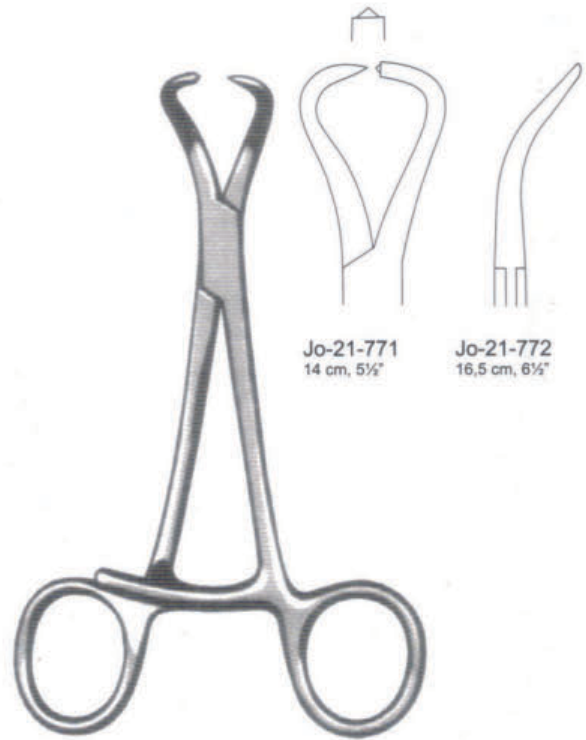

Jo-21-771
14 cm, 5 1/2"

Jo-21-772
16.5 cm, 6 1/2"

Bone Reduction Forceps
Curved

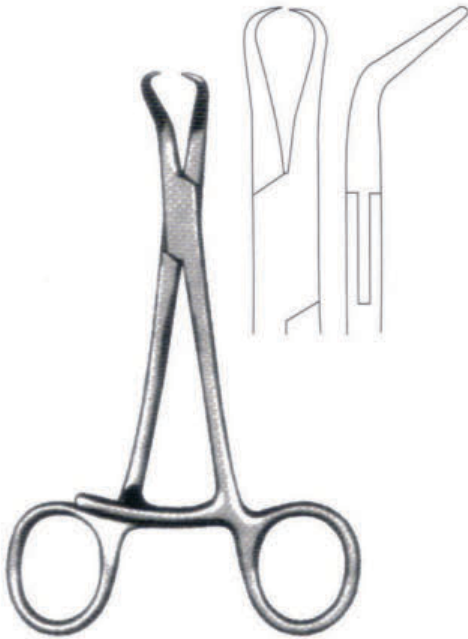

**Stagbeetle Bone
Reduction Forceps**
Jo-21-773
12 cm / 4 3/4" curved
pointed tips

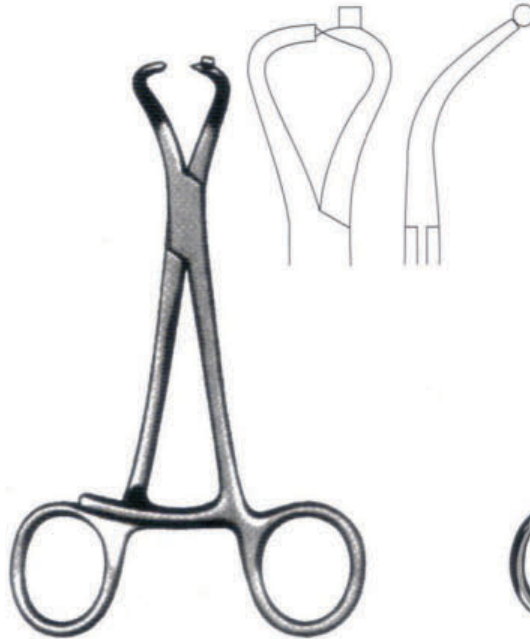

Bone Holding Forceps
Jo-21-774
13 cm, 5 1/4" curved
with 1.6 mm k-wire guide



Bone Holding Forceps
Jo-21-774 A

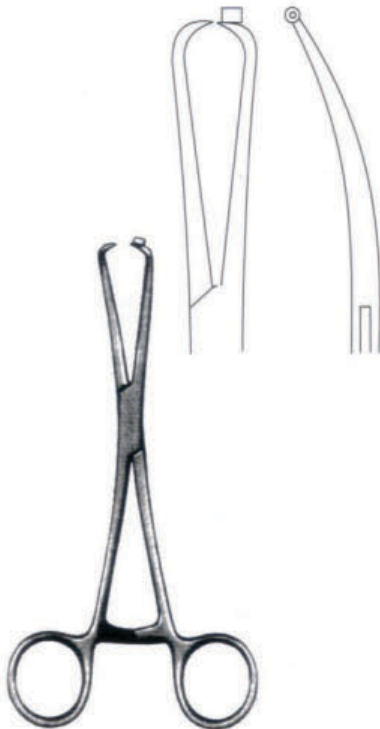

Bone Holding Forcep
Jo-21-775
17 cm, 6 3/4" curved
with 1.1 mm k-wire guide



Jo-21-776
13.5 cm / 5 1/2"

Jo-21-777
12.5 cm / 5"

Bone Holding Forceps
Serrated with pointed tips
curved

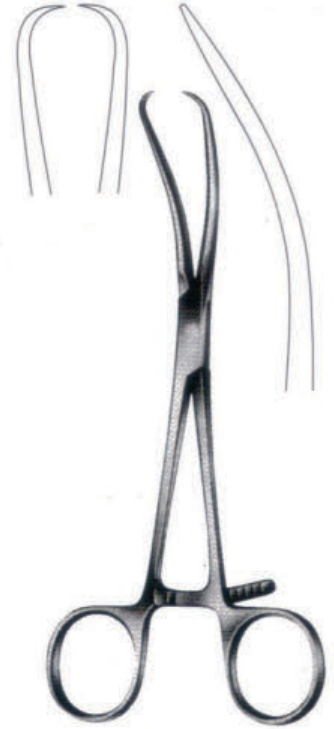

Reil Bone Reduction Forcep
Jo-21-778
17,5 cm, 7" curved
pointed tips



Bone Reduction Forcep
Jo-21-779
20 cm, 8"



1 x 1 sharp points
Grasping forceps
for small bones

Malleolar Forcep
Jo-21-780
21 cm, 8 1/4"

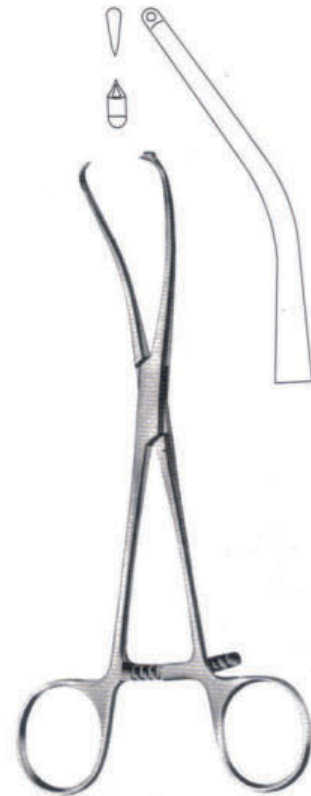

Meyer
Jo-21-781
17 cm, 6 1/2"
Reposition forcep for gers,
with drill guide for kirschner
wires up diameter 1.0 mm

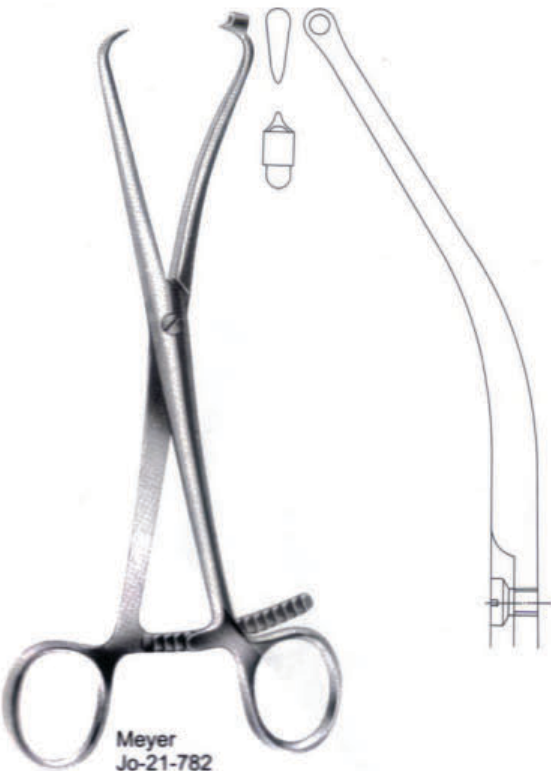

Meyer
Jo-21-782
20.5 cm / 8"
Reposition forceps
with drill guide for kirschner
wires up to diameter 2.0 mm



Jo-21-783
14 cm, 5 1/2"

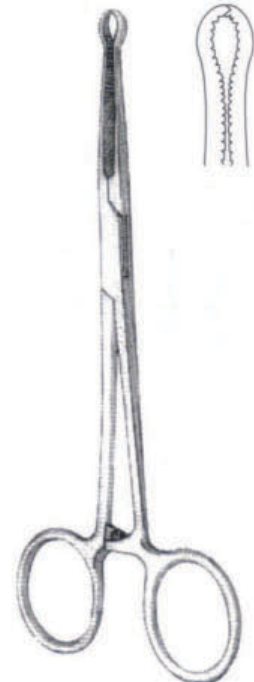

Locke Phalangeal Forcep
Jo-21-784
15 cm, 6"
serrated jaws
1 x 1 teeth



Bone Reduction Forceps
Jo-21-785
14 cm, 5 1/4" small curved
ratchet length: 1 1/4"



Jo-21-786
12 cm, 4 1/4"



Jo-21-786A
19 cm, 7 1/2"



Lewin
Jo-21-787
17.5 cm, 7"

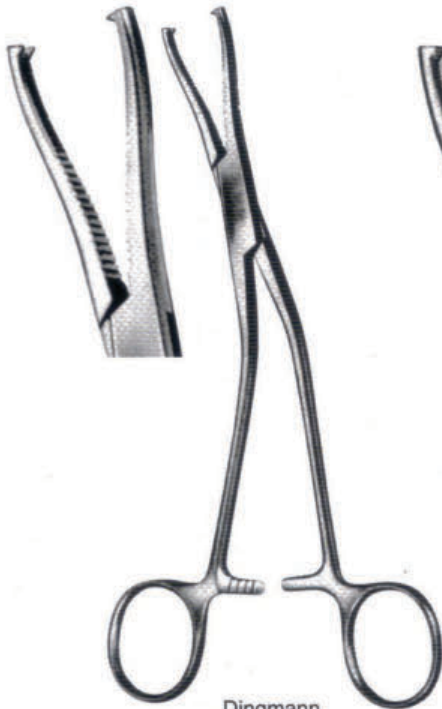

Dingmann
Jo-21-788
18.5 cm, 7 1/4"



Dingmann
Jo-21-789
18.5 cm, 7 1/4"

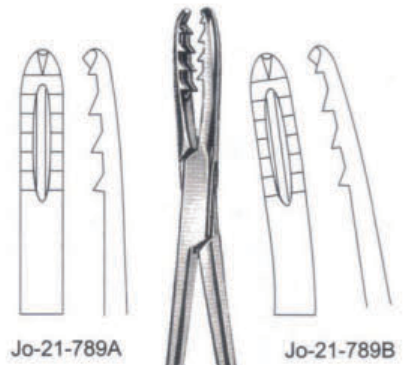

Jo-21-789A

Jo-21-789B

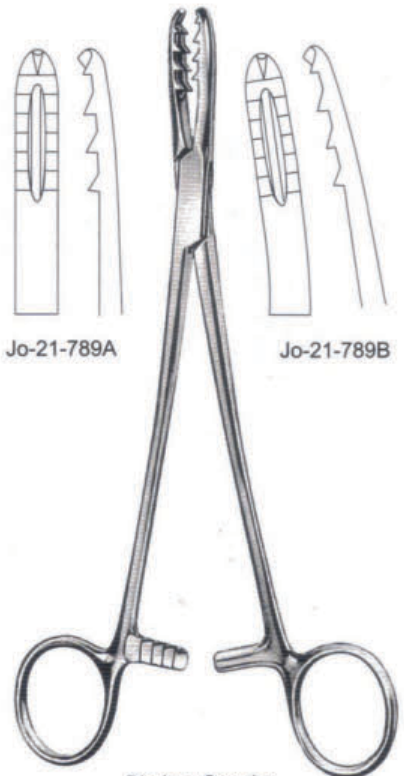

Bircher-Ganske
20 cm, 8"



Kern
 Jo-21-798 12 cm, 4 3/4"
 Jo-21-799 15 cm, 6"
 Jo-21-799A 17 cm, 6 3/4"
 Jo-21-799B 21 cm, 8 1/4"



Kern
 Jo-21-800 12 cm, 4 3/4"
 Jo-21-801 15 cm, 6"
 Jo-21-801A 17 cm, 6 3/4"
 Jo-21-801B 21 cm, 8 1/4"
 with ratchet



Langenbeck
 Jo-21-793
 21 cm / 8 1/4"

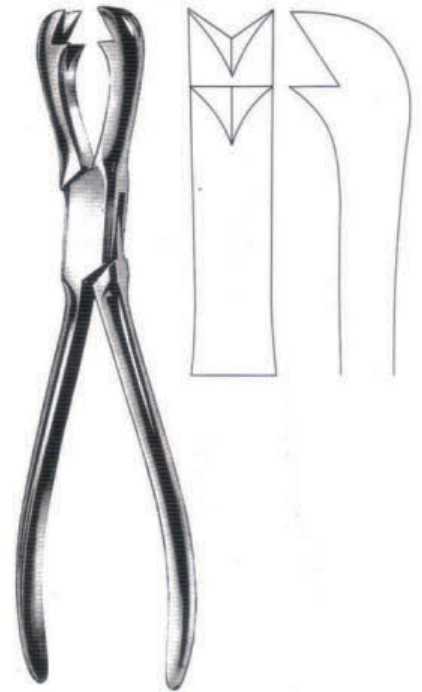

Fergusson
 Jo-21-794
 21 cm / 8 1/4"

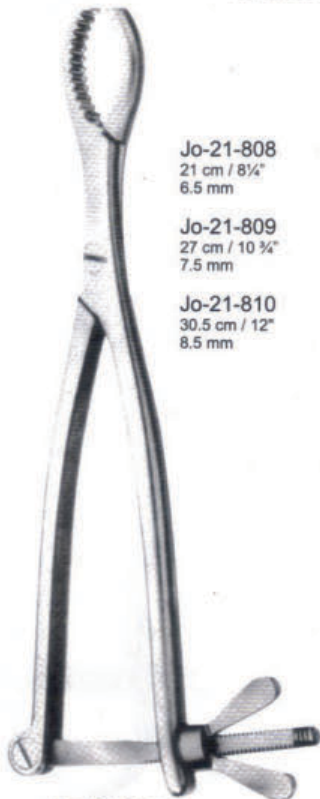

Hey Groves

Jo-21-808
 21 cm / 8 1/4"
 6.5 mm
Jo-21-809
 27 cm / 10 3/4"
 7.5 mm
Jo-21-810
 30.5 cm / 12"
 8.5 mm



Verbrugge Mini
 Jo-21-814
 17.5 cm, 6 3/4"

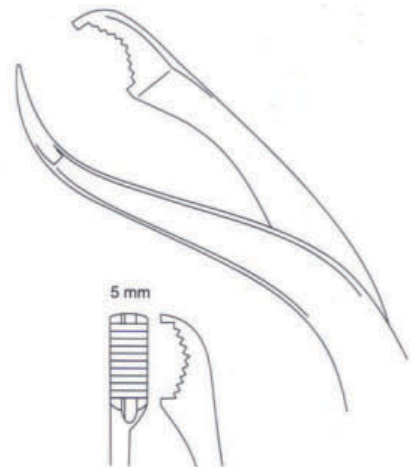

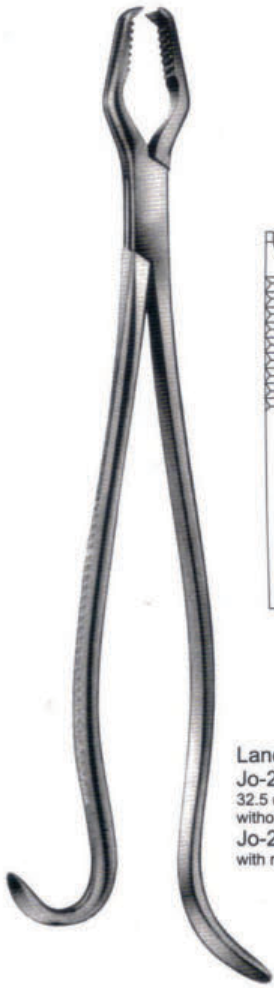

Lane Bone Holding Forceps
Jo-21-802
32.5 cm / 13"
without ratchet, light model
Jo-21-803
with ratchet

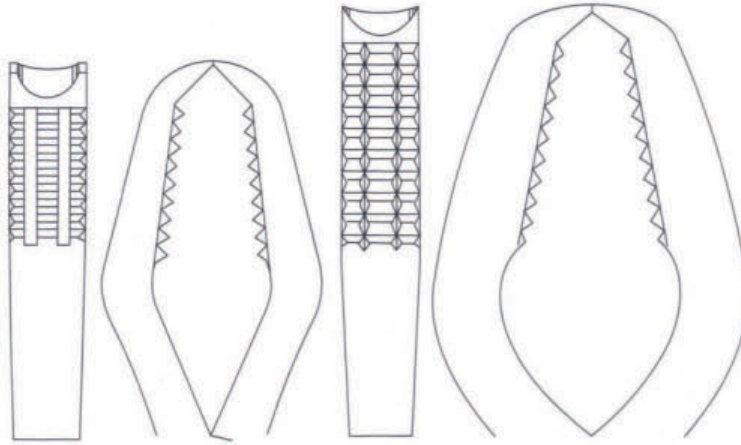

Lane Bone Holding Forceps
Jo-21-804
32.5 cm / 13" Standard Model
without ratchet
Jo-21-805
32.5 cm / 13" Standard Model
with ratchet

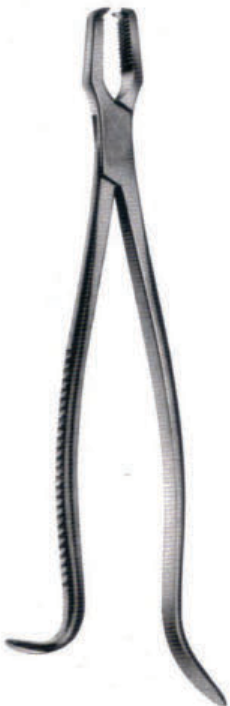

Lane Bone Forceps
Jo-21-806
42.5 cm / 17"
without ratchet

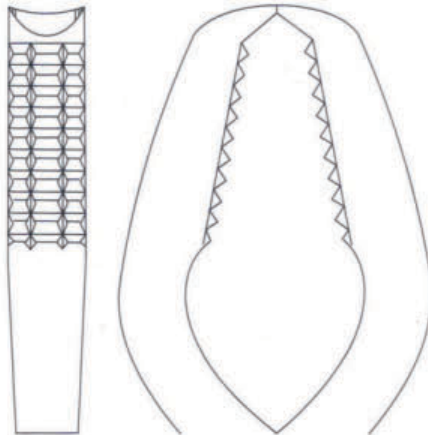

Lane Bone Forceps
Jo-21-807
42.5 cm / 17"
with ratchet

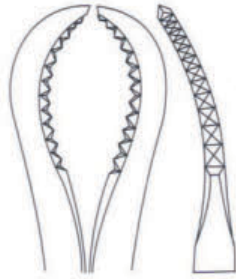

Jo-21-817 16 cm, 6 1/4"
Jo-21-818 24 cm, 9 1/2"

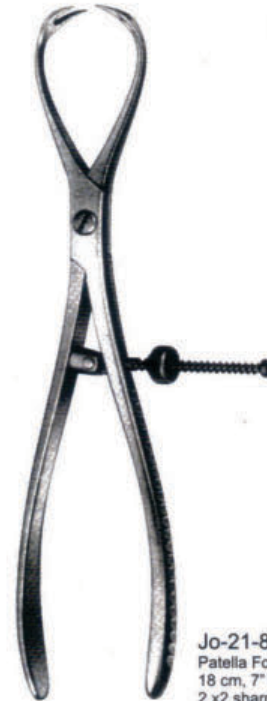

Jo-21-819
Patella Forceps
18 cm, 7" with speed lock
2 x 2 sharp teeth

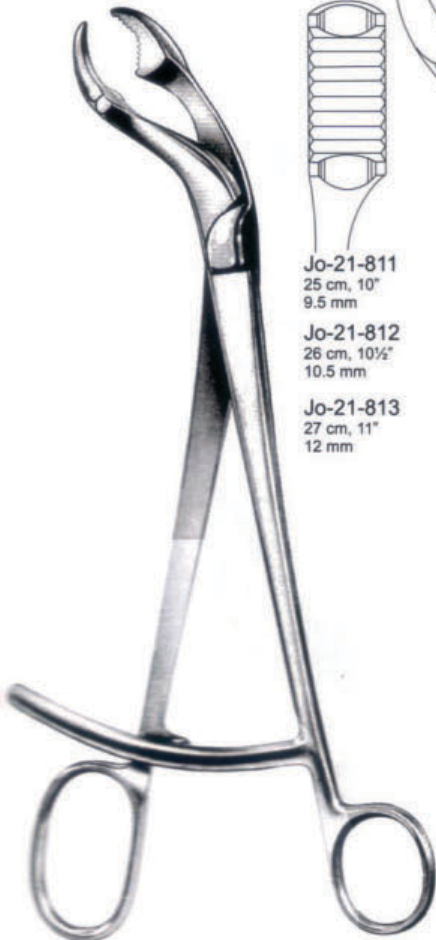

Jo-21-811
25 cm, 10"
9.5 mm
Jo-21-812
26 cm, 10 1/2"
10.5 mm
Jo-21-813
27 cm, 11"
12 mm

Verbrugge

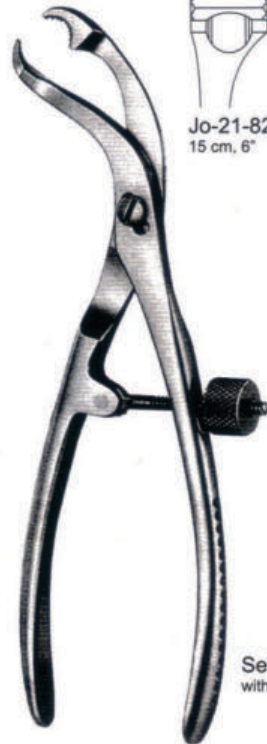

2.5 mm

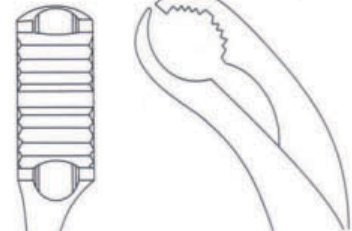

Jo-21-820 15 cm, 6"
Jo-21-821 19 cm, 7 1/2"
Jo-21-822 24 cm, 9 1/2"
Jo-21-823 26 cm, 10 1/4"
Jo-21-824 28 cm, 11"

Jo-21-820-S
Special mini size
12 cm, 4 3/4"

Self-Conforming Forceps
with thread fixation

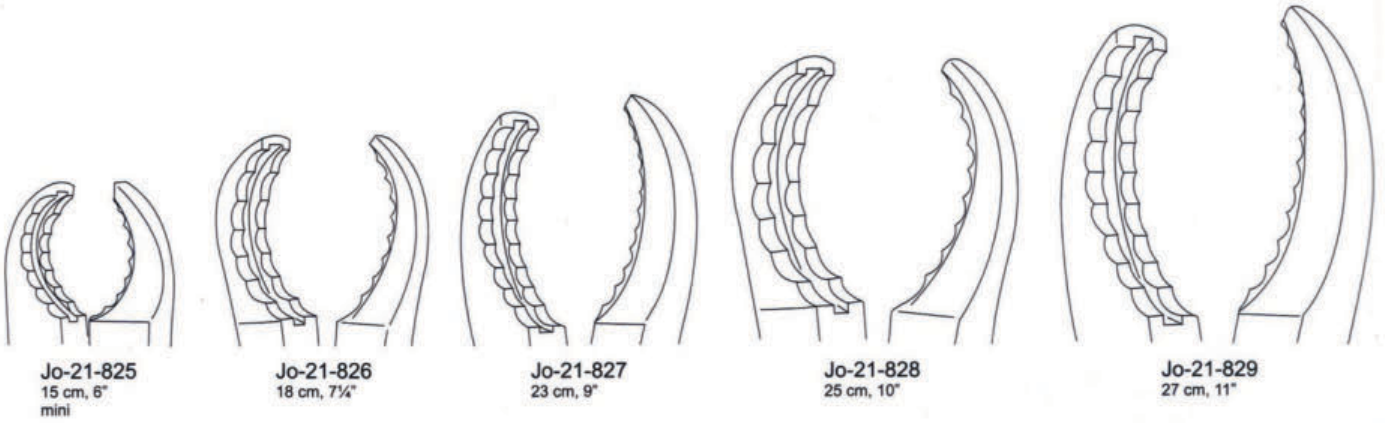

Jo-21-825
15 cm, 6"
mini

Jo-21-826
18 cm, 7¼"

Jo-21-827
23 cm, 9"

Jo-21-828
25 cm, 10"

Jo-21-829
27 cm, 11"

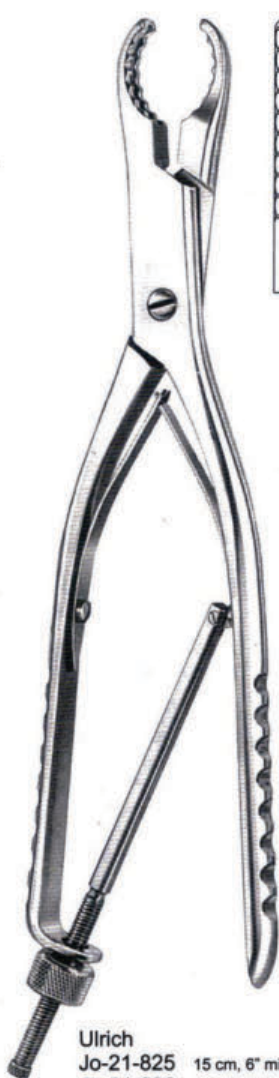

Ulrich
Jo-21-825 15 cm, 6" mini
Jo-21-826 18 cm, 7¼"
Jo-21-827 23 cm, 9"
Jo-21-828 25 cm, 10"
Jo-21-829 27 cm, 11"
Straight

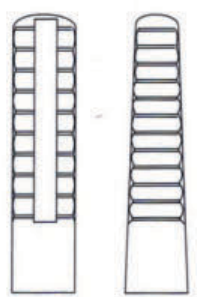

Ulrich
Jo-21-830 15 cm, 6"
Jo-21-830A 18 cm, 7¼"
Jo-21-830B 23 cm, 9"
Jo-21-830C 25 cm, 10"
Jo-21-830D 27 cm, 11"
curved

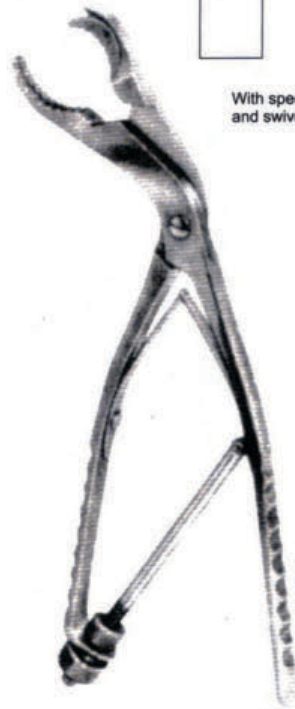
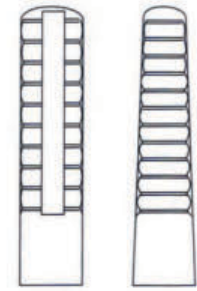

Ulrich Self-Retaining Forceps
Jo-21-831
27 cm, 11"
angular

With speed lock
and swivel jaw

Calibrated in inches

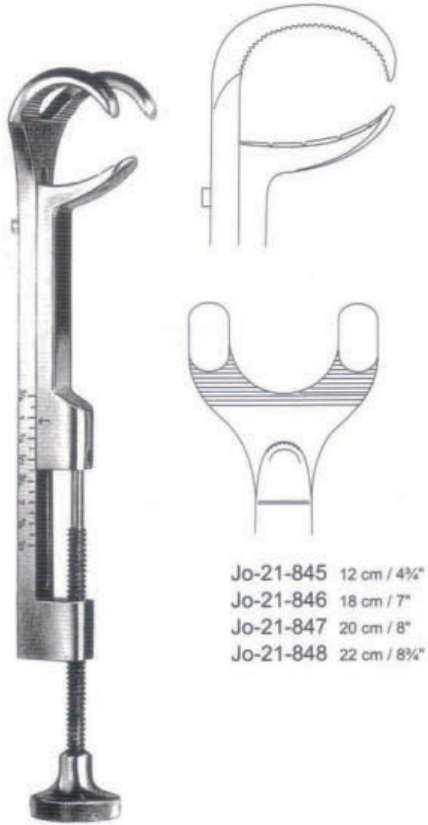

- Jo-21-845 12 cm / 4 1/2"
- Jo-21-846 18 cm / 7"
- Jo-21-847 20 cm / 8"
- Jo-21-848 22 cm / 8 1/2"

Gerster-Lowmann

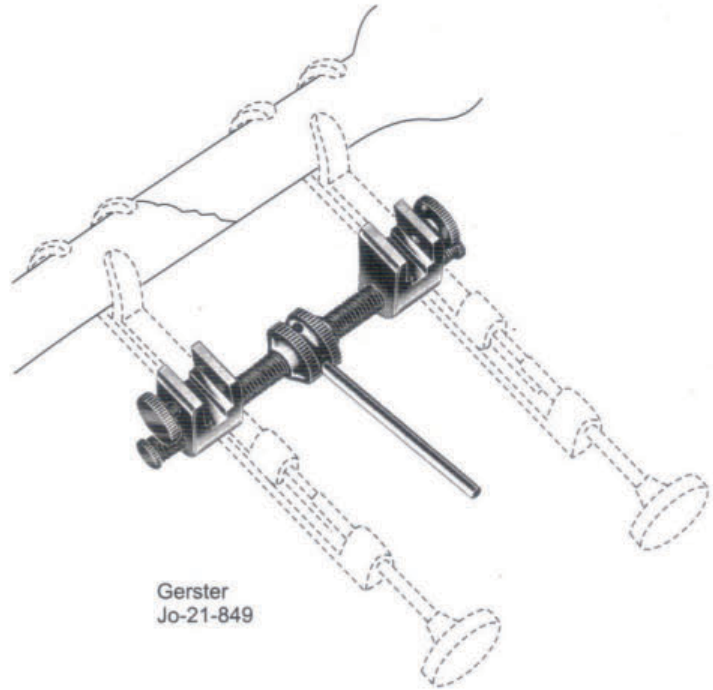

Gerster
Jo-21-849

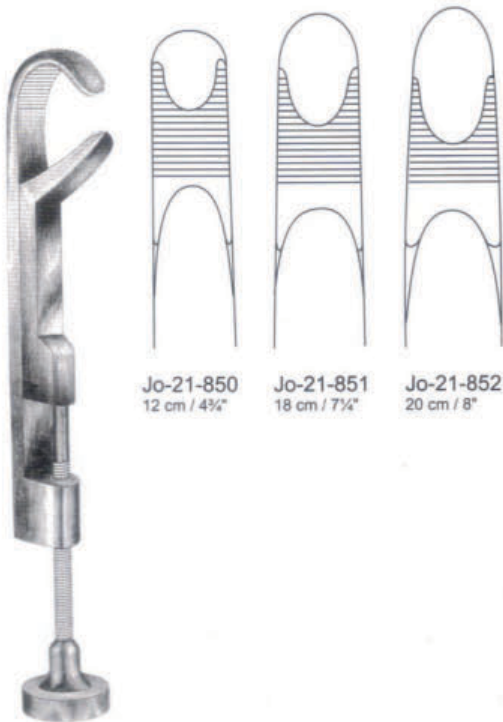

- Jo-21-850 12 cm / 4 1/2"
- Jo-21-851 18 cm / 7 1/4"
- Jo-21-852 20 cm / 8"

Lowmann Bone Clamp
1 X 1 Jaws

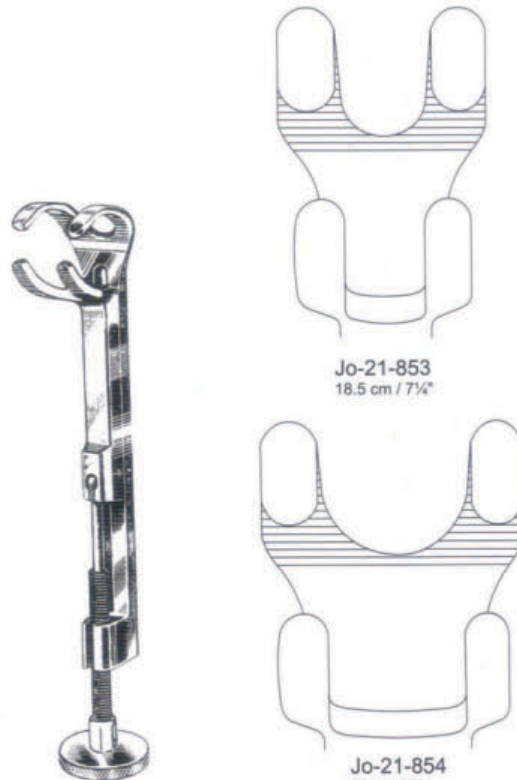

Jo-21-853
18.5 cm / 7 1/4"

Jo-21-854
20 cm / 8"

Lowmann Bone Clamp
2 X 2 Jaws



Mini-Friedman
Jo-21-855
12,5 cm, 5"



Friedman
Jo-21-856
14 cm, 5½"



Mini-Friedman Rongeur
15 cm, 6"
Delicate
2 x 6 mm bite

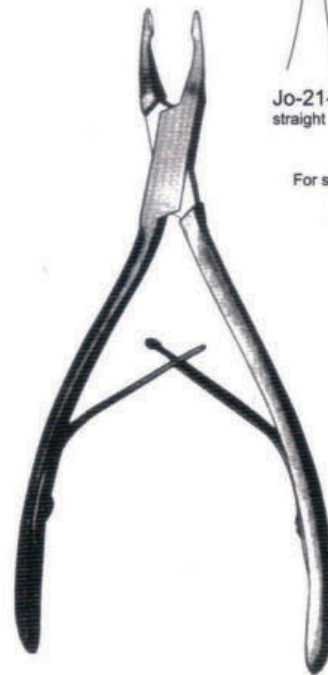

Micro Friedman Rongeur
14 cm, 5½"
extremely delicate
1.5 x 5 mm bite



For soft tissue and cancellous bone only.

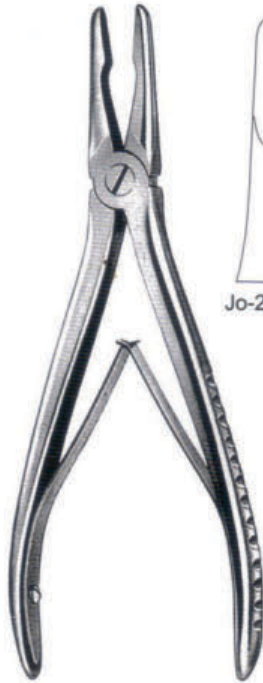

Jansen
18 cm, 7"

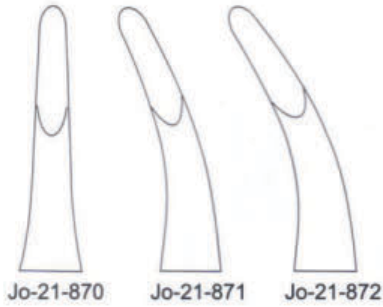

Jo-21-870 Jo-21-871 Jo-21-872



Jansen
18 cm, 7"

Jo-21-873 Jo-21-874



Blumenthal
15 cm, 6"

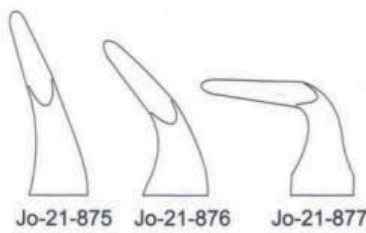

Jo-21-875 Jo-21-876 Jo-21-877

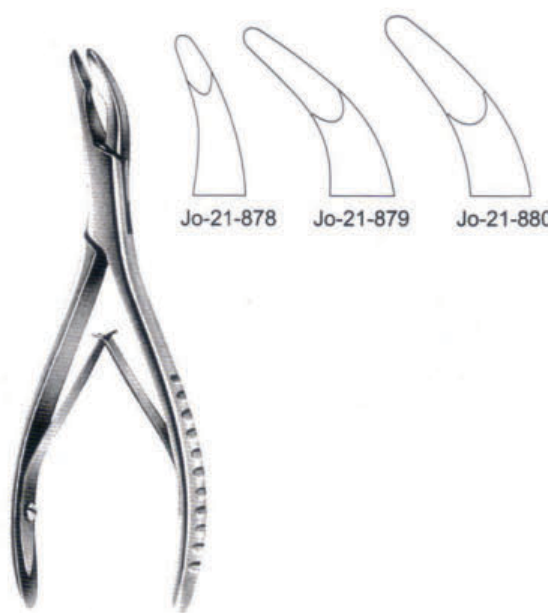

Luer
15 cm, 6"

Jo-21-878 Jo-21-879 Jo-21-880

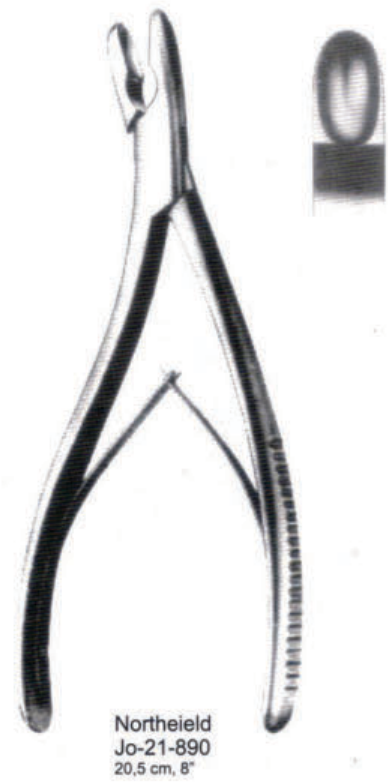
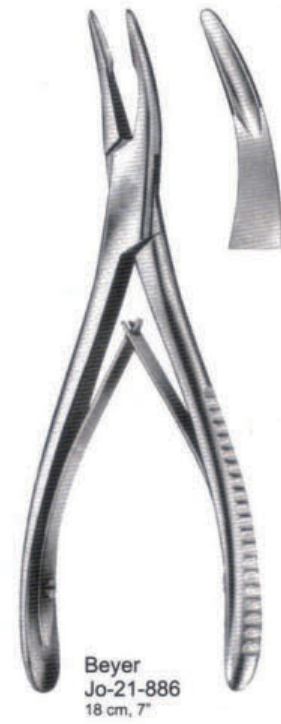
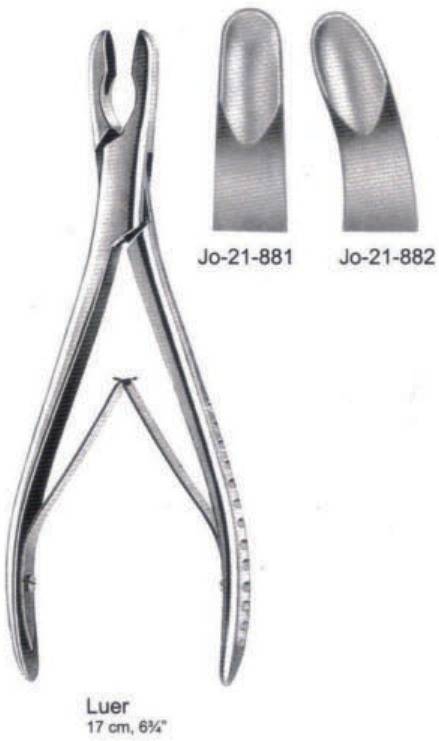



Lempert
19 cm, 7½"



Jo-21-895 Jo-21-894



Bohler
15 cm, 6"



Jo-21-896 Jo-21-897



Zaufal - Jansan
Jo-21-898
18 cm, 7"



Mayfield
Jo-21-899
17 cm, 6¾"



Ruskin

Jo-21-901
15 cm / 6"
Straight, delicate
2 x 14 mm bite

Jo-21-902
18 cm / 7"
straight

Jo-21-903
18 cm / 7"
curved



Ruskin
Jo-21-904
23 cm / 9"



Beyer
Jo-21-900
18 cm / 7"

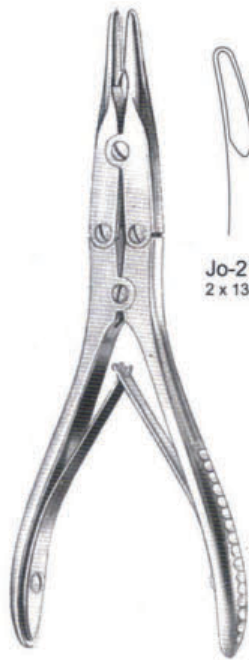

Jo-21-909
2 x 13 mm bite

Kleinert-Kutz
Synovectomy Rongeur
15 cm, 6"



Jo-21-910
3 x 13 mm bite

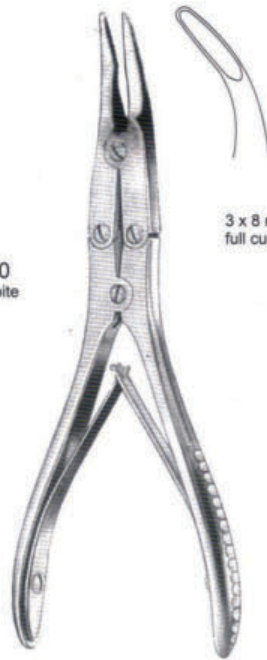

3 x 8 mm bite
full curve delicate

Jo-21-911
15 cm, 6"

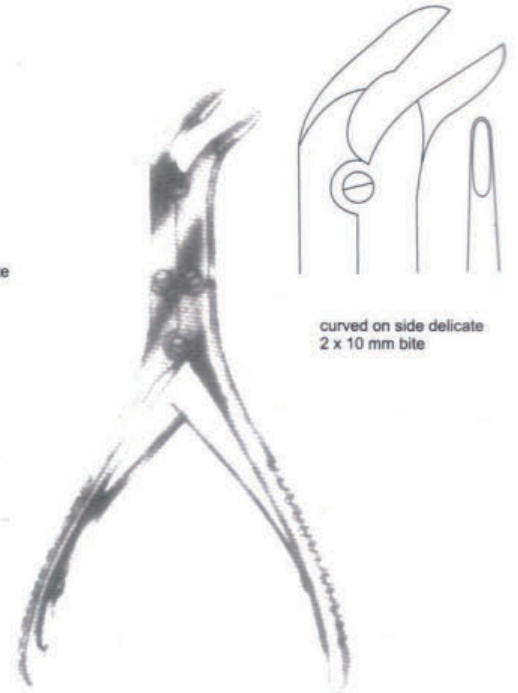

curved on side delicate
2 x 10 mm bite

Kleinert-Kutz
Jo-21-912
15 cm, 6"
Synovectomy Rongeur

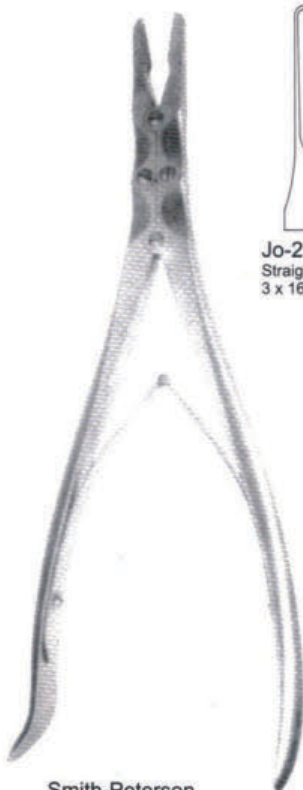

Smith-Peterson
Laminectomy Rongeur
24 cm, 9 1/2"



Jo-21-905
Straight
3 x 16 mm bite



Jo-21-906
Curved
3 x 16 mm bite



Jo-21-907
Full Curved
3 x 16 mm bite



Stille
Jo-21-918
23 cm, 9"

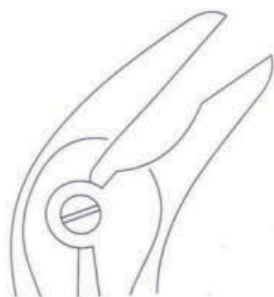

Jo-21-913
2 mm



Jo-21-914
3 mm



Jo-21-915
4 mm



Echlin
23 cm, 9"



Stille- Ruskin
Jo-21-916
23 cm, 9"



Semb
Jo-21-917
22.5 cm, 9"



Jo-21-920
3 x 16 mm bite



Jo-21-921
4 x 16 mm bite



Jo-21-922
5 x 16 mm bite



Jo-21-926
3 x 13 mm bite



Jo-21-927
4 x 13 mm bite



Jo-21-928
5 x 13 mm bite



Jo-21-923
6 x 16 mm bite



Jo-21-924
7 x 16 mm bite



Jo-21-925
8 x 16 mm bite



Jo-21-929
6 x 13 mm bite



Jo-21-930
7 x 13 mm bite



Jo-21-931
8 x 13 mm bite

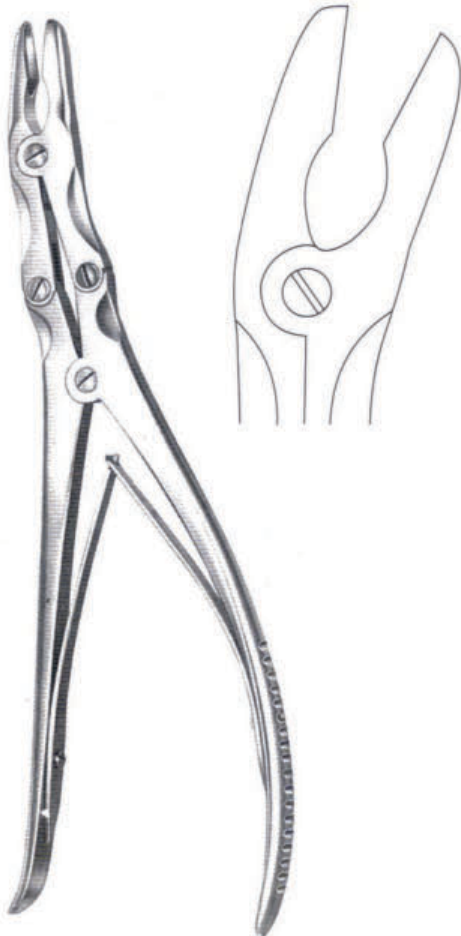

Leksell - Stille
24 cm, 9½"
15° curve



Leksell Rongeur
23 cm, 9"
50° curve



Jo-21-932
8 mm



Jo-21-933
8mm



Stille-Luer
22 cm, 8½"



Jo-21-934
23 cm, 9"

Jo-21-935
27 cm, 10½"



Jo-21-936
23 cm, 9"

Jo-21-937
27 cm, 10½"



Stille-Luer



Jo-21-941
14 cm, 5½"



Jo-21-942
17 cm, 6¾"



Liston



Jo-21-943
19 cm, 7½"



Jo-21-944
22 cm, 8¾"



Jo-21-945
14 cm, 5½"



Jo-21-946
17 cm, 6¾"



Liston



Jo-21-947
19 cm, 7½"



Jo-21-948
22 cm, 8¾"



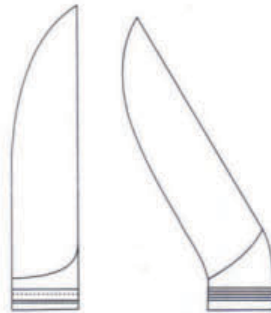

Jo-21-965

Jo-21-966

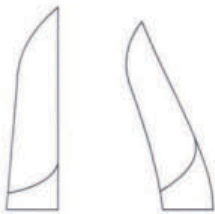

Jo-21-962

Jo-21-963



Ruskin-Liston
18.5 cm / 7 1/2"

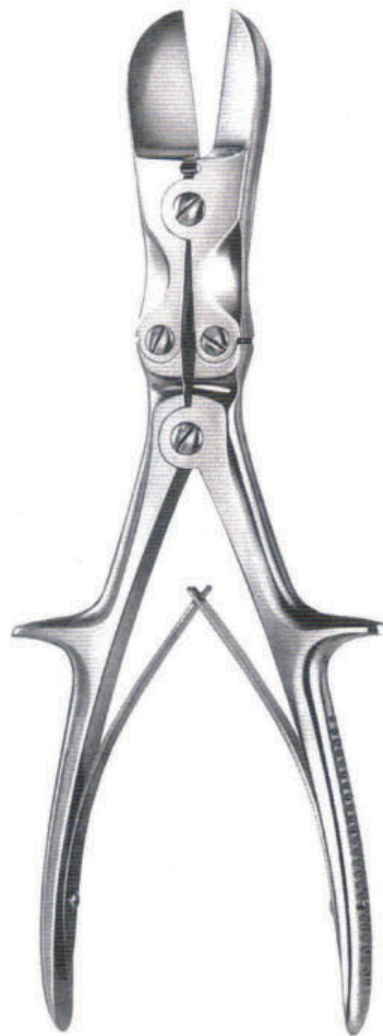

Stille Liston
27 cm, 10 1/2"

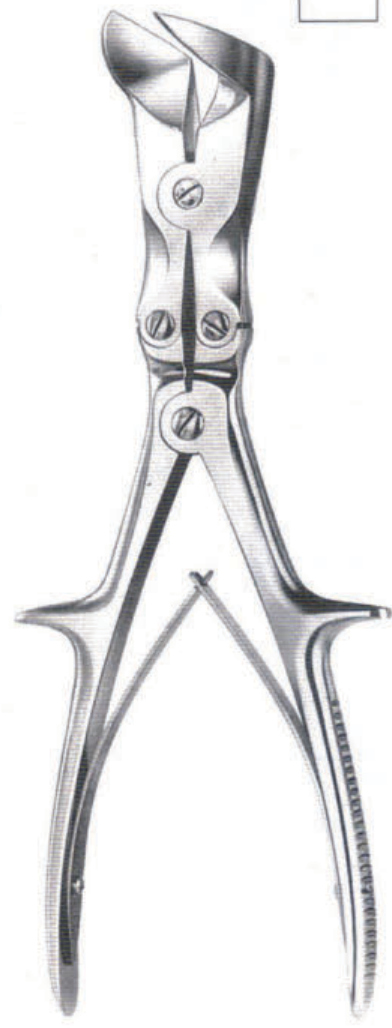

Stille Liston
Jo-21-967
27 cm, 10 1/2"



Jo-21-1132
wire twister / shear cutter
cuts wire up to 18g / twisted double



Jo-21-982
15 cm / 6"



Jo-21-984

Jo-21-985

17 cm / 6 3/4"

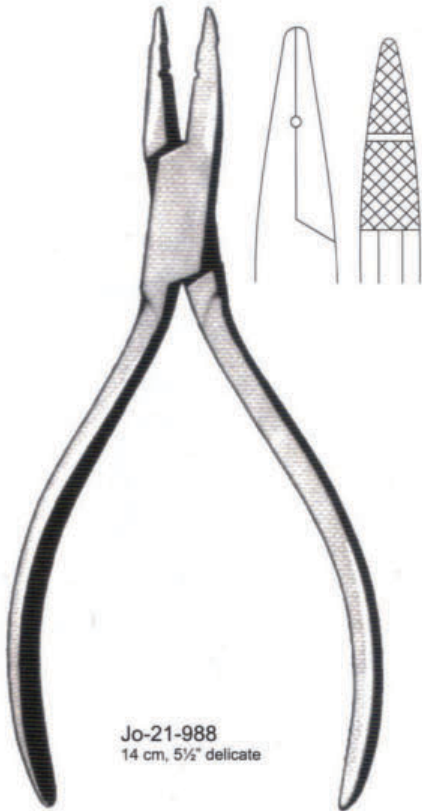

Jo-21-988
14 cm, 5 1/2" delicate



Flat Nose Pliers
Jo-21-989
14 cm, 5 1/2" broad

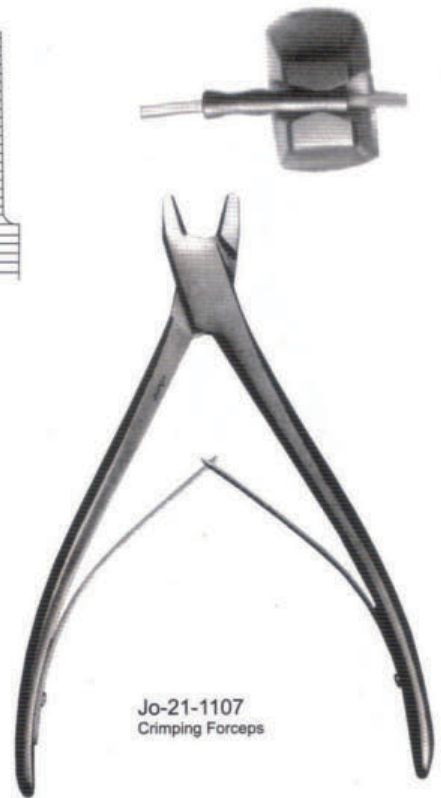

Jo-21-1107
Crimping Forceps



Jacobs Chuck
SV-2604-01 Small
SV-2604-02 Large
Stainless steel



SV-2605-00
Key for Jacobs Chuck
Stainless steel



Wire Tightner
SV-2603-00



Chuck
SV-2606-01 Small
SV-2606-02 Large
Chrome plated



SV-2607-00
Key for CP Chuck



Jo-21-1127
Small Cerclage
Wire Twister
18 cm, 7"
Anodized aluminum handle



Jo-21-1128
Large
Anodized aluminum handle



Jo-21-1129



Wire Twister
Jo-21-1130
Small
Stainless steel



Jo-21-1131
Large Cerclage
Wire Twister
18 cm, 7"
Anodized aluminum handle
stainless steel tip



Slip Joint Pliers
Jo-21-996
20 cm, 8"
10 mm tip maximum
opening 2"

		inside ∅	outsider ∅
Jo-21-997	Small	3 mm	5 mm
Jo-21-998	Medium	4 mm	6 mm
Jo-21-999	Large	6 mm	8 mm

Facilitates removal of wire and broken bone screws.



Michele Trephine



Jo-21-1135A ½" id
Jo-21-1135B ¾" id
Jo-21-1135C 1" id
"id" - inner diameter

Horsley's Trephine
10 cm 4"
stainless

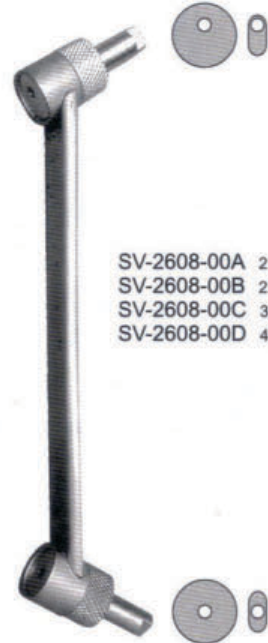

SV-2608-00A 2.0 mm
SV-2608-00B 2.7 mm
SV-2608-00C 3.5 mm
SV-2608-00D 4.5 mm

Drill Guide
SV-2608-00



Jo-21-1000
13 cm, 5¼"
Jo-21-1000A
17 cm, 6½"

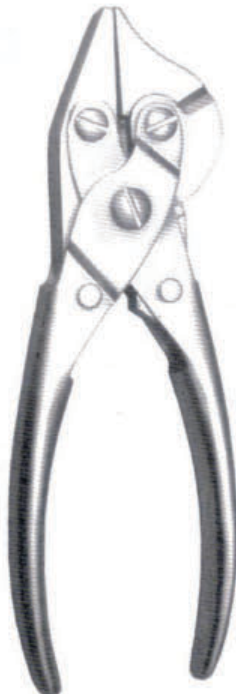

Jo-21-1000 B
17 cm
Jo-21-1000 C
12.5 cm
with side cutter



Jo-21-1001
18 cm, 7"



Surgicon Heavy Duty Locking Pliers & Needle Nose Locking Pliers with a new reinforced, more durable jaw. Heavy Duty jaws lock securely onto pins. Reinforced jaw hinge and jousing are more rigid to Help prevent side to side shifting. Made from 300 and 400 series surgical grade Stainless steel. Will not chip or contaminate other instrumentation. Adjustment screw for easy control of jaw opening. One. Handed, quick release self-locking lever. Available in three sizes.

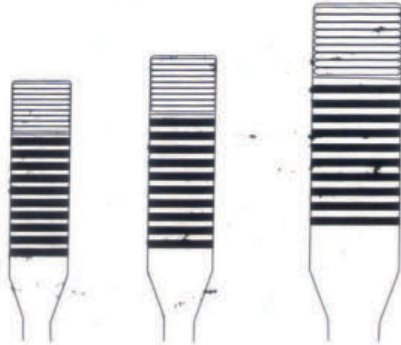

Small Locking pliers
Jo-21-1002
17.5 cm, 6 7/8"
tip width 7 mm
maximum opening 1"

Medium Locking Pliers
Jo-21-1003
20 cm, 8"
tip width 9 mm
maximum opening 1"

Large Locking Pliers
Jo-21-1004
25.5 cm, 10"
tip width 13 mm
maximum opening 1"

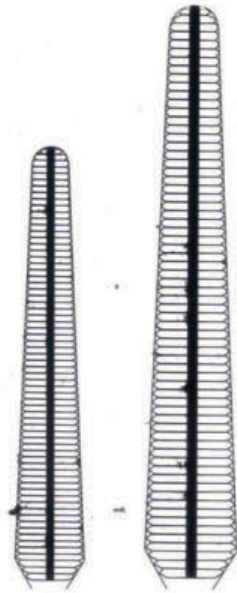

Large Needle Nose Locking Pliers
Jo-21-1006
30 cm, 12"
Length of jaw 3"
tip width 7 mm
jaws are parallel at 5 mm



Needle Nose Locking Pliers
Jo-21-1005
24 cm, 9 1/2"
length of jaw 2 1/2"
tip width 5 mm
jaws are parallel at 3 mm



JT-21-970
15 cm / 6"



JT-21-971
20 cm / 8"



JT-21-972 18 cm / 7"
JT-21-972 20 cm / 8"



JT-21-973
Holding forceps for cerclage wire with lateral jaws to avoid wire slipping off
17 cm / 6 3/4"



JT-21-974
Wire tightening pliers
Signature pliers
15 cm / 6"



Baumgartner
JT-21-975
Wire twister, Ligature forceps
20 cm / 8"



JT-21-976 **JT-21-977** **JT-21-978**

18 cm / 7"

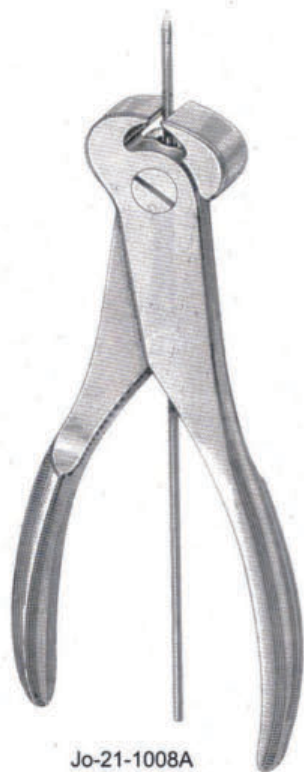

Jo-21-1008A

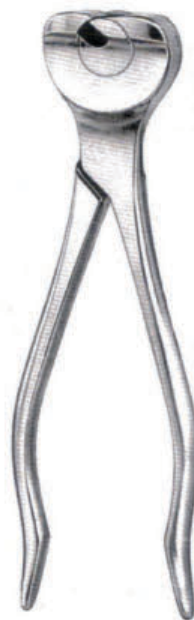

Jo-21-1008
16 cm, 6 1/4"



Jo-21-1018
47 cm, 18 1/2"
Cutter for Cutting off Kirschner Wires,
bolts, Tibia head screw,
Pins up to 6 mm diameter.



Cutter for Cutting off
Kirschner Wires,
Tibia head Screws, bolts & Pins
up to 4 mm diam.



New pattern with three holes
Cuts three wires at once
2 mm
3 mm
4 mm



Jo-21-1017
32 cm, 12 3/4"

for Soft Wire up to diameter	4.0 mm
for hard Wire up to diameter	4.0 mm



Jo-21-1017 C
32 cm, 12 3/4"
Cut three wires at once

for Soft Wire up to diameter	4.0 mm
for hard Wire up to diameter	4.0 mm

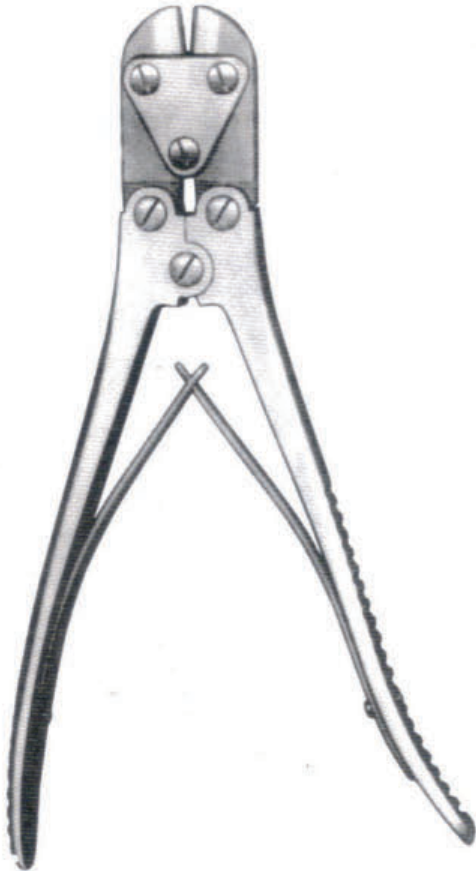
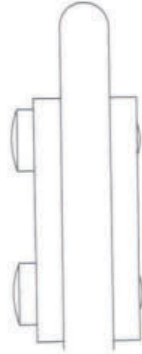

Plate Cutting Forcep
Jo-21-1019
24 cm, 9½"
for cutting stainless steel
mini plates up to 1 mm

- Also available in TC-Gold



Jo 21-1020
38 cm, 15"
Surgeon Double Action pin cutter,
Heavy Duty with Carb-N-Sert cutting
Blades, will cut up to ⅜"
Diameter, stainless



JT-21-1009
16 cm / 6 1/2"



JT-21-1010
22 cm / 8 3/4"



JT-21-1011



JT-21-1016
22 cm / 8 3/4"



JT-21-1012
15 cm / 6"



JT-21-1014
18 cm / 7"



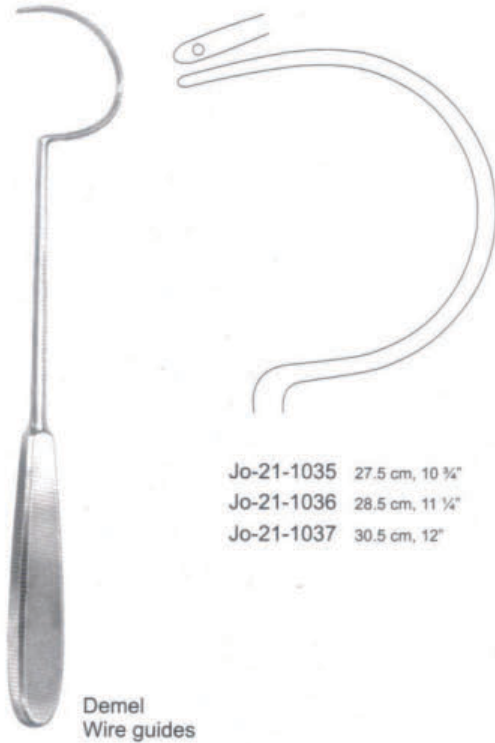

Jo-21-1035 27.5 cm, 10 3/4"
 Jo-21-1036 28.5 cm, 11 1/4"
 Jo-21-1037 30.5 cm, 12"

Demel
Wire guides

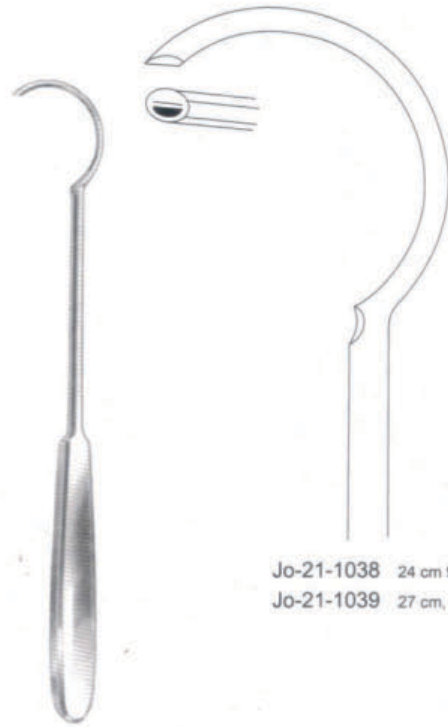

Jo-21-1038 24 cm 9 1/2"
 Jo-21-1039 27 cm, 10 3/4"

All sizes could be made according to custom specification



Jo-21-1040
22.5 cm, 9"

Jo-21-1116 XS X-Small curved graft passer
 Jo-21-1117 S Small curved graft passer
 Jo-21-1118 Large curved graft passer
 Jo-21-1119 L X-Large curved graft passer
 Jo-21-1120 XL XX-Large curved graft passer



Slot cut into head

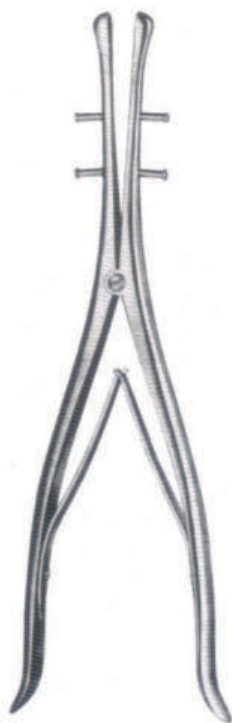
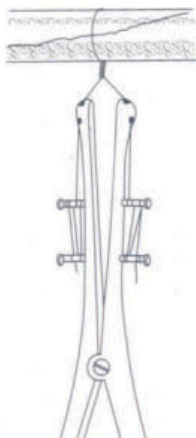

Demel
Jo-21-1041
28 cm / 11"



Loute
Jo-21-1042
21 cm / 8 1/4"



Jo-21-1105
Cerclage wire passer

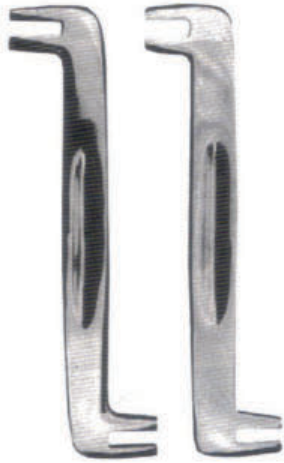

Jo-21-1124
Plate Benders

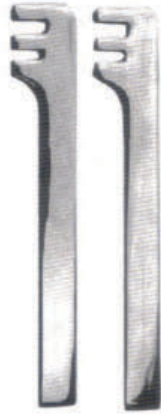

Jo-21-1125
Plate Benders



Jo-21-1126
Plate Benders

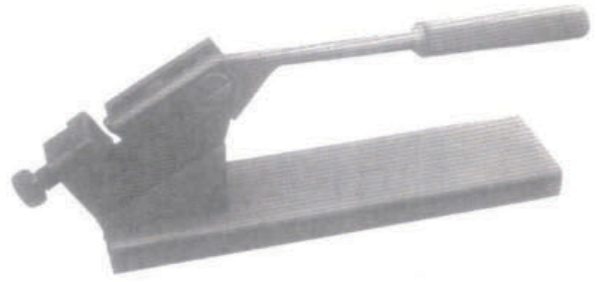

Jo-21-1138
Large Bone Plate Press



Jo-21-1122
Plate Bending Plier



Jo-21-1123
Plate Bending Plier



Front Leg		Hind Leg	
Jo-21-1109	Small	Jo-21-1112	X-small
Jo-21-1110	Medium	Jo-21-1113	Small
Jo-21-1111	Large	Jo-21-1114	Medium
		Jo-21-1115	Large

Eye Instruments



Barraquer
J-50-4000 Small
J-50-4000L Large



Graefe
J-50-040 7 cm / 2¾"
J-50-050 9 cm / 3½"



Knapp - Clark
J-50-030
8 cm / 3¼"



Castroviejo
SV-1332-08
8 cm



Millinger
SV-1333-07
7 cm



Lister / Burch
J-50-120
8 cm / 3¼"

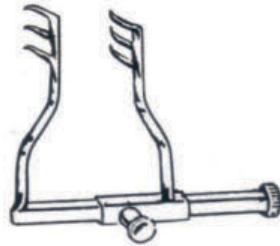

Goldstein
SV-1339-00



Desmarres
13 cm / 5"



J-50-150
12 mm



J-50-160
14 mm



J-50-170
16 mm



J-50-180
18 mm



Mueller
J-50-130
7 cm / 2¾"



Stevenson
J-50-140
7 cm / 2¾"

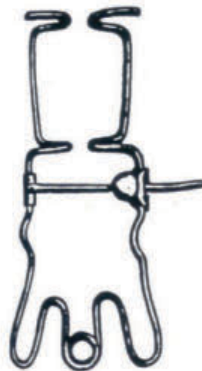

SV-1342-13
13 cm
For large animals



Bowman
 J-50-421 0.8 mm
 J-50-430 0.9 mm
 J-50-440 1.1 mm
 J-50-450 1.3 mm
 J-50-460 1.4 mm
 J-50-470 1.5 mm
 J-50-480 1.6 mm
 J-50-490 1.8 mm



J-50-520



J-50-530
 Wilder
 Nettleship



J-50-540



Gkuht
 J-50-4002



Gkuht
 J-50-4003



J-50-4004



Kuhnt
 J-50-4005



Meyhoefer
 J-50-1550 0.5 mm
 J-50-1630 4.5 mm



Castroviejo
 J-50-1930



J-50-4006



Weber
 J-50-1300
 J-50-1310



Desmarres
J-50-2760
9 cm / 3½"



J-50-4007



Knapp
J-50-2810
11 cm / 4½"



Graefe
J-50-2620
11 cm / 4½"



Graefe
J-50-2630
11 cm / 4½"



J-50-4008



J-50-4012



Hess
J-50-2520
6 cm / 2½"



J-50-4009



J-50-4010



J-50-4011



Arruga
J-50-2590
9.5 cm / 3½"



Graefe

7 cm / 2 1/4"
10 cm / 4"



J-50-2030
J-50-2040



J-50-2050
J-50-2060



J-50-2070
J-50-2080



J-50-2090
J-50-2100



J-50-2110
J-50-2120



J-50-2130
J-50-2140



Bishop Harman
J-50-2370
8.5 cm / 3 1/2"
Fine



Gill-Hess
J-50-2510
7.5 cm / 3"



Hess
J-50-2420
7 cm / 2 1/4"



Fuchs
J-50-2540
7 cm / 2 1/4"



Noyes
12 cm / 4 3/4"
Straight

Straight J-50-2860
Angled J-50-2890
sharp / sharp



J-50-2870
J-50-2900
sharp / blunt



J-50-2880
J-50-2910
blunt / blunt



Noyes
12 cm / 4 3/4"
Angled



Castroviejo
J-50-2920
9 cm / 3 1/2"



Westcott
J-50-2950
11 cm / 4 1/2"



Castroviejo
13 cm / 5 1/4"
with lock



Barraquer
J-24-075 with lock
J-24-076 without lock
13 cm / 5 1/4"



Arruga
16 cm / 6 1/4"



Castration

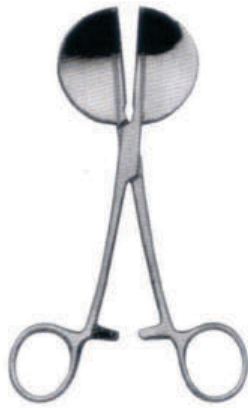

Bolbecker Forceps
SV-1802-16
16 cm



Castrating Knife
USA. Model
Newberry
SV-1182-00



Elastrator Putor
SV-1186-22
22 cm



Elastrator
SV-1186-22 S
24 cm
Stainless steel

Spaying & Castrating Hooks



Covault
SV-1187-20
20 Cm
Probepoint

For Cats

Snook
SV-1188-20
20 Cm
Flat

Castrating Knives & Bistouries



Double Folding
Fig.1,3 SV-1194-00
Fig.2,3 SV-1195-00
Hook & scalpel

Single Folding
Fig.1 SV-1191-00 Hook Blade
Fig.2 SV-1192-00 Hole Blade
Fig.3 SV-1193-00 Scalpel



SV-1189-11
11 cm



Abscess Knife

Syme
SV-0097-16
16 cm
Solid Forged



Cooper
SV-0098-16
16.5 cm
for hernia
Solid Forged



SV-1800-13
Solid Forged



SV-1190-00



Serrated

Spay
SV-1203-30
30 cm
SV-1204-40
40 cm
for flank
curved



SV-1205-14
14 cm



Noel
SV-1206-14
14 cm



Fabritius
SV-1207-19
19 cm

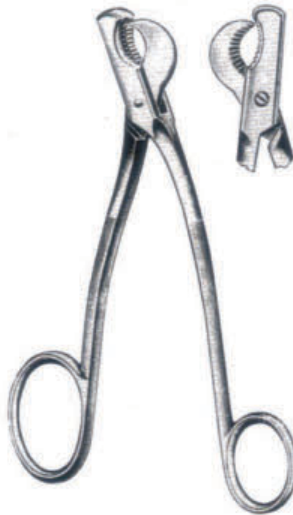

Munchen Model
SV-1209-19
19 cm

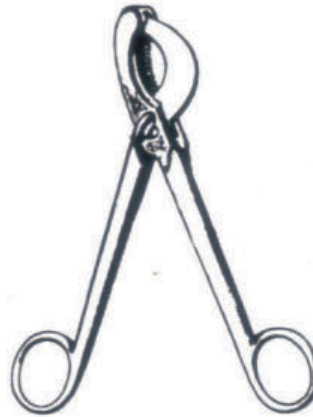

SV-1210-15
15 cm



Frank
SV-1211-22
22 cm



Hausmann
SV-1212-19
19 cm
SV-1213-23
23 cm
Straight Handle



Hausmann
SV-1214-19 19 cm
SV-1215-23 23 cm
SV-1216-27 27 cm
SV-1217-31 31 cm
SV-1218-36 36 cm
SV-1219-48 48 cm



SV-1226-19
19 cm
With Tube



Verboczy
SV-1220-27
27 cm
With Double Crush

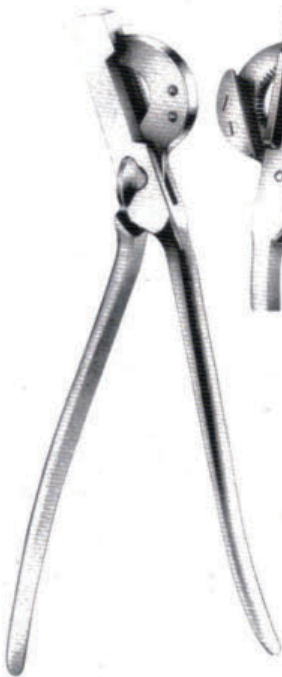

Hausmann / White
SV-1223-19 19 cm
SV-1224-31 31 cm



Bertschy
SV-1221-38
38 cm

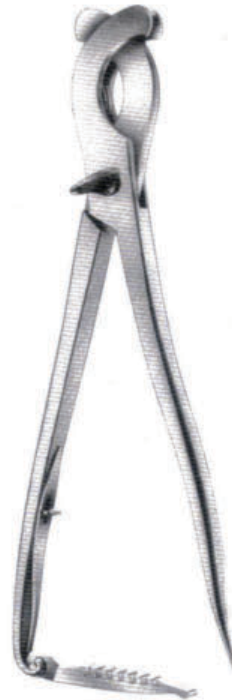

Sand
SV-1222-31
31 cm
Curved sand emasculator
is also available SV-1222-31 C



Reimer
SV-1225-31
31 cm

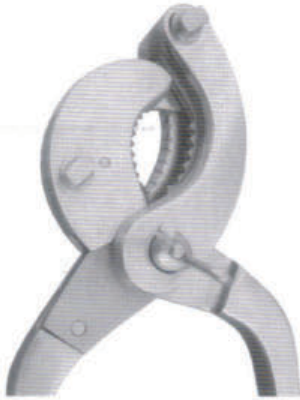

Serra
Modified
SV-1227-35
35 cm
Non Slip grip & positive crush
For one hand use



Serra
SV-1227-35 R
35 cm
Modified, with ratchet

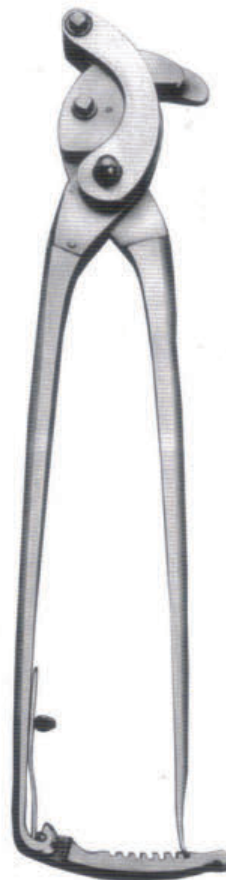

Serra
SV-1227-35 S
35 cm straight
with ratchet



Bloodless Castrators
With Card Stop
SV-1228-23
23 cm



SV-1229-30 30 cm
SV-1230-35 35 cm
For Lambs, Rams, Pigs, Dogs, Colts
SV-1231-40 40 cm
SV-1232-48 48 cm
For Bulls, Camels, and Buffalos



Ecrasseur
SV-1183-55
55 cm, straight

Small Animal



Rodent Mouth Gag
SV-0049-00



Rodent Mouth Gag.
SV-0049-00H
Heavy pattern



Rodent Mouth Gag
SV-0049-00S
Small



Rabbit Mouth Gag
SV-0049-00R
Retractor type



Cheek Spreader
SV-0050-00
Small



Cheek Spreader
SV-0051-00
Large



Cheek Spreader
SV-0051-00A



Cheek Spreader
SV-0051-00B

● Cheek spreaders are also available in different sizes on request



SV-2231-00
Molar Extraction Forcep .

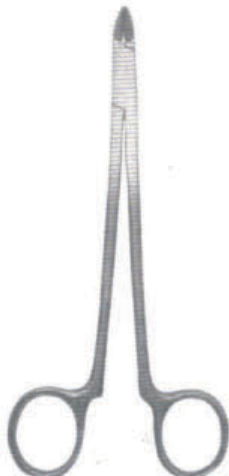

SV-2232-00
Molar Cutter.

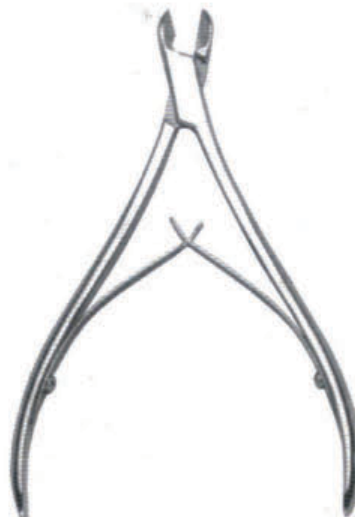

SV-2229-00
Molar Cutter.
TC



SV-2230-00
Molar Cutter.



Spatula
SV-1901-00

Hallman
SV-1902-00
Spatula small

Hallman
SV-1903-00
Spatula large



SV-2225-00

SV-2226-00
Molar Rasp

SV-2227-00

Molar Rasp

Molar Rasp
SV-2228-00
TC

• Cats & dog mouth gags are also available in different patterns on request.



GRAY (for cats and dogs)
SV-0046-09 9 cm xsmall
SV-0046-11 11 cm small
SV-0047-14 14 cm medium
SV-0048-18 18 cm large

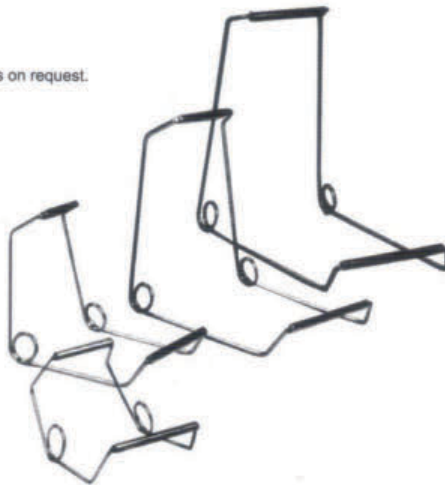

Smith Baxter
SV-2560-00 set of five
SV-2560-A xsmall
SV-2560-B small
SV-2560-C medium
SV-2560-D large
SV-2560-E xlarge



Fergusson
SV-0040-16 16 cm
SV-0041-20 20 cm

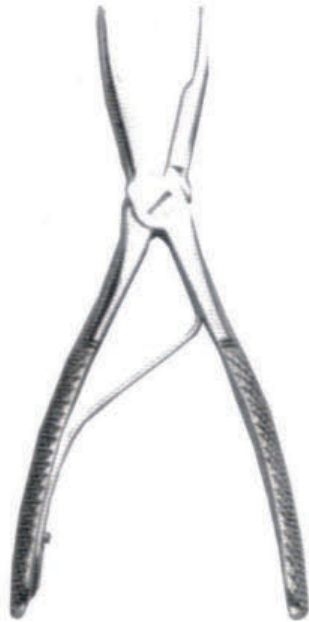

SV-2245-00

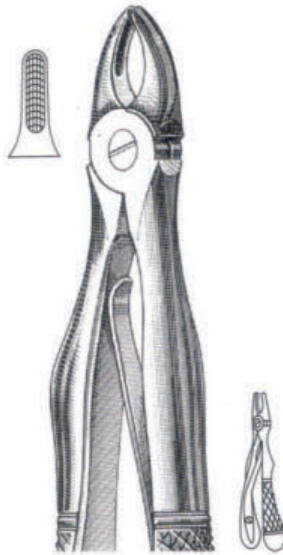

Klein
SD-0299-137
Fig. 137
for upper incisors and canines

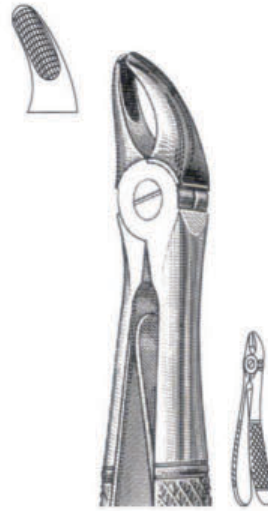

Klein
SD-0300-139
Fig. 139
for upper bicuspids

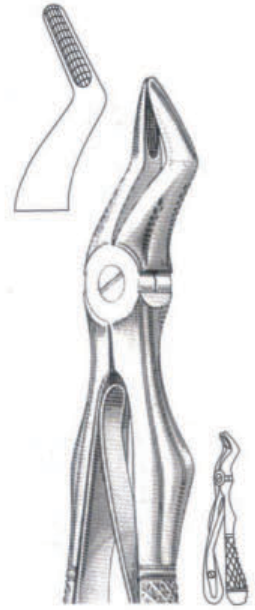

Klein
SD-0298-51S
Fig. 51S
for upper roots

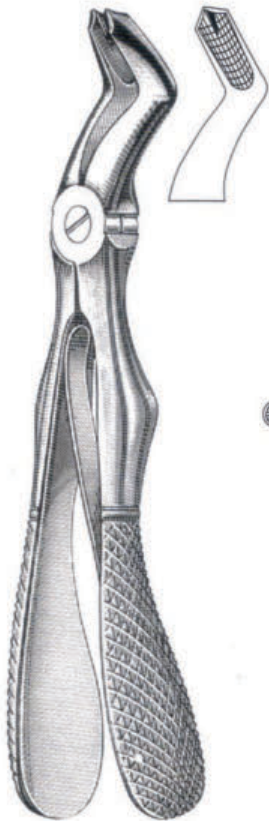

Klein
SD-0294-03
Fig. 3
for upper molars

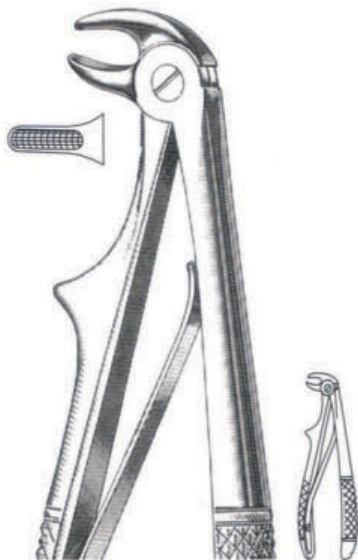

Klein
SD-0295-05
Fig. 5
For lower incisors

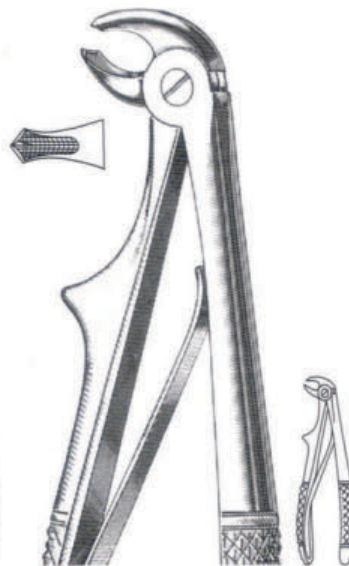

Klein
SD-0296-06
Fig. 6
for lower molars

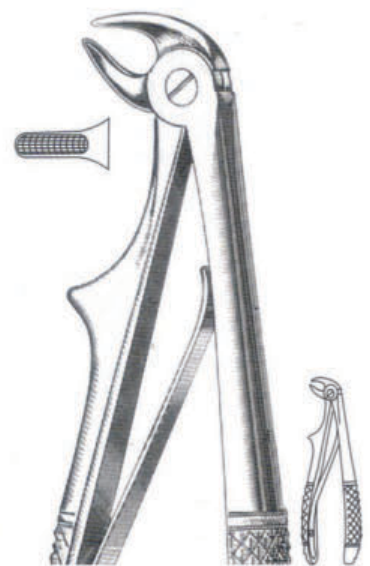

Klein
SD-0297-07
Fig. 7
for lower roots



Witzel
SD-0307-501
Fig. 501
Universal Pattern for upper teeth

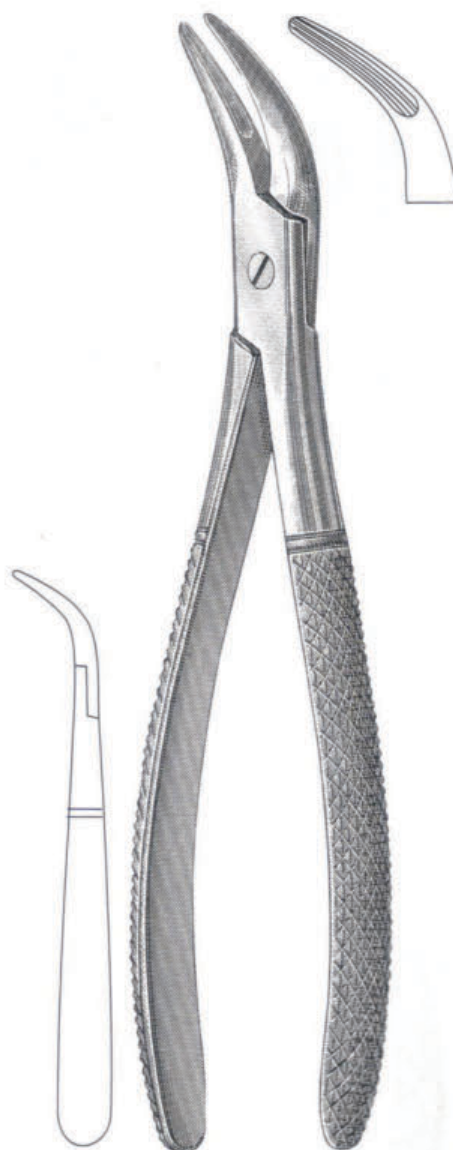

Witzel
SD-0308-502
Fig. 502
Universal Pattern for lower teeth



SV-2235-00
7"



SV-2236-00
7"



SV-2237-00
7"



SV-2238-00
7"



Maller Feliner
SV-2234-00
4 1/2"
Dental Extractor, Stainless.



Mirror Dental
with handle



- J-34-1026 Fig. 00 = 8 mm Ø
- J-34-1027 Fig. 0 = 10 mm Ø
- J-34-1028 Fig. 1 = 12 mm Ø
- J-34-1029 Fig. 2 = 14 mm Ø
- J-34-1030 Fig. 3 = 16 mm Ø
- J-34-1031 Fig. 4 = 18 mm Ø
- J-34-1032 Fig. 5 = 20 mm Ø
- J-34-1033 Fig. 6 = 22 mm Ø
- J-34-1034 Fig. 7 = 24 mm Ø
- J-34-1035 Fig. 8 = 26 mm Ø
- J-34-1036 Fig. 9 = 28 mm Ø
- J-34-1037 Fig. 10 = 30 mm Ø



SV-2211-00
Dental Explorer
Measuring Probe.
6 1/2".



Jo-21-1106
Meniscus knife



SV-2200-00
Canine Tartar
Scraper
Stainless Steel, 5 1/4"



SV-1468-00
Canine Tartar
Scraper
Stainless Steel, 6 1/4"



SV-2201-00
Double-Ended
Scraper
Stainless - 6"



SV-2202-00
Dental Scaler. #6
Stainless - 6" L



SV-2203-00
Subgingival Curette
Double ended
Stainless - 6"



SV-2204-00
Crossley Rabbit
Incisor Luxator.



SV-2205-00
Crossley Molar
Luxator.



Scalor
SV-1478-00A



Scalor
SV-1478-00



Scalor
SV-1480-00



Scalor
SV-1457-00



Jacquette Scaler
SV-2561-00
2.3 ss
Double end



Jacquette Scaler
SV-2562-00
6.7 ss
Double end.



Columbia Curette
SV-2563-00
C2L / C2R
Double end.



McCalls Curette
SV-2564-00
11.12



Bein
SD-0741-01
Fig. 1



Bein
SD-0741-02
Fig. 2



Bein
SD-0741-03
Fig. 3



Bein
SD-0741-04
Fig. 4



Bein
SD-0741-05
Fig. 5



Bein
SD-0741-06
Fig. 6

Perio Elevator



SV-2215-00



Perio
SV-2250-00



Perio
SV-2251-00



SV-2252-00
Elevators



SV-2253-00
Elevators



SV-2216-00
Small.
2 mm. 5/4"

SV-2217-00
Medium.
3 mm. 5/4"

SV-2218-00
Large.
4 mm. 5/4"



SV-2219-00
Small.



SV-2220-00
Medium.



SV-2221-00
Large.



SV-2222-00
Small.



SV-2223-00
Medium.



SV-2224-00
Large.



Standard Cartridge Syringe
SV-2609-00
2.20 ml



Popular Dual Self Asp. Syringe
SV-2610-00
2.0 ml



Classical ASP. Syringe
SV-2611-00
1.80 ml

Large Animal

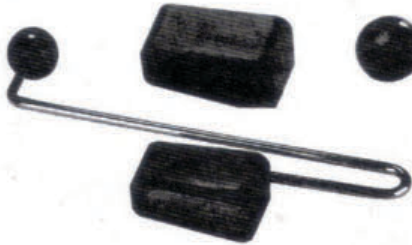

SV-0027-00A

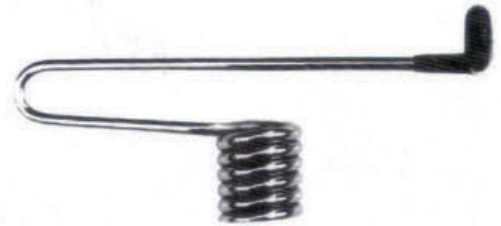
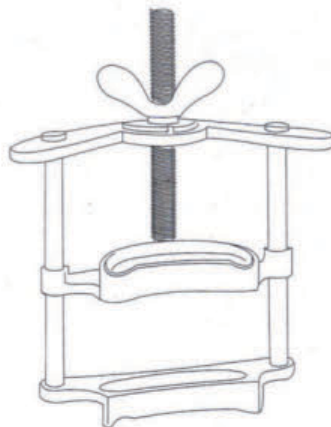

SV-0027-00B

Schoope
SV-0027-00Gunther
SV-0024-00
Mouth Gage for HorsesButler
SV-0024-00A
Mouth Gags for HorsesBayer
SV-0043-00
Mouth wedges C.P.



Mouth Gag
SV-1880-00
Swedish Pattern
with leather straps



Hausmann / Climax
SV-0029-00
with leather straps
stainless steel forged



Hitching
SV-0025-00

SV-0025-LC
with leather cover

SV-0025-PC
with plastic cover



Varnell Mouth Gag
SV-0026-00

SV-0026-LC
with leather cover

SV-0026-PC
with plastic cover

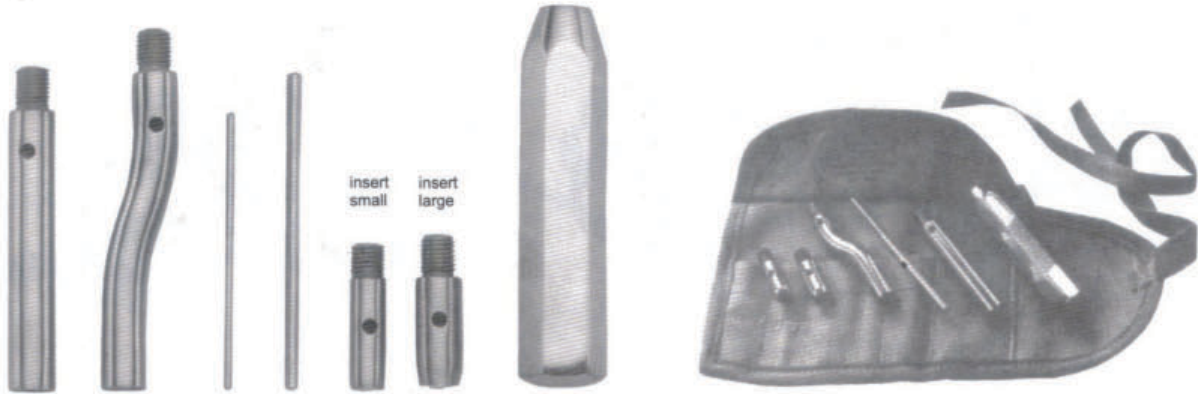

Non Slip Wolf Tooth Elevator Set
 Wolf Tooth Elevator set is also available with Fiber Handle

SV-1930-00
 Wolf Tooth Extractor set
SV-1930-00 F
 with Fiber Handle



SV-1506-00



SV-1935-18 18"
SV-1936-24 24"

SV-1937-18 18"
SV-1938-24 24"

SV-1939-18 18"
SV-1940-24 24"

SV-1502-37 37 cm
SV-1503-47 47 cm
SV-1504-50 50 cm

Tooth Rasps are also available in all sizes and shapes on request



SV-1931-00
Deluxe Wolf Tooth Extractor set



SV-1926-00
Thumb Speculum



Wolf Tooth Extractor
SV-2612-00
with key
8 mm id 14 mm od
10 mm id 16 mm od
"id" inner diameter
"od" outer diameter

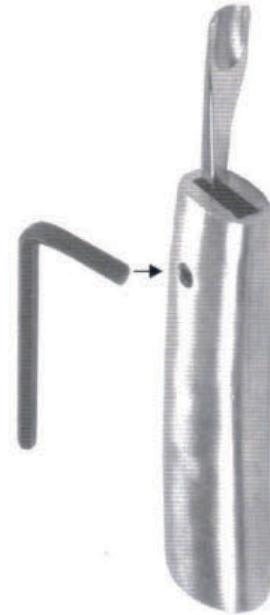

SV-1485-00



Dental Tooth Punch
SV-2613-00 with Serrated Heads
SV-2614-00



SV-1927-00
Straight



SV-1928-00
curved



SV-1932-00
Deluxe wolf
tooth elevator



SV-1933-00
Dental Chisel



SV-1934-00
Dental chisel



SV-2000-00



SV-2001-00

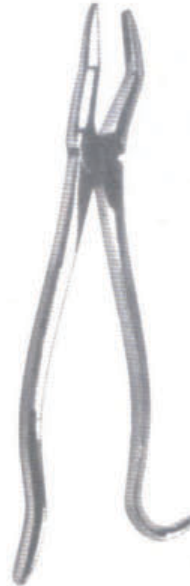

SV-2002-00



SV-2005-00
Deciduous Incisor tooth
extraction Forceps



SV-2006-00
Deciduous premolar
cap extraction forceps



SV-2007-00
Universal small tooth
extraction forceps



SV-2008-00
Cheek tooth extractor



Reylond Tooth Forceps
SV-2003-00A Upper jaw
SV-2003-00B Lower jaw
Serrated jaw



SV-2004-00
Apple jaw



SV-1407-63
63 cm

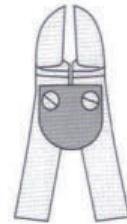

SV-1408-63
63 cm

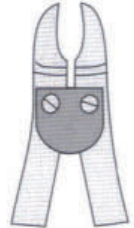

SV-1409-63
63 cm



Equine Dental Forcep
SV-2615-00



Equine Dental Forcep
SV-2616-00



Equine Dental Forceps
SV-2009-00
20" Large
SV-2009-00S
12" Small



Gunther
SV-1410-43
43 cm
SV-1411-50
50 cm



Compound Molar Cutter
with detachable handles for easy storage
tooth cutter for horse



Uterine Biopsy Forcep
SV-2566-60B
with basket
SV-2566-60
without basket

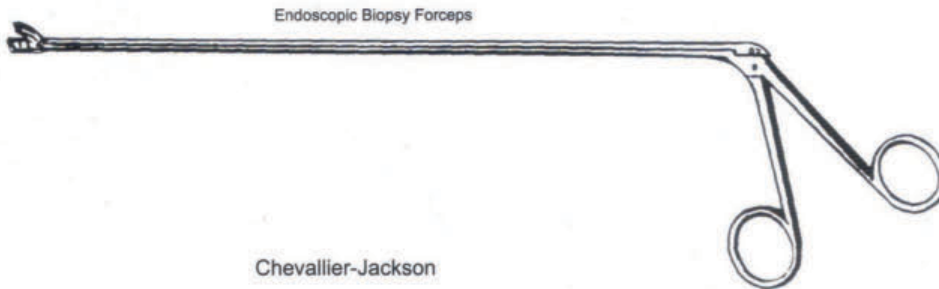

Endoscopic Biopsy Forceps

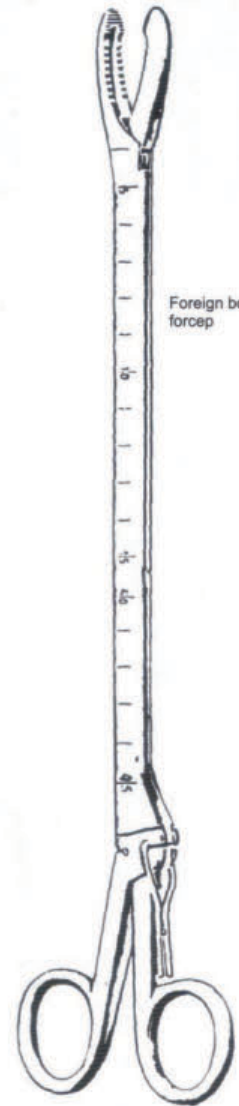

Foreign body
forcep

Chevallier-Jackson



- SV-1109-28 28 cm
- SV-1110-35 35 cm
- SV-1111-17 17 cm
- SV-1112-50 50 cm



- SV-1113-28 28 cm
- SV-1114-35 35 cm
- SV-1115-17 17 cm
- SV-1116-50 50 cm



- SV-1117-28 28 cm
- SV-1118-35 35 cm
- SV-1119-17 17 cm
- SV-1120-50 50 cm



- SV-1121-28 28 cm
- SV-1122-35 35 cm
- SV-1123-17 17 cm
- SV-1124-50 50 cm

- SV-1129-30 30 cm
- SV-1130-45 45 cm

Miscellaneous



SV-0014-11
11 cm
Crome Plated
SV-0014-11 P
Putor



Harm
SV-0013-18
18 cm
Stainless Steel



SV-0012-22
22 cm
crome plated with chain
SV-0012-22 S
stainless steel



SV-0012-22A
22 cm
crome plated without chain
SV-0012-22 B
stainless steel

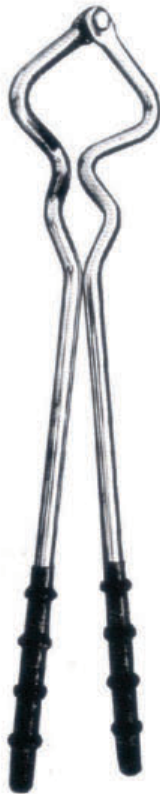

Continental
SV-0010-43
43 cm

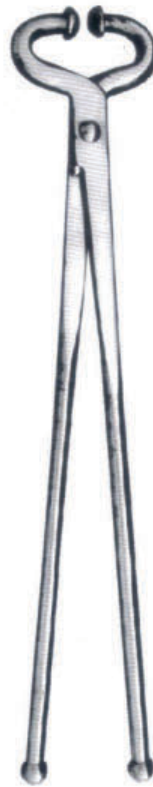

SV-0011-53
53 cm
crome plated
SC-0011-53 S
stainless steel



Kendall
SV-0015-35
35 mm



Trops
SV-0015-58
Rope 58 cm



SV-0015-58A



SV-0015-58B



Nuesch
SV-0016-24
24 cm shaft
Schoettle
SV-0017-60
60 cm shaft



SV-0018-64
64 cm
Metal



Cats & Dogs Catcher
SV-0019-15
152 cm



Calf Snare (Cable type).
SV-2513-26
26"
Useful in difficult calvings for pulling
a retracted head for ward or from
preventing the head from turning
back during delivery.



SV-2512-00
Swine Cable OB Snare,

T-bar Sow OB Snare
SV-2511-10
10"

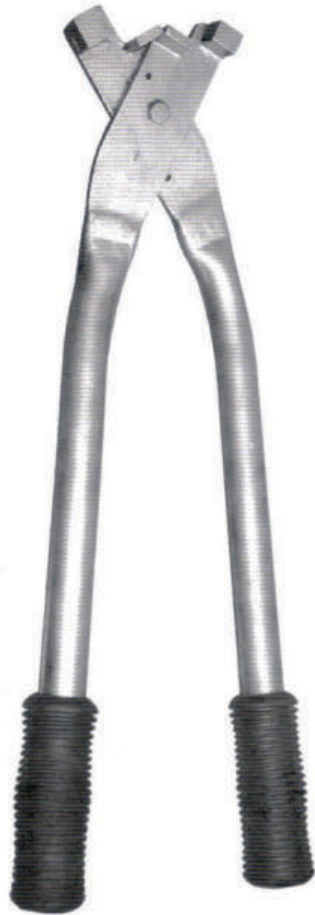

SV-2514-00



SV-1271.00



SV-1272.00



SV-1273.00

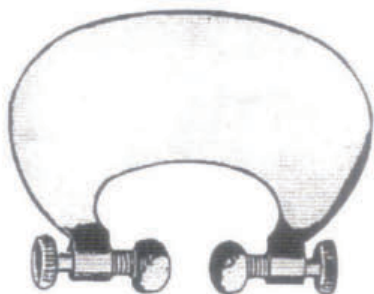

Wilson
Size1 SV-1275-00
Size2 SV-1276-00
Size3 SV-1277-00
Size4 SV-1278-00
Milk sucking Preventor (Aluminum)

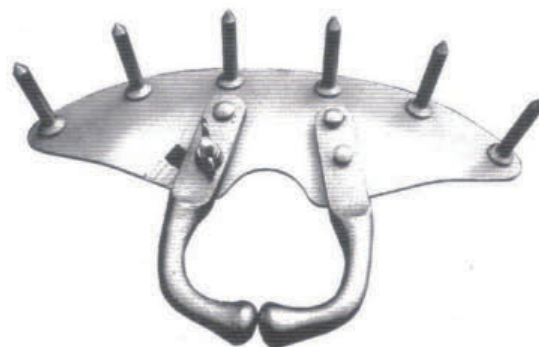

SV-1279-00



SV-0030-00
52 mm Dia
For Pig



SV-0031-00
58 mm Dia
For Pig



SV-0032-00
65 mm Dia
For Pig

Anillo Nasal Rings
Nose ring for pigs (Copper)



SV-0033-38
38 cm dia

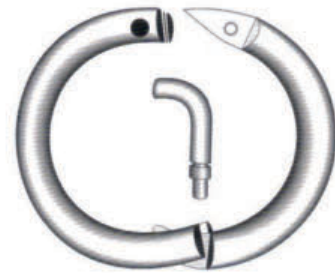

SV-0034-65 (65 cm dia)
SV-0035-70 (70 cm dia)
SV-0036-80 (80 cm dia)
For Bulls



SV-0038-26
26 cm



SV-0037-26
26 cm



Frank
SV-0039-26
26 cm
Nose Punch

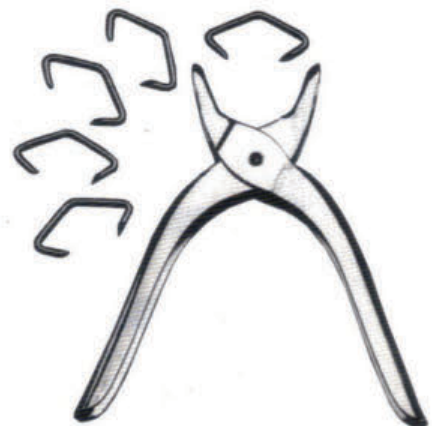

SV-2567-17
17 cm
Clip Applying Forceps
Wound clips for skin closures on cattle



Schulze
SV-0042-00
for Horses & Cattle



SV-0044-00
for cattle



Drinkwater
SV-0052-00 Left
SV-0053-00 Right
Aluminum made

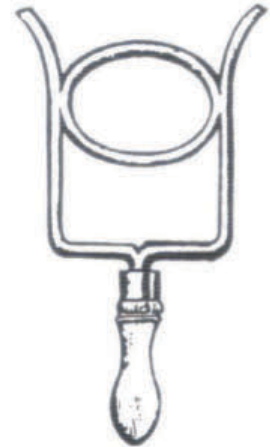

SV-0054-00
for Pigs



Mouth Gag
SV-0055-00

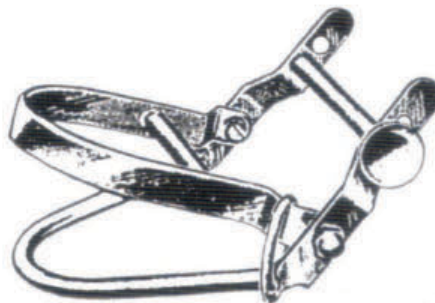

Weingart
SV-0056-00



SV-1274-00



Grave
SV-0999-00 Small
SV-1000-00 Medium
SV-1001-00 Large



Russian
SV-1002-16
16 cm
Blades 10 cm

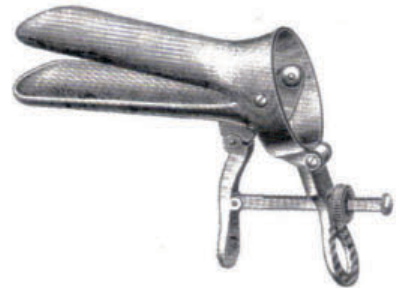

Cusco
V. SV-1003-00
S. SV-1004-00
M. SV-1005-00
L. SV-1006-00
M.L. SV-1007-00

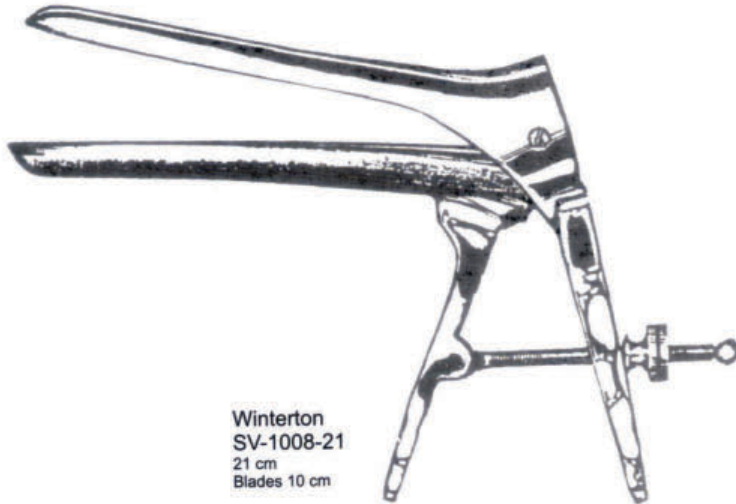

Winterton
SV-1008-21
21 cm
Blades 10 cm



Russian
SV-1009-00
SV-1010-00
Blades 10 cm

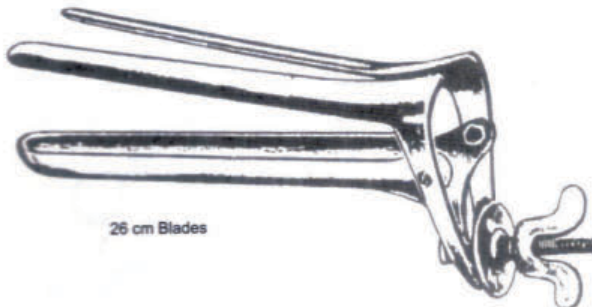

26 cm Blades

Polansky
SV-1011-00
27 cm
Blades 3.5 cm
For Cow

Weingart's Stomach Operating Set
for removing foreign bodies from the rumen

SV-0952-00

Set containing
2. Valsellum forceps
1. Fixation frame
8. fixation teneculums

SV-0953-00
SV-0954-00
SV-0955-00



SV-0956-24
24 cm



SV-0957-08
8 cm



SV-0958-28
28 cm



SV-0959-20
with hook
20 cm

SV-0960-20
without hook
20 cm



Bovina Cervical
SV-2568-54
54 cm



Ostertag
SV-1012-65
6.5 cm



Harm
SV-1013-08 8 cm
SV-1014-10 10 cm



Harm
SV-1015-00
SV-1016-00



Freyberger
SV-1017-55
5.5 cm



SV-1018-00



Vogel
SV-1019-11
11 cm



Vienna
SV-1020-14
14 cm



Ruggeberg
SV-1022-14
14 cm
Spring Action



Krey-Schottler
SV-1023-21
21 cm



Krey-Schottler Heavy
SV-1023-21H
21 cm
SV-1023-21T
1 x 2 teeth

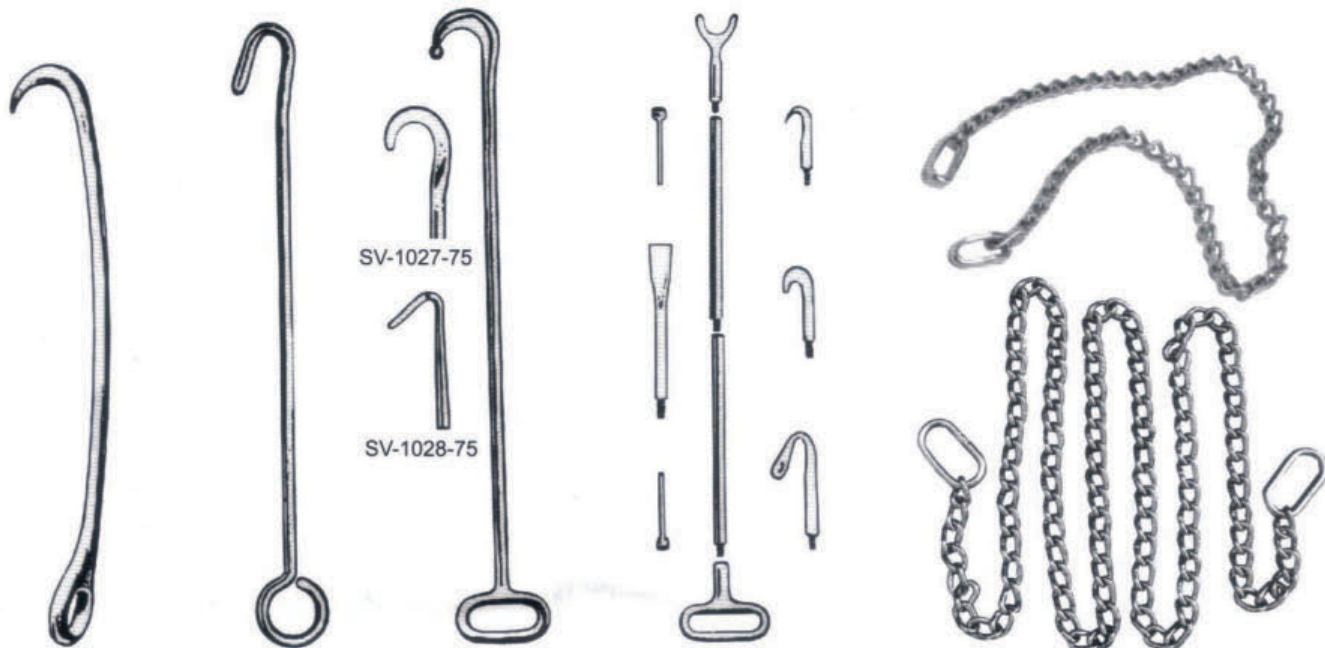

Obermayer
SV-1024-30
30 cm

Harm
SV-1025-50
50 cm

SV-1027-75

SV-1028-75

William
SV-1026-75
75 cm

SV-1029-10
100 cm
Set of 10 pieces

Moore (OB. Chain)
SV-1030-26 26 cm
SV-1031-53 53 cm
SV-1032-75 75 cm
SV-1033-15 150 cm
SV-1034-19 190 cm



SV-1035-00
O.B. Chain Handle



O. B. Chain Handle
SV-1035-00A



SV-1037-00
O,B chain Handle



Keller
SV-1038-75
75 cm



Caemmerer
SV-1039-78
78 cm
Torsion Fork



Benesch / Kuhn
SV-1040-84
84 cm
Crutch



SV-1041-00
Detorsion rod



SV-1042-00
Wire and rope carrier



Sand
SV-1044-19
19 cm
Light Model
Wire and rope carrier



Sand
SV-1043-19
19 cm
Wire and rope carrier

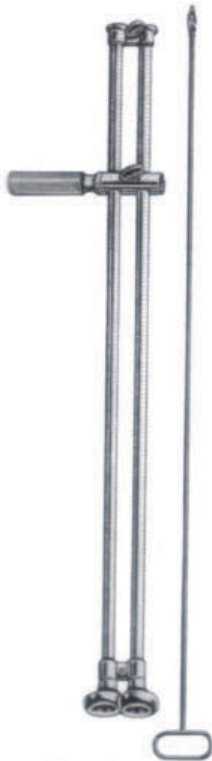

SV-1045-71
71 cm
Embryotome tube (complete)



SV-2509-00
33"
Thygesen's Fetatome. Two-tube model With adjustable handle for OB Chain. This is the breakdown model, complete with insertion coil and cleaning brush. 33"L.

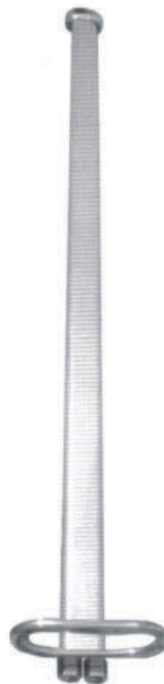

Utrecht Feta-Tome
SV-2617-38
38" L, Light Weight



SV-1046-86
86 cm



Schriever
SV-1036-00
Rope introducer



SV-1049-00



Swedish Model
SV-1050-00



Thompson
SV-1052-00

Finger Knife



Linde Knife
SV-1054-10
10 cm



Sutter
SV-1047-00
Embryotome
saw handle



SV-1048-00
Wire handle



Lyes
SV-1051-00
Handle



Hobday
SV-1059-24
30 cm
Uterine Holding



Albrechtsen
SV-1061-20
30 cm



Hobday
SV-1062-14
14 cm



Danish Model
SV-1063-20
20 cm

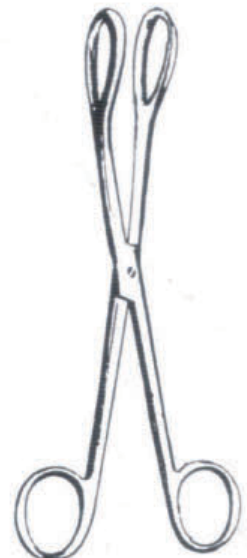

Hobday
SV-1064-21
21 cm

Finger Knife



SV-1053-65
6.5 cm
Embryotomy Knife



McLean
SV-1065-20
20 cm
SV-1066-25
25 cm
SV-1067-30
30 cm



Danish Model
SV-1070-23
23 cm, for bitches
SV-1071-60
60 cm, for sheeps



SV-1073-30
35 cm



Witt / Gehrt
SV-1074-52
52 cm



SV-1076-30
30 cm
Uterine Holding



SV-1218-00
Anti cow kick



Witte
SV-1568-00
31 cm



O.B Chain with Handle
SV-1035-00C



Calf Puller
SV-2510-00

Blood Taking Needles



SV-1569-09
9 cm



Sudan Patt.
SV-1570-09
9 cm



Hannover
SV-1571-06 = 6 cm
SV-1572-08 = 8 cm
SV-1573-10 = 10 cm

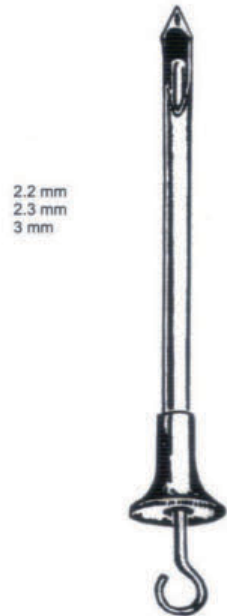

2.2 mm
2.3 mm
3 mm

Troester
SV-1574-08
8 cm



Buhner
SV-1132-18A 18 cm
SV-1132-23A 23 cm
SV-1132-30 30 cm



Gerlach / Buhner
SV-1132-18 18 cm
SV-1132-23 23 cm
SV-1132-24 24 cm



SV-1135-11
11 cm
Vulva Suture Pin
Needle only.



Plastic Balls
SV-1137-00

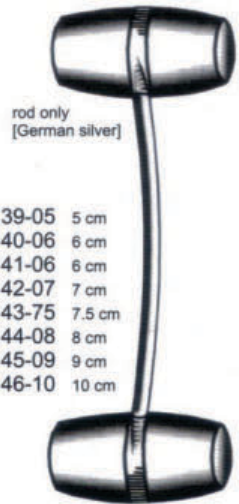

rod only
[German silver]
SV-1139-05 5 cm
SV-1140-06 6 cm
SV-1141-06 6 cm
SV-1142-07 7 cm
SV-1143-75 7.5 cm
SV-1144-08 8 cm
SV-1145-09 9 cm
SV-1146-10 10 cm

Plastic stoppers
SV-1138-00



for sheep

Shaft 9 cm
 SV-0963-00 4 mm Ø
 SV-0964-00 5 mm Ø
 SV-0965-00 6 mm Ø

Shaft 15 cm
 SV-0966-00 8 mm Ø
 SV-0967-00 9 mm Ø



SV-0968-00 10 cm X 4 mm Ø
 SV-0969-00 11 cm X 5 mm Ø
 SV-0970-00 12 cm X 3 mm Ø
 SV-0971-00 13 cm X 7 mm Ø
 SV-0972-00 18 cm X 7 mm Ø
 SV-0973-00 28 cm X 5 mm Ø



Oval shape
 1. 6 X 3 mm Ø
 2. 9 X 7 mm Ø
 3. 12 X 7 mm Ø
 4. 15 X 10 mm Ø

for sheep and cattle

1. SV-0976-09 9 cm
 2. SV-0977-16 16 cm
 3. SV-0978-16 16 cm
 4. SV-0979-16 16 cm



SV-0980-09 9 cm X 5 mm Ø
 SV-0981-12 12 cm X 12 mm Ø
 SV-0982-15 15 cm X 15 mm Ø
 with one spare cannula

Also available with wooden handle

Sharp point prob PC

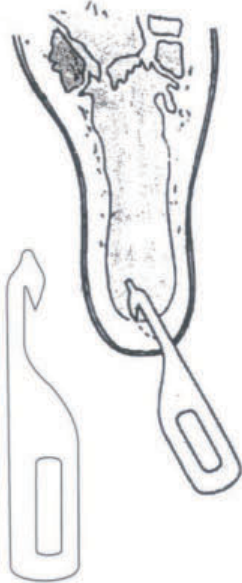

Dyakjaer
SV-1233-00



Lichy
SV-1234-00
12 cm



Hug
SV-1235-15
15 cm
Lancet



Mclean
SV-1236-00



Stoll
SV-1237-15
15 cm



Hall
SV-1238-12
12 cm



Danish Model
SV-1239-13
13 cm



USA-Model
SV-1240-12
12 cm



Greene
SV-1241-15
15 cm



SV-1442-18
18 cm



Danish Model
SV-1243-18
18 cm



Christensen
SV-1244-15
15 cm



SV-1247-11
11 cm
SV-1248-14
14 cm

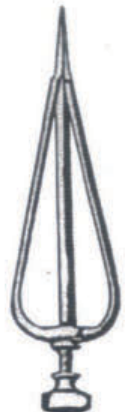

SV-1249-10
10 cm
short model



Schecker
SV-1250-11
11 cm



French Model
SV-1251-65 = 6.5 cm
SV-1252-10 = 10 cm
Papillotome



Hug
SV-1253-13
13 cm



Swiss Model
SV-1254-10
10 cm



Barrett
SV-1255-15
15 cm



Self Retaining
SV-1257-09
9 cm



SV-1258-09
9 cm
SV-1259-10
10 cm



SV-1260-10
10 cm



SV-1261-10
10 cm



SV-1262-10
10 cm



Mose
SV-1263-15
15 cm



Ullner
SV-1264-18
18 cm



Cornell
SV-1266-15
15 cm



Swedish model
SV-1265-14
14 cm



SV 1267-45
4.5 cm



SV-1268-45
4.5 cm



Calf and Colt
SV-1180-35
35 cm
Balling gun
Balling guns are also available in different sizes on request



Calf and Colt
SV-1181-31
31.5 cm
Balling gun
Balling guns are also available in different sizes on request



Irrigation Pump
SV-2505-00
180 cm



Stomach Pump
SV-2503-00
Small



Stomach Pump
SV-2504-00
Large



Fricks Pipe
SV-2502-00

Retractor
Also as Mouth Gag



Hobday
SV-1320-25 Blades 25 mm
SV-1320-40 Blades 40 mm
15 cm / 6"



Strawberry Roaring Burr
SV-1322-21
21.5 cm / 8½"



Roaring Burr
SV-1322-21 F
21.5 cm / 8½"
French model with hooks



Roaring Burr
SV-1322-21 A
21 cm / 8½"



Gray
SV-1159-16
16 cm
3 mm dia
for cats



SV-1160-23
23 cm
2.5 mm dia
for Bitch



SV-1161-20
SV-1162-20
SV-1163-20
SV-1164-20
20 cm
for Dogs



Cervix
SV-1165-44
44 cm, 4 mm dia
for Cattle



SV-1166-44
44 cm
8 mm dia

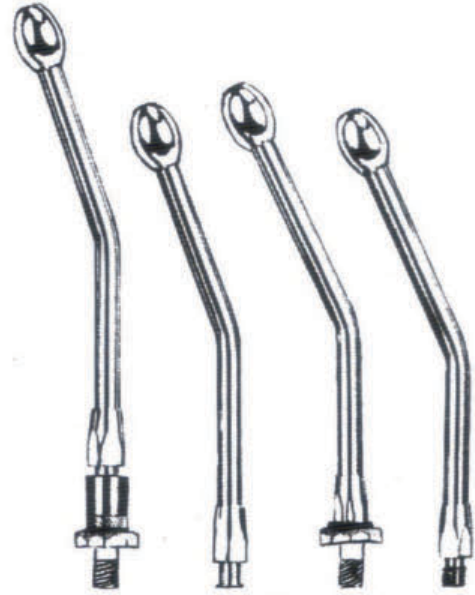

Dose Adaptor

SV-1167-10 10 cm
SV-1168-15 15 cm

SV-1169-10
SV-1170-15



SV-1172-44
44 cm, 5 mm dia
for Cow



SV-1173-30
30 cm
3 mm dia
for dogs



Nielsen
SV-1174-44
44 cm, 5 mm dia
for cow



Imminger / Dawson
SV-1175-23 23 cm
SV-1176-30 30 cm
SV-1177-38 38 cm
for Cow



Heatley
SV-1178-35
35 cm
for Cow



SV-1179-23
23 cm
(Improved Pattern)



SV-2569-55
55 cm



SV-2570-44
44 cm
for Cattle

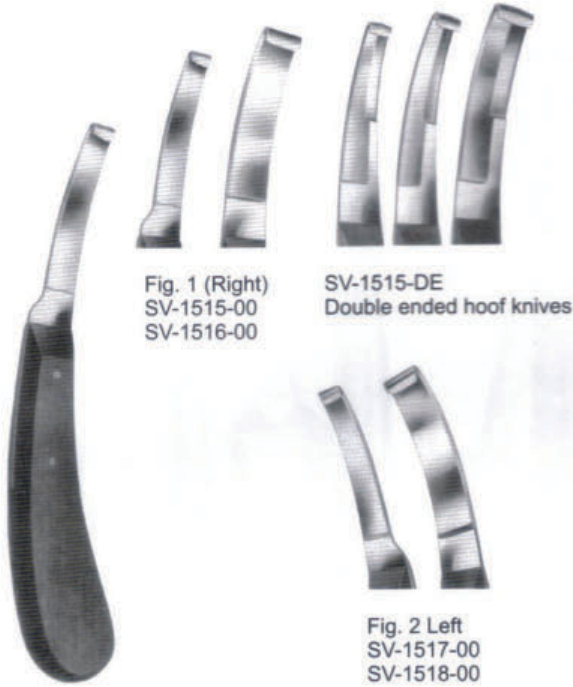

Fig. 1 (Right)
SV-1515-00
SV-1516-00

SV-1515-DE
Double ended hoof knives

Fig. 2 Left
SV-1517-00
SV-1518-00

Hoof Knife
20 cm



Hoof Knife set
SV-1519-00
Wooden Handle and
interchangeable blades



Aluminium Handle
SV-1520-16
16 cm

Dick, Scraper
SV-1521.00

Dick (Buffers)
SV-1523-16
16 cm

Dick (Buffers)
SV-1522-16
16 cm

SV-1524-00

SV-1524-00S

SV-1524-00L

SV-1524-30
30 cm



Avery / Buss
SV-1525-25
25 cm



SV-1526-00
With Wooden Handle



Wamberg
SV-1527-00
spavin



SV-1528-00



SV-1529-18
18 cm
Solid Forged



French
SV-1530-18
18 cm



SV-1531-18
18 cm



French Patta
SV-1532-18
18 cm



Quittor
SV-1533-18
18 cm



SV-1723-30
30 cm
Hoof Tester, Light Model
stainless steel



SV-1723-34
Hoof Tester
Heavy Duty
34 cm
stainless steel

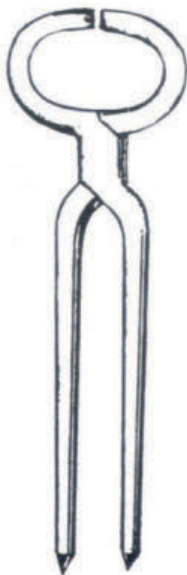

Heavy
SV-1534-34
34 cm
Heavy Pattern



SV-2507-36
Hoof Tester
Wein Model
36 cm
stainless steel



SV-2508-45
Bowening Hertsch
44.5 cm
stainless steel



Folding Hoof Tester
SV-1021-00

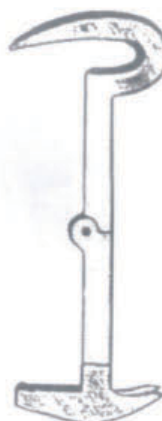

Foot Rot

SV-1535-24
24 cm
Heavy ModelSV-2571-00
Light ModelDick
SV-1539-40 40 cm
SV-1540-50 50 cmSV-1542-00
Pick and Hammer
FoldingFarrier
SV-1543-00
JemmyHoof Buffer
SV-2572-00SV-1544-30
30 cmFarrier
SV-1546-30
30 cm

SV-2573-00



SV-2574-00



SV-2575-00



SV-2576-00



SV-2577-00



SV-2578-00



SV-2579-00



SV-2580-00

Hoof Blade



Din
SV-1549-30
30 cm

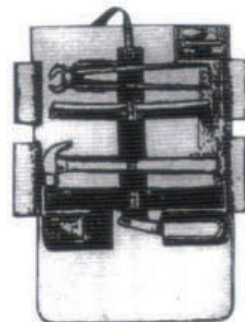

Farrier
SV-1550-00
standard set

Aluminum Made
for dog's ear docking



SV-1554-12 12 cm
SV-1555-15 15 cm
straight



SV-1556-12 12 cm
SV-1557-15 15 cm
curved

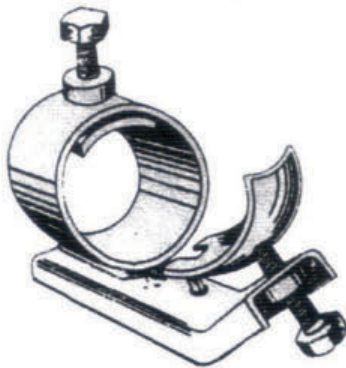

Hornfisher
SV-1558-03 3 cm
SV-1721-38 3.8 cm
SV-1722-48 4.8 cm



Barnes
SV-1559-00



Barnes
SV-1559-11



Gould
SV-1560-26
26 cm



Roberts
SV-1562-13
13 cm

10 cm / 4"



SV-1563-26
26 cm



Staunching

Schecker
SV-1565-31
31 cm

Tourniquets



SV-1566-00
Rubber



SV-2581-00



SV-2582-00

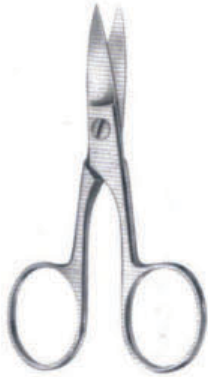

J-40-001 9 cm / 3½"
J-40-010 10 cm / 4"
J-40-020 11 cm / 4½"



J-40-030
J-40-040
J-40-050



J-40-060
10 cm / 4"



J-40-070
10 cm / 4"



J-40-080
10 cm / 4"



J-40-090
11.5 cm / 4½"

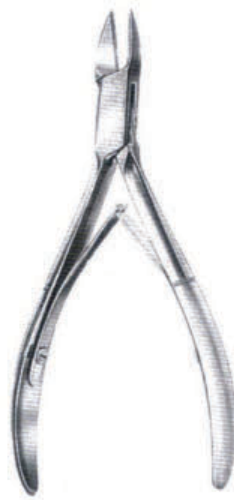

J-40-081 11 cm / 4½"
J-40-082 13 cm / 5"
J-40-083 15 cm / 6"



J-40-091
12 cm / 4¾"



Toe Nail Scissor
SV-2601-00
Angled



Bird Scissor
SV-2506-00
13.5 cm



Hobday
SV-1578-10
10 cm
For Toe Nail



J-40-100 14 cm / 5½"
J-40-110 16 cm / 6¼"

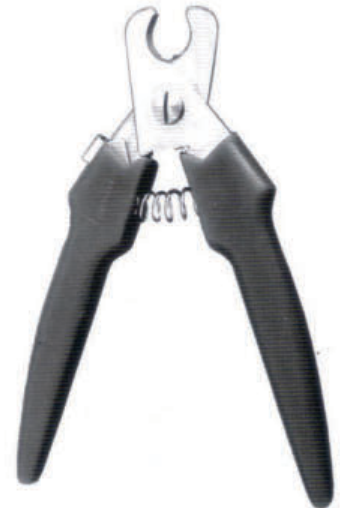

Toe Nail
SV-2602-00
Heavy Duty



J-40-099
13 cm / 5"



Turnbull
J-40-130 11.5 cm / 4½"
J-40-140 13 cm / 5"



J-40-141
14 cm / 5½"

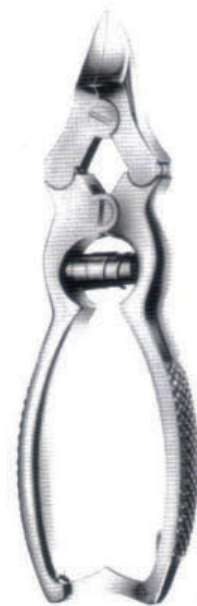

J-40-135
15.5 cm / 6"

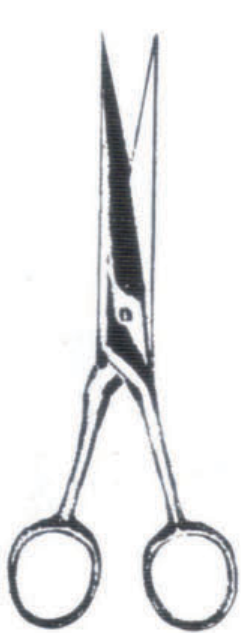

SV-1582-00

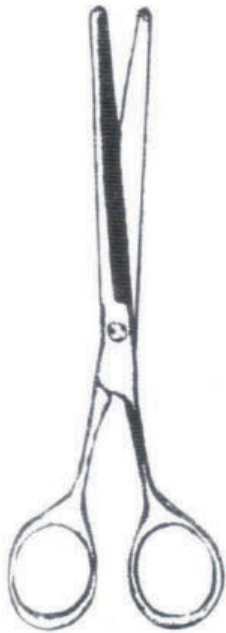

SV-1583-00



SV-1584-00

SV-1585-18
188 cmSV-1586-18
18 cm

SV-1587-00

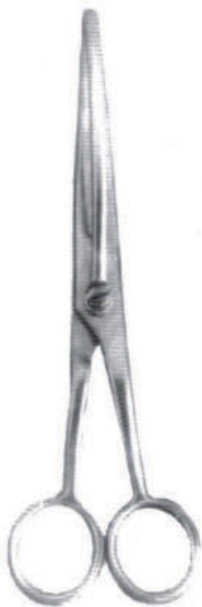

SV-1589-00

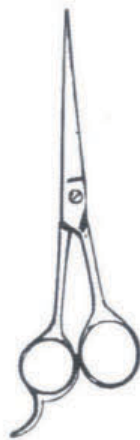
SV-1590-00
Cutting ScissorSV-1591-00
Thinning ScissorGuillotine
SV-1592-00SV-1593-00
For Horses and Cattle



SV-1594-25
25 cm
for Sheep



SV-1594-00



SV-1727-00
for Dogs



SV-2516-00
Small, Straight



SV-2517-00
Small, Angled



SV-1595-00
Large, Angled



SV-1596-00
Large, Straight



Ear Notcher
SV-1597-13
13 cm
Aluminum



Ear Marking Plier
20 cm

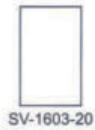

SV-1603-20



SV-1604-20



SV-1605-20



SV-1606-20



Ear Marking Plier
15 cm



SV-1607-15



SV-1608-15



SV-1609-15



SV-1610-15



SV-1611-15



SV-1612-18
18 cm

Punch with spring
for pushing ear out
after cutting

For cutting designs at edge of ears



SV-2550-00

SV-2551-00
20 cm / 8"
Wide toothedSV-2552-00
18 cm / 7"
Narrow and wide toothedSV-2553-00
Dog Combs

SV-2554-00



SV-2555-00

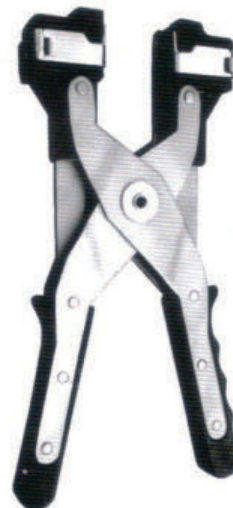

SV-2556-00

SV-2557-00
Tail CutterSV-2558-00
Tagging PliersSV-2559-00
Tagging Pliers



SV-2583-00



SV-2584-00



SV-2585-00



SV-2586-00



SV-2587-00



SV-2588-00



SV-2589-00



SV-2590-00



SV-2591-00



SV-2592-00



SV-2593-00



SV-2594-00



SV-2595-00



SV-2596-00



SV-2597-00



SV-2598-00

Holloware



Solution Bowls
JH-1000-02
20Z



Solution Bowls
JH-1001-04
40Z



Solution Bowls
JH-1002-06
60Z



Solution Bowls
JH-1003-86
860Z



Cotton Container
JH-1004-00



Dressing Jar
JH-1005-03 03
JH-1006-45 45
JH-1007-05 05
JH-1008-06 06



Sponge Bowl
JH-1009-03 03
JH-1010-04 04
JH-1011-05 05
JH-1012-06 06
JH-1013-07 07
JH-1014-08 08
JH-1015-09 09
JH-1016-10 10
JH-1017-12 12
JH-1018-14 14

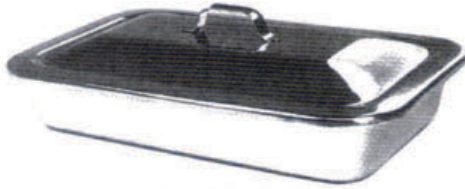

JH-1019-10

JH-1019-10 Top: 10¼" x 6¼" x 2", Bottom: 9" x 5½" x 2"
 JH-1019-12 Top: 12¼" x 8" x 2", Bottom: 10½" x 6¼" x 2"



JH-1020-10

JH-1020-10 Top: 10¼" x 6¼" x 2", Bottom: 9" x 5½" x 2"
 JH-1020-12 Top: 12¼" x 8¼" x 2", Bottom: 10½" x 6¼" x 2"



JH-1021-00

Alcohol Lamp Double Nut

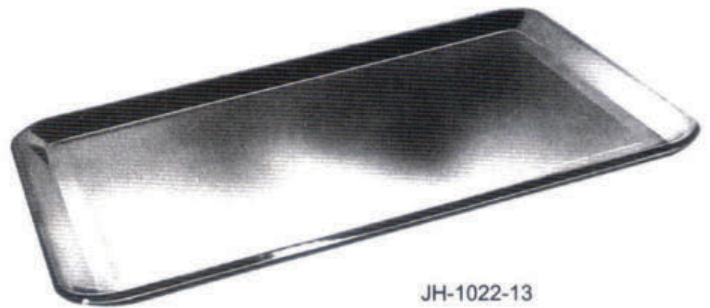

JH-1022-13

Mayo Tray.
 Top: 13¾" x 10" x ¾"
 Bottom: 11¾" x 7½" x ¾"

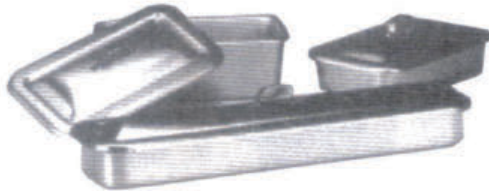

JH-1023-08 Catheter & Instrument Tray with cover and strap handle. 8½" L x 3" W x 1½" H. (22 cm x 7 cm x 3.8 cm.)

JH-1023-12 Catheter & Instrument Tray with cover. Top: 12½" L x 3½" W x 1¾" H (32.4 cm x 9.3 cm x 4.4 cm). Bottom: 12" x 3" x 1¾"



JH-1024-00

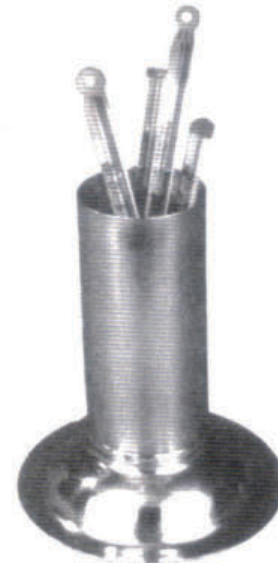

JH-1025-03

Thermometer Jar. Stores glass thermometers. Wide base to give greater stability and avoid air from tipping over. 3¼" H (3.4 cm x 9 cm) x 1½" diameter.



Regular or Economy Bowls: Standard shape. No sharp edges. 12 gauge thickness.

- JH-1026-08 ½ Pin Kitten/Puppy Regular Bowl. (8 OZ.)
- JH-1027-16 1 Pint Regular Bowl. (16 Oz.)
- JH-1028-32 1 Quart Regular Bowl. (32 Oz.)
- JH-1029-69 2 Quart Regular Bowl. (64 Oz.)
- JH-1030-72 2.5 Quart Regular bowl.(72 Oz.)
- JH-1031-96 Quart Regular Bowl. (96 Oz.)
- JH-1032-144 5 Quart Regular Bowl.(144 Oz.)
- JH-1033-216 7½ Quart Regular Bowl.(216 Oz.)
- JH-1034-288 10 Quart Regular Bowl.(288 Oz.)

Premium or Heavy-Duty Bowls: Standard shape with 9-gauge (up to 6-gauge on larger bowls) wall thickness.

- JH-1035-16 1 Pint Premium Bowl. (16 OZ.)
- JH-1036-35 1 Quart Premium Bowl. (32 OZ.)
- JH-1037-69 2 Quart Premium Bowl. (64 OZ.)
- JH-1038-96 3 Quart Premium Bowl. (96 OZ.)
- JH-1039-128 4 Quart Premium Bowl.(128 Oz.)



- JH-1048-00 Dressing Jar. 1-liter capacity
5: H (10 cm x 12.7 cm) x 4" diameter.
- JH-1049-00 Dressing Jar. 2-liter capacity.
6¼"(12.7 cm x 15.9 cm) x 5" diameter.



Non-Tip Bowls: heavy-duty bowl with wide diameter flared base and protective rubber cushion. This make it difficult for animal to tip or knock over bowl. less change for messy water or food spills.

- JH-1040-08 ½ Pint Non-Tip Kitty/ Puppy Bowl.(8 OZ.)
- JH-1041-16 1 Pint Non-Tip Bowl. (16 OZ.)
- JH-1042-32 1 Quart Non-Tip Bowl. (32 OZ.)
- JH-1043-69 2 Quart Non-Tip Bowl. (64 OZ.)



Stainless Steel Pails with Handles.

- JH-1044-02 2 Quart Pail.
- JH-1045-04 4 Quart Pail.
- JH-1046-06 6 Quart Pail.
- JH-1047-09 9 Quart Pail.



- JH-1050-13
Stainless Steel Bucket.
13-quart all-purpose bucket with handle.
Type 304. Stainless. 10¼"H.
Diameter: base-7¾", top 11½".

- JH-1051-13
Round Straight-Sided Pail.
13-quart Stainless steel with handles.
This pail takes up less storage space than conventional pails.

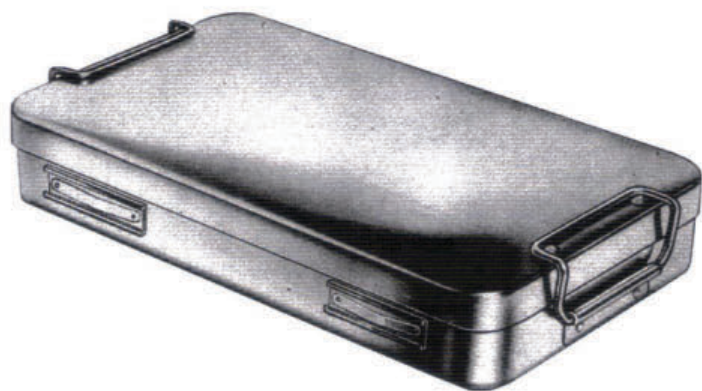

JH-1052-35
height 35 mm
with filter bottom

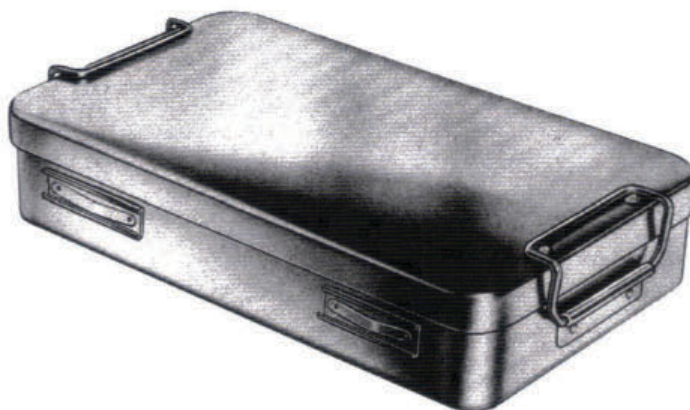

JH-1053-50
height 50 mm
with filter bottom

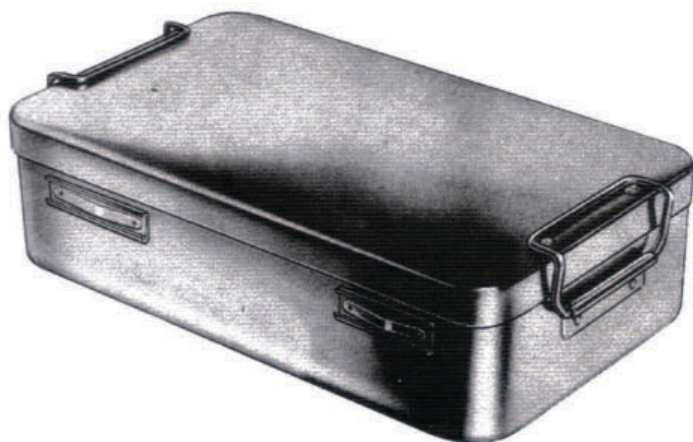

JH-1054-60
height 60 mm
with filter bottom



JH-1055-00
All bottoms with filters

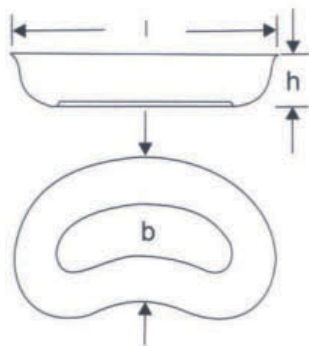

Lid only

JH-1059-25
250 mm x 140mm x 40mm



Bowl only

	Sizes in mm
JH-1056-17	170 x 100 x 35
JH-1057-25	250 x 140 x 40
JH-1058-27	275 x 150 x 45



338 STREET BABAR COMMERCIAL CORNER
LINK MARKET ROAD MODEL TOWN
SIALKOT 51310 – PAKISTAN

PH: +0092- 523-5-7241 – 528-1-03747

FAX: +0092- 523-5-59017

email: info@openaindustries.com , abidbaig8@gmail.com

URL: www.openaindustries.com

CERTIFIED: ISO 9001, ISO 13485, CE Mark, cGMP, CFS