



- Dental
- Surgical
- Veterinary
- Orthopaedic
- Electro

H&H

Impex

Samar Hussain

03142500475

03322901615

samarhussain1@hotmail.com



www.handhimpex.com

Orthopedic Dressing

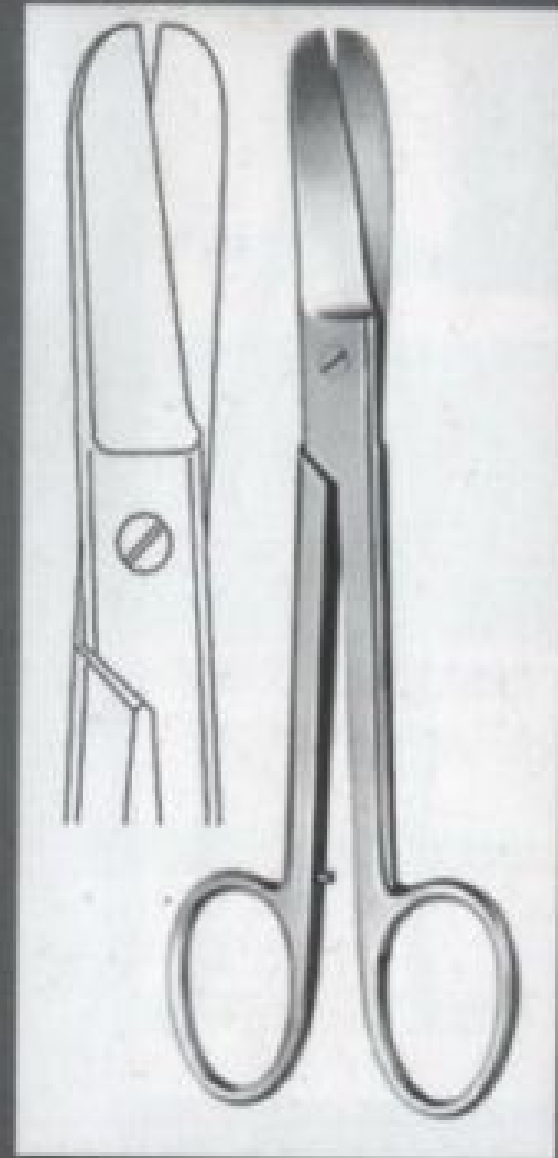

10-200-23 (23 cm/9")
Lorenz Bandage
Scissors Heavy Pattern

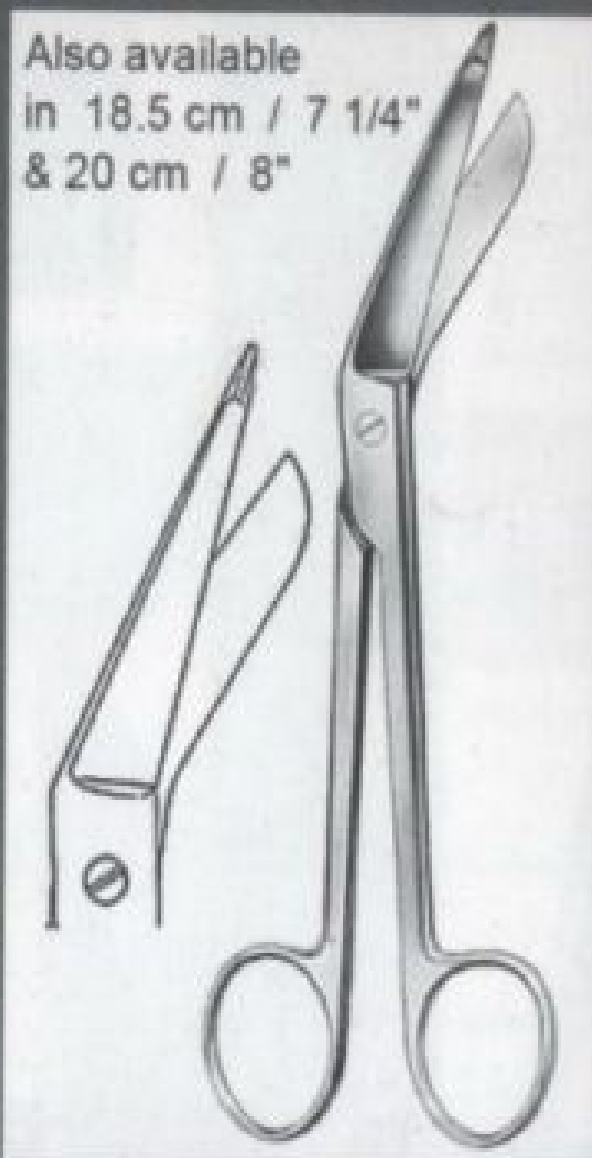

Also available
in 18.5 cm / 7 1/4"
& 20 cm / 8"

10-210-14
Lister Bandage Scissors
14.5 cm / 5 3/4"

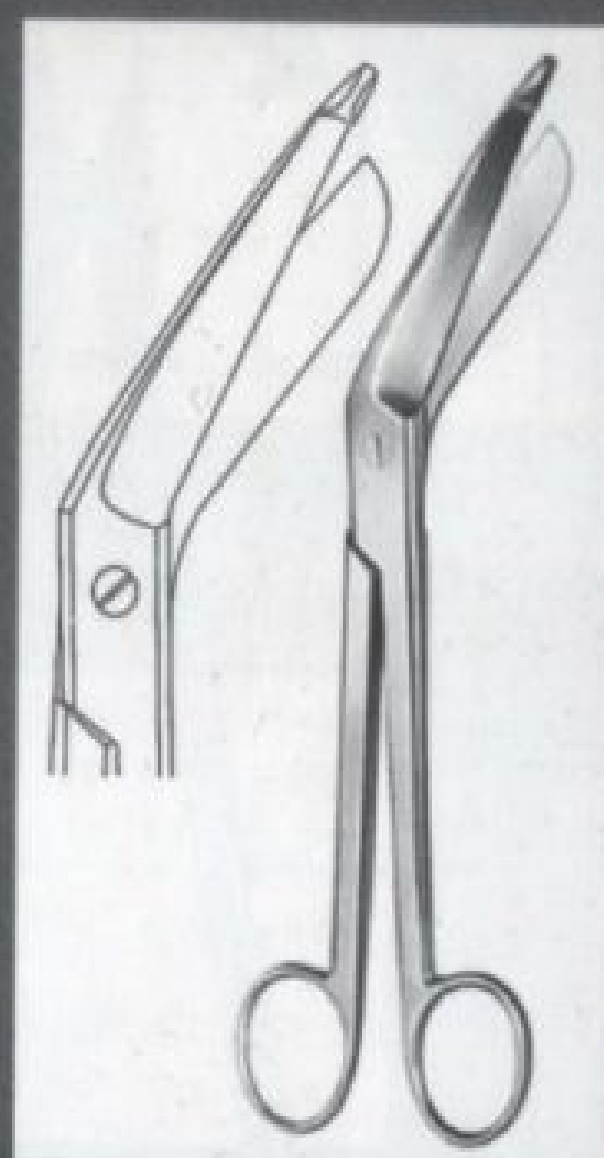

10-220-23 (23.5 cm/9 1/4")
Bergmann Plaster Shears
Heavy Pattern

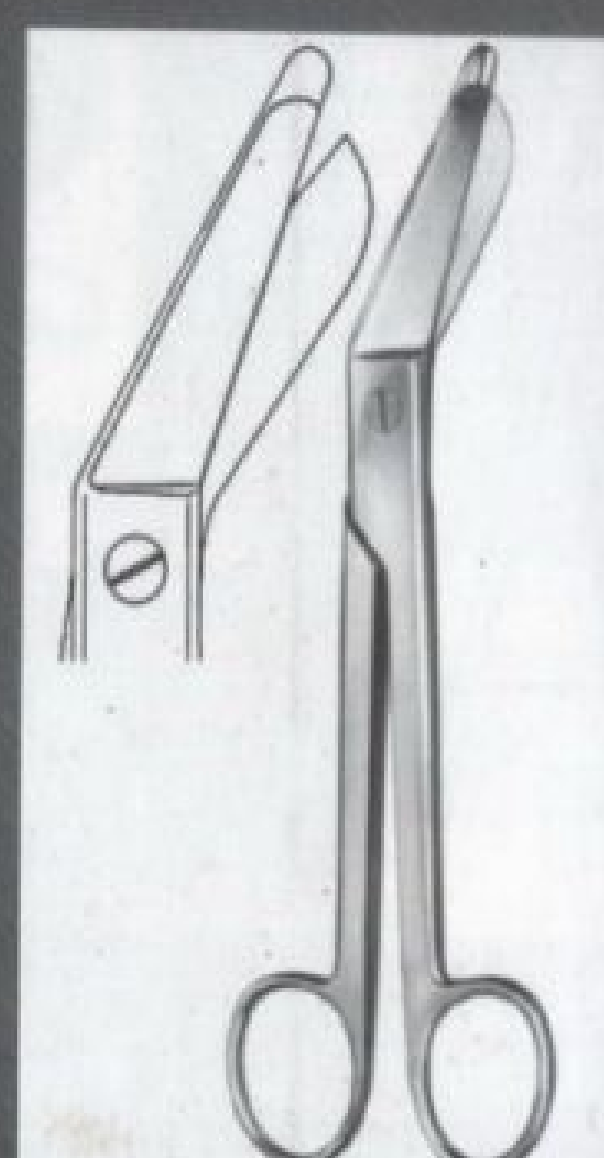

10-230-20 (20 cm / 8")
Esmarch Plaster Shears
Heavy Pattern, Short Blades



Also available
in 18cm / 7 1/2"

10-235-16 (16 cm / 6 1/4")
Bandage Scissors
Black Plastic Rings

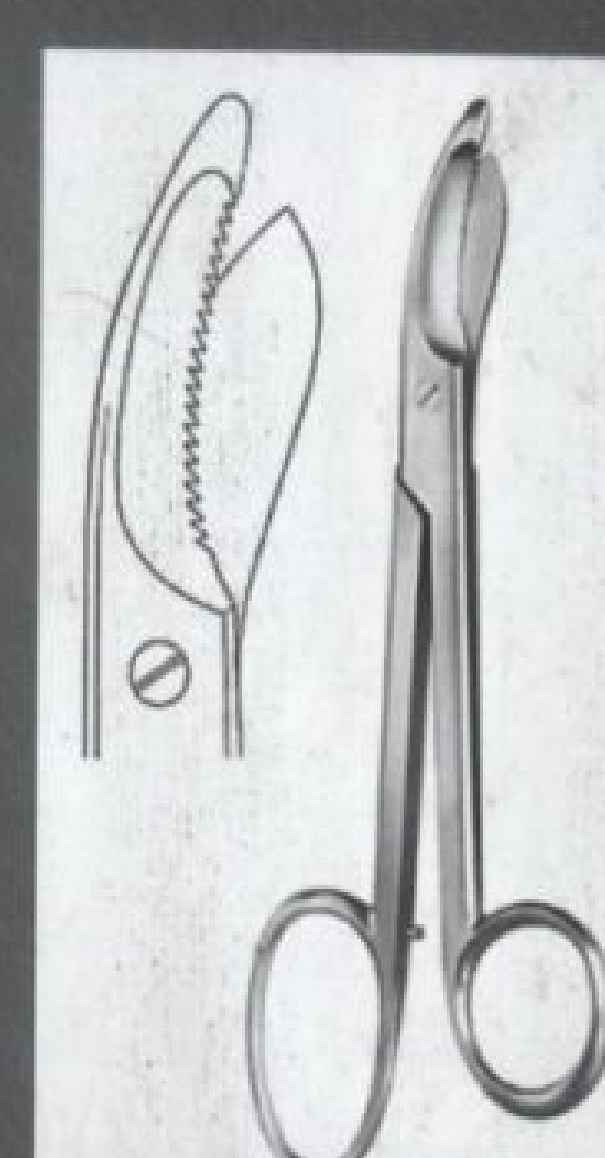

10-250-24 (24 cm/ 9 1/2")
Bruns Plaster Scissors
One Serrated Cutting Edge

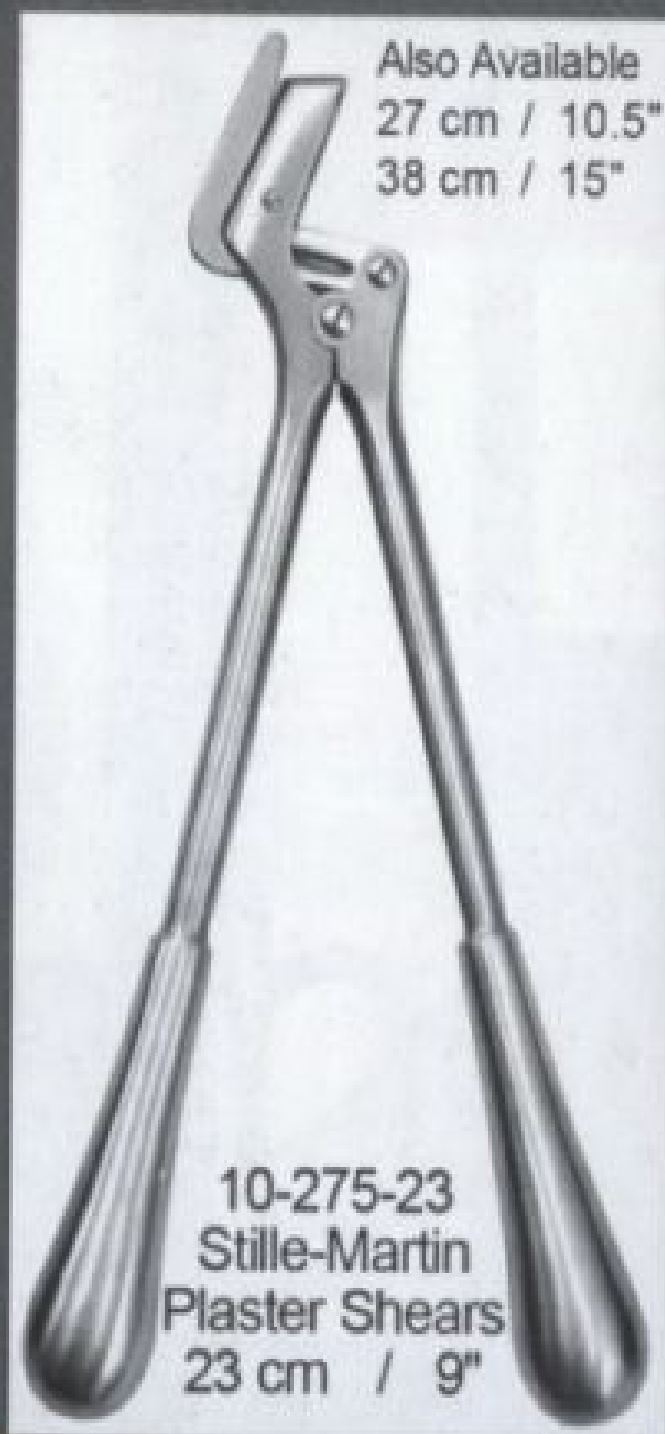

Also Available
27 cm / 10.5"
38 cm / 15"

10-275-23
Stille-Martin
Plaster Shears
23 cm / 9"

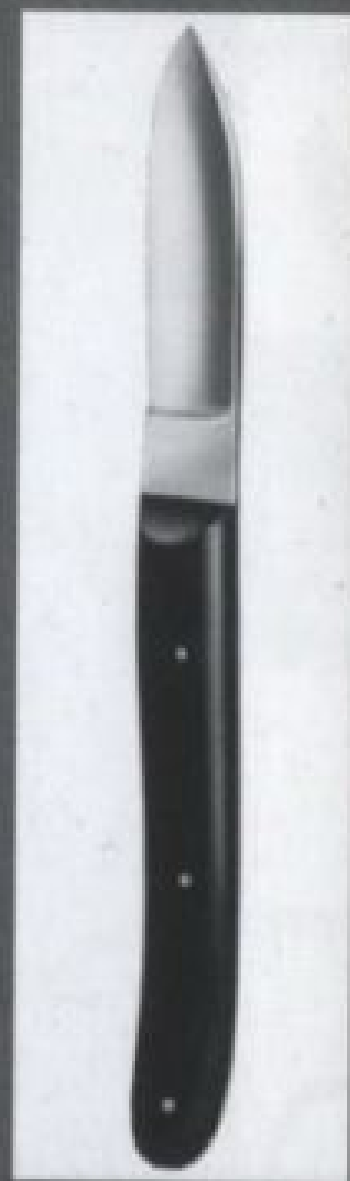

10-320-20
Hopkins Plaster Knife
20 cm / 8"
with Wooden Handle

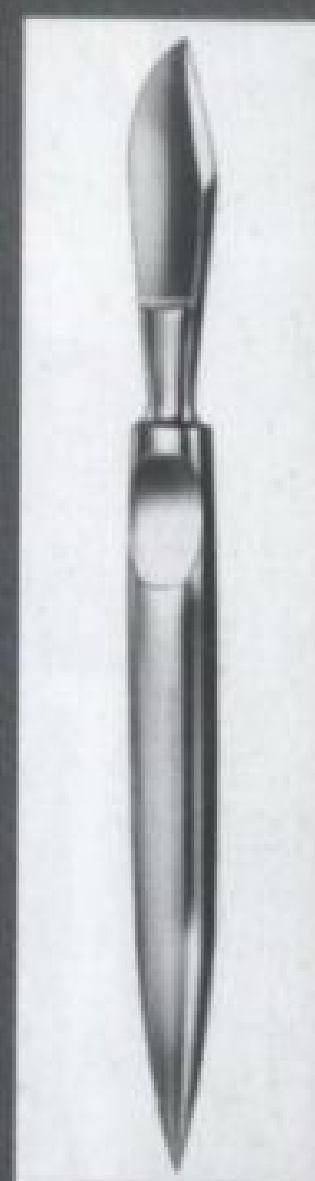

10-350-18
Esmarch
Plaster Knife
18 cm / 7"

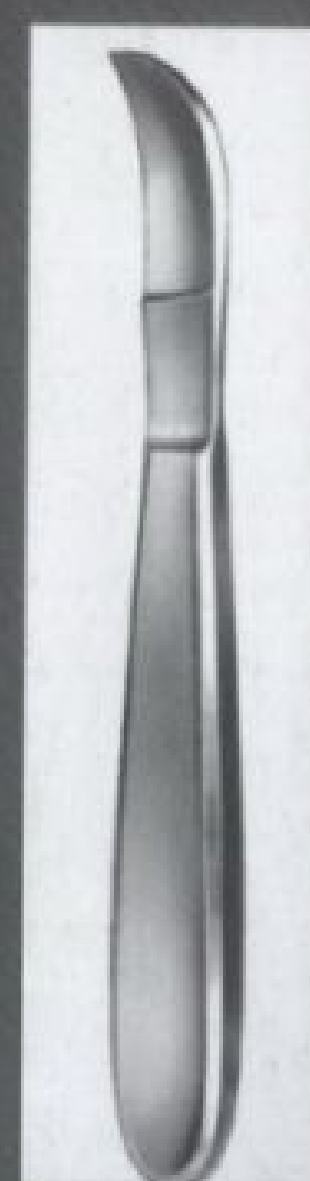

10-355-18
Reiner
Plaster Knife
18 cm / 7"



10-360-21 Martin
Plaster Knife
21 cm / 8 1/4"
with wooden handle



10-395-14
Engel Plaster Saw
15.5 cm / 6"

Orthopedic Dressing

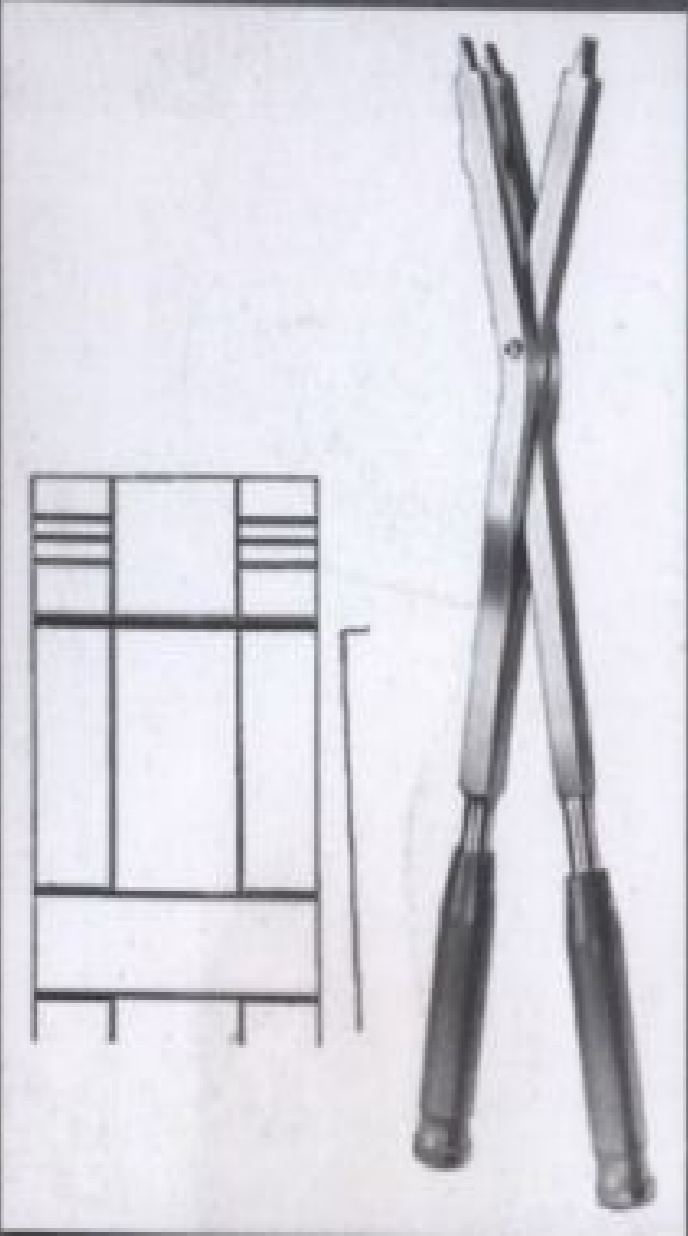

10-430-48
Hermann Plaster Spreader
48 cm / 19"
Heavy Pattern

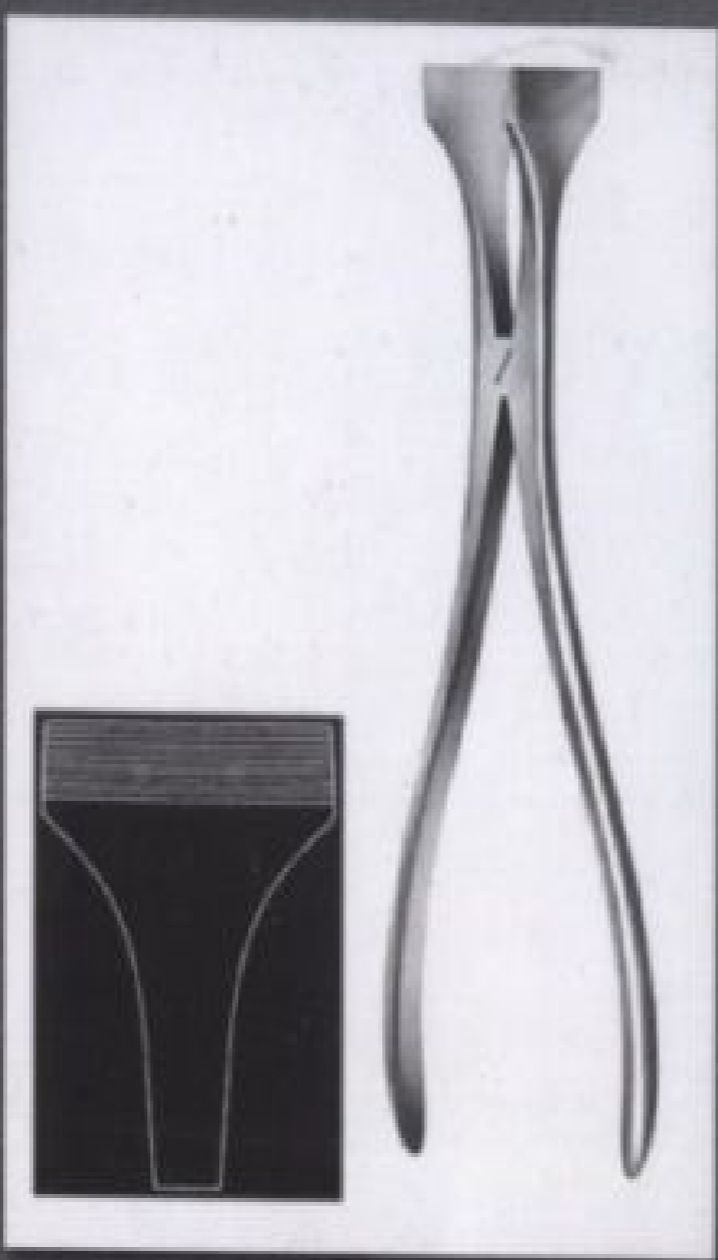

10-433-28
Hennig Plaster Spreader
28 cm / 11"



10-433-30
Hennig
Plaster Spreader
30 cm / 12"

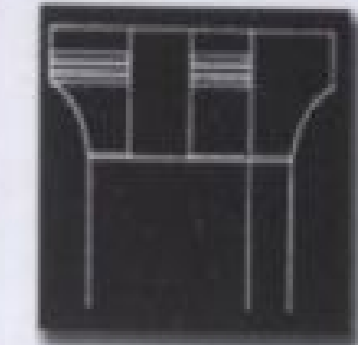
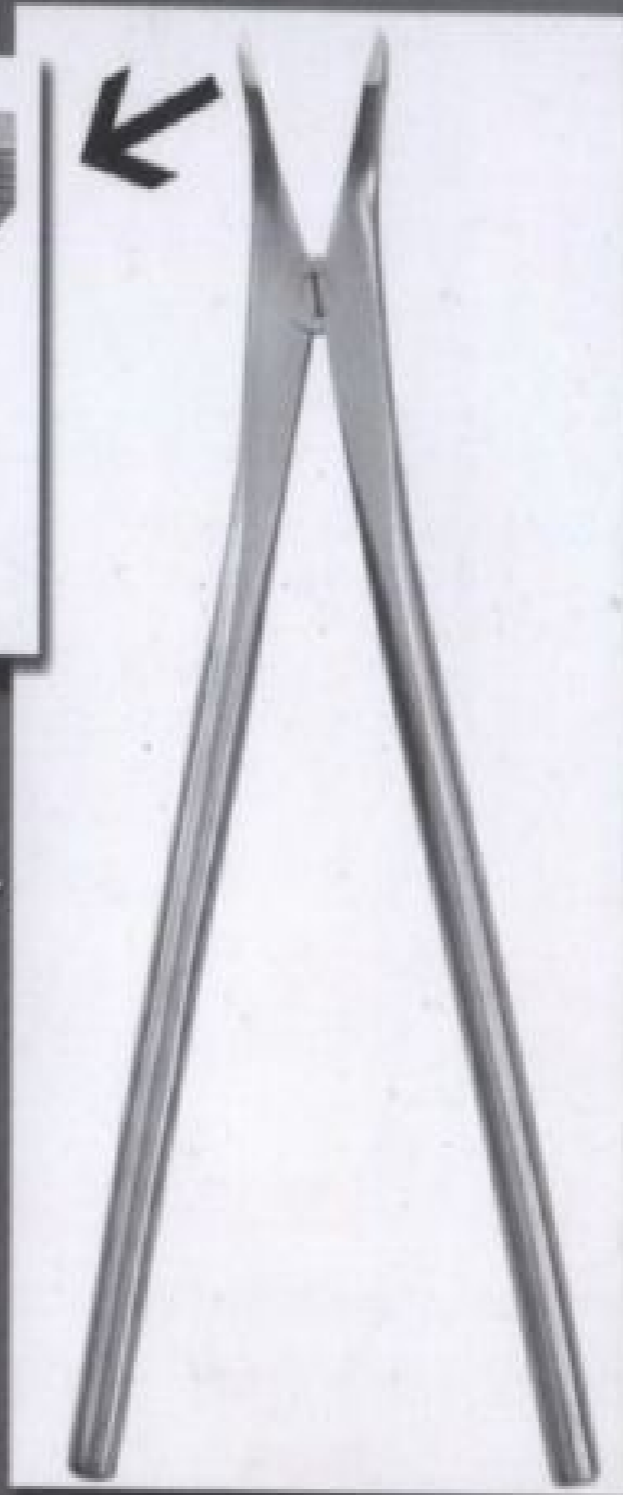

10-435-23
Quattro Plaster Spreader
23 cm / 9"

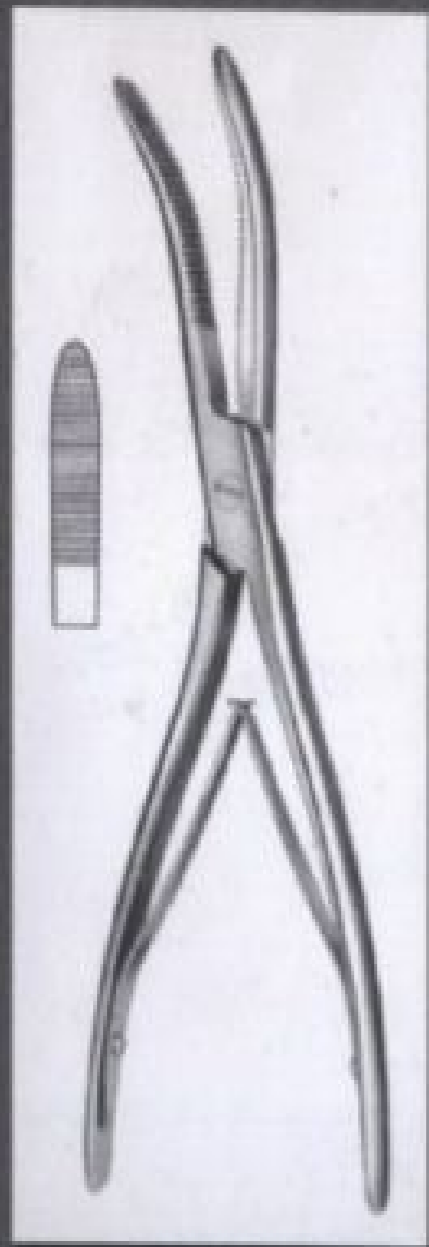

10-455-18
Wolff Plaster Breaker
18 cm / 7"

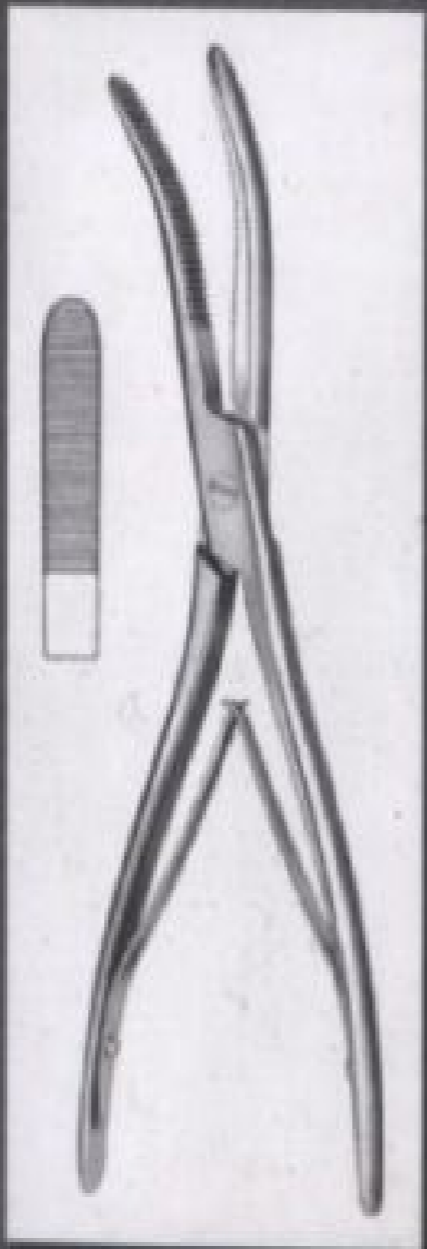

10-460-26
Wolff Plaster Breaker
26.5 cm / 10 1/2"



TC Tipped
TC-200-18
Lister
Bandage Scissors
TC / Handle gold
18 cm / 7"

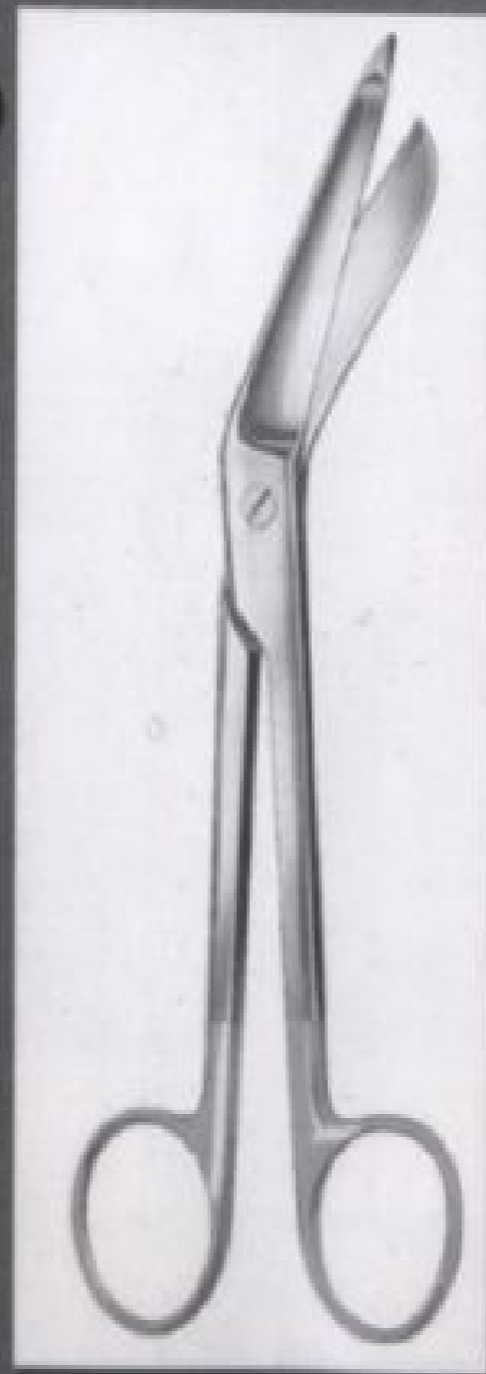

TC Tipped
TC-202-24
Bruns
Plaster Scissors
24 cm / 9 1/2"

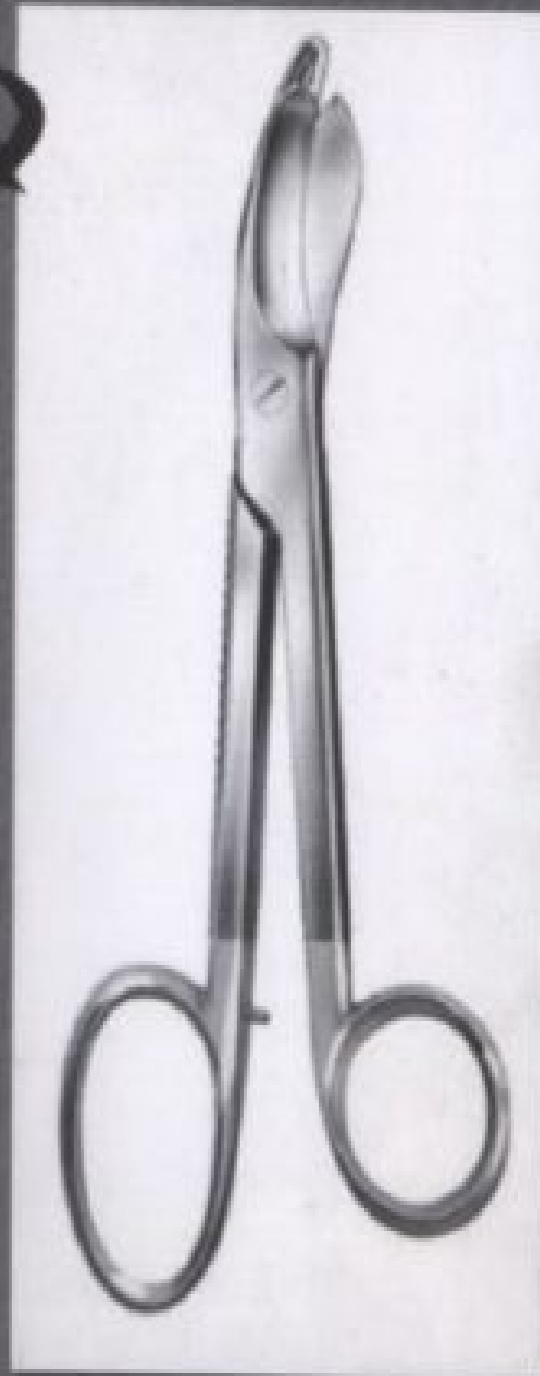

Amputation Saws

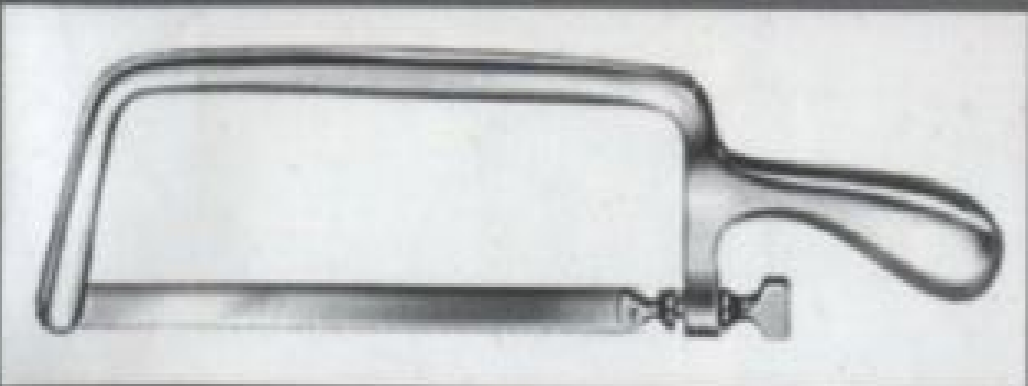

11-101-35
Charrière Amputation Saw
35 cm / 13 3/4"

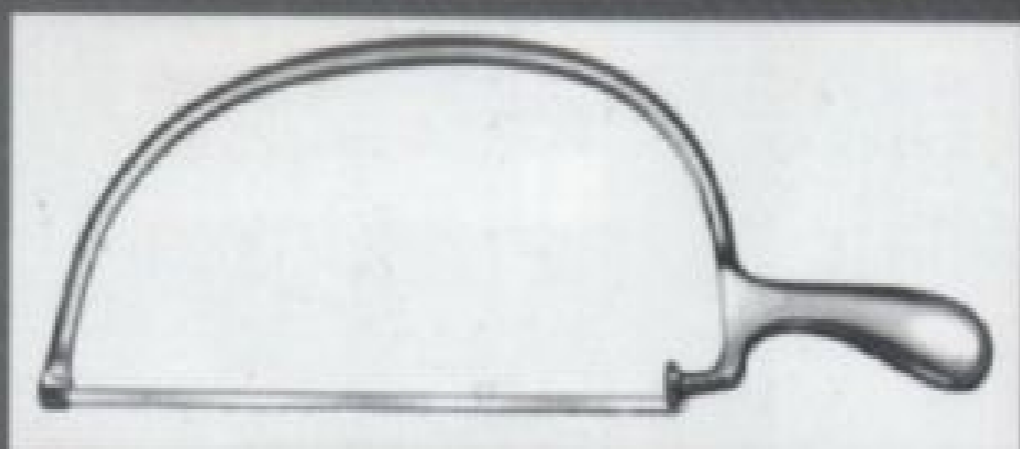

11-105-40
BIER Amputation Saw
40.5 cm / 16"

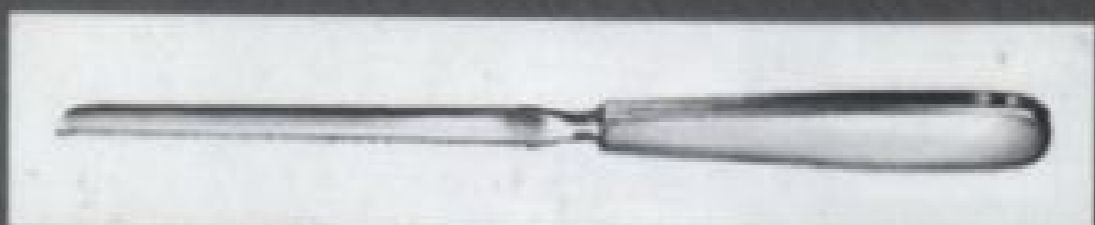

11-112-24
Langenbeck Amputation Saw
24.5 cm / 9 3/4"

11-118-29
Satterlee
Amputation Saw
29 cm / 11 1/2"
Also:
Spare Saw Blade
Available in
20 cm / 8 1/4" Size

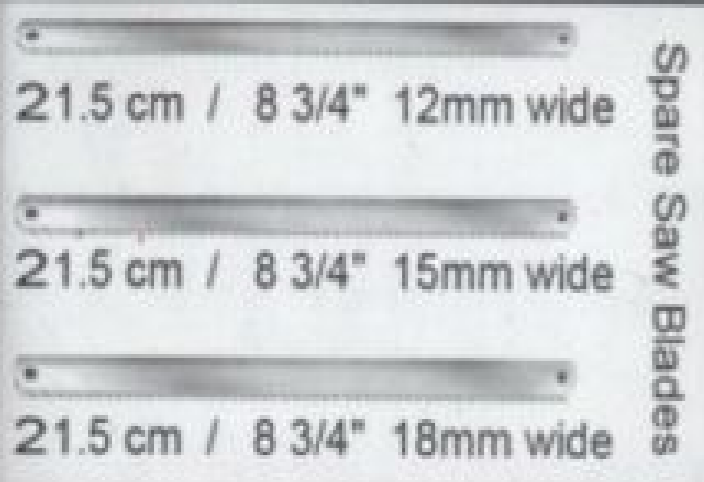
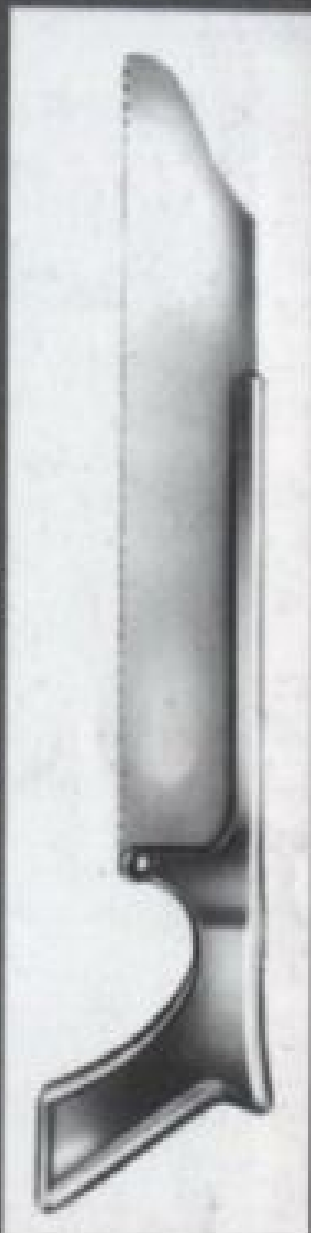

Spare Saw Blades

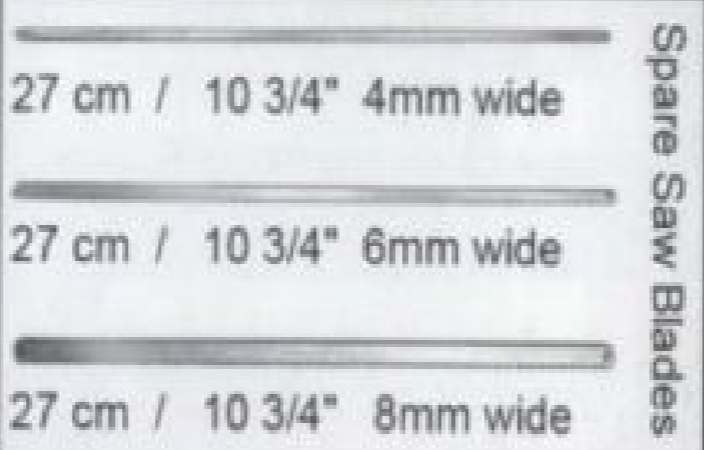

Spare Saw Blades



11-115-27
Charrière Amputation Saw
27 cm / 10 1/2"

Reamers

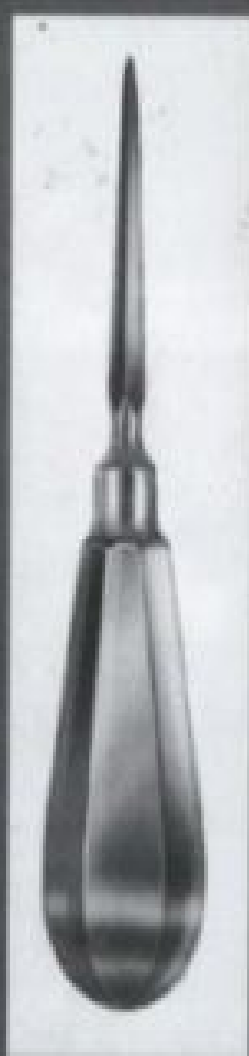

11-128-14
Reamer
3.5 cm / 5 1/4"



11-130-18
Perthes Reamer
18 cm / 7"

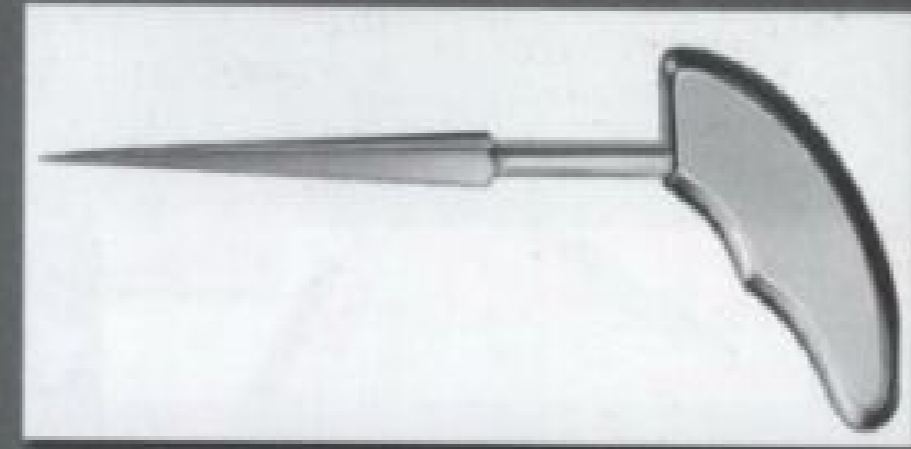

11-132-21
Perthes Reamer
21.5 cm / 8 1/2"

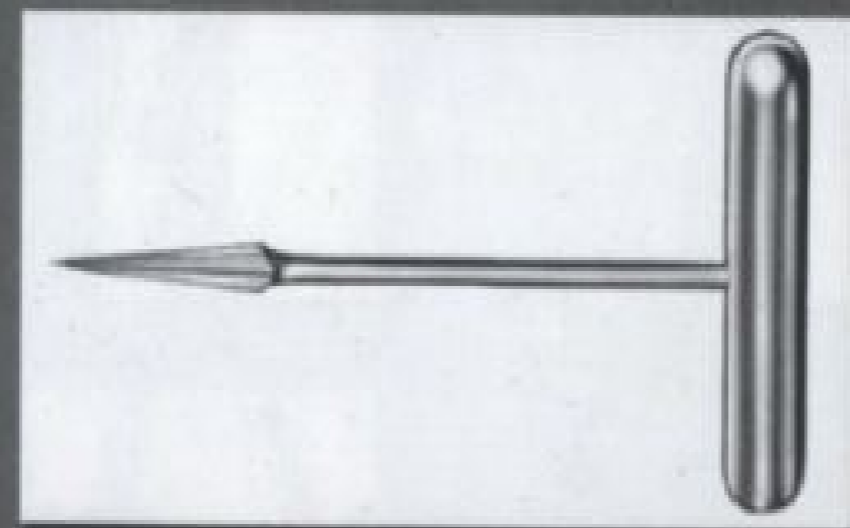

11-134-14
Reamer
One concave side
14 cm / 5 1/2"

Hand Bone Drills

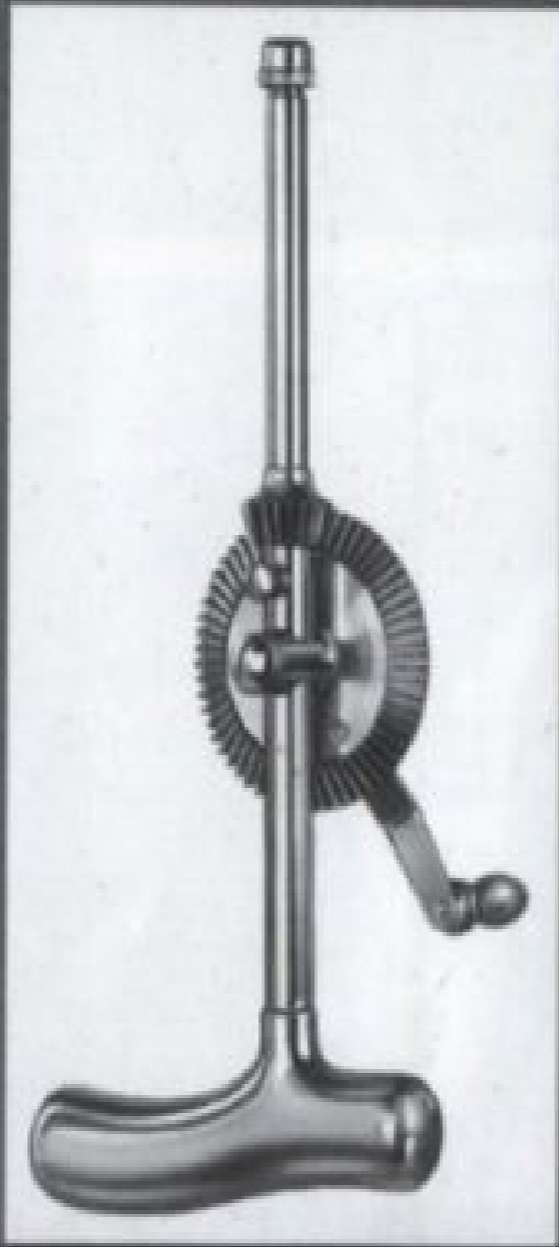

11-138-00
Stille-Sherman Hand Drill
24 cm / 9 1/2"
with 3 twist drills

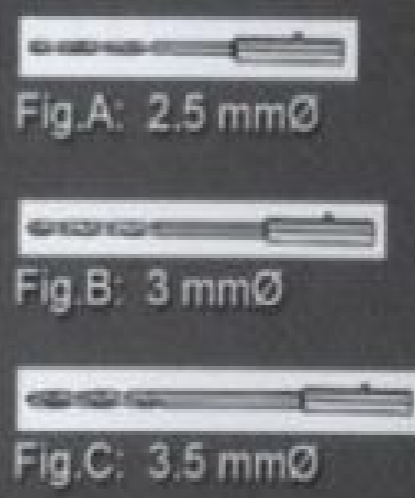

Fig.A: 2.5 mmØ

Fig.B: 3 mmØ

Fig.C: 3.5 mmØ



11-138-01
Stille Hand Drill
20.5 cm / 8"
with 9 twist drills (See Art # 11.138.02 on next page)

Hand Bone Drills

Complete with Hand Drill art # 11-138-01

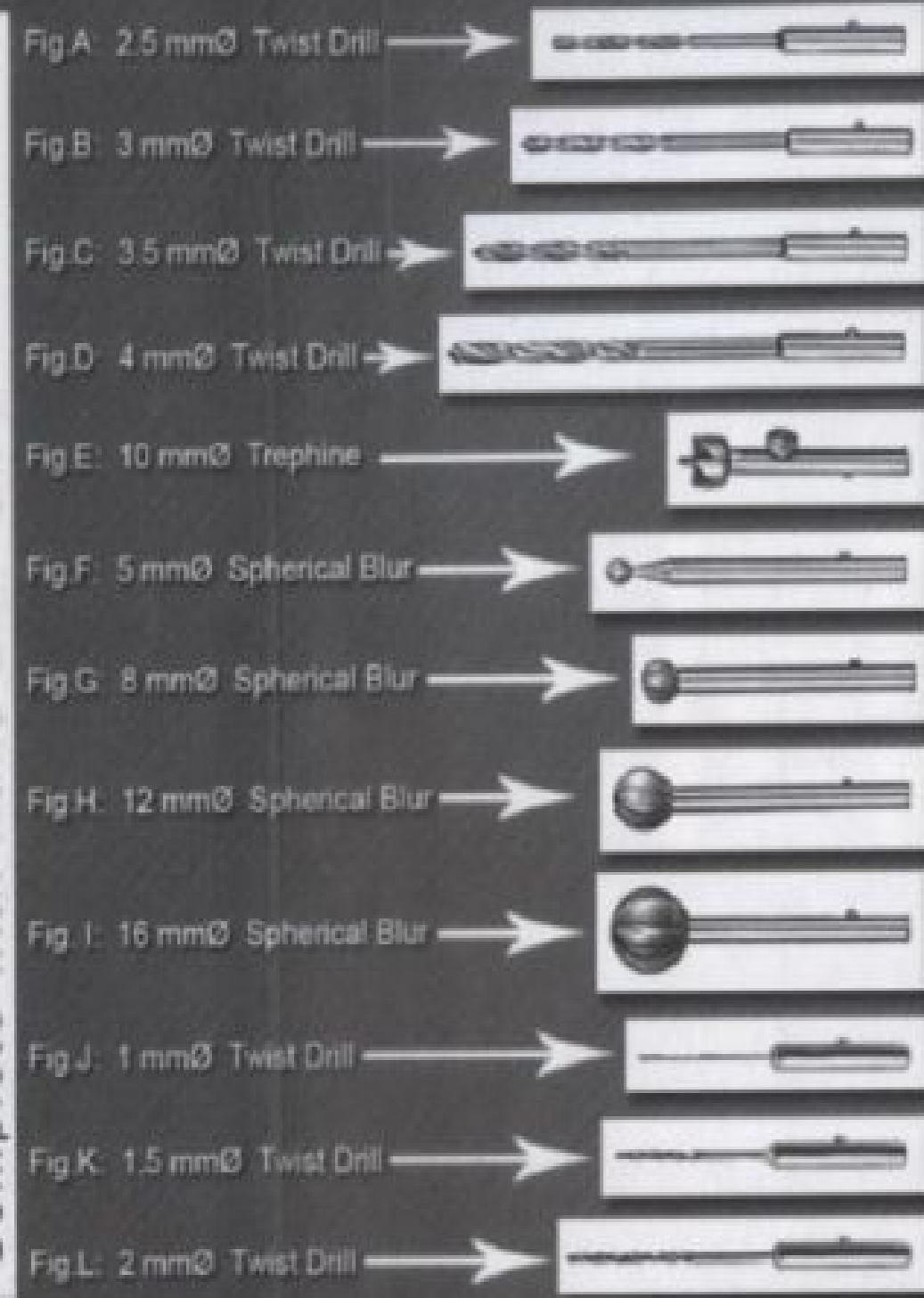

11-138-02

Use with Hand Drill 11-138-01(previous page)

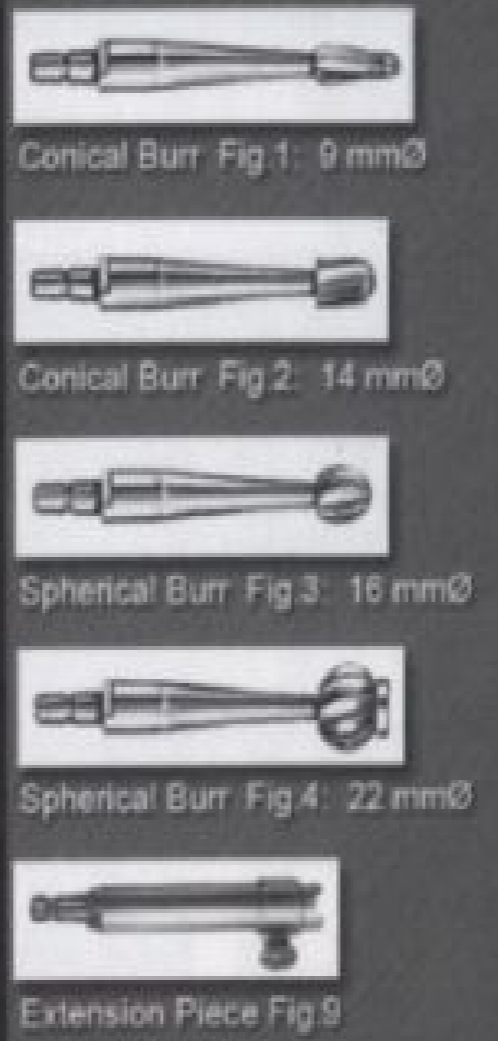

11-145-00
Hudson Hand Drill
28 cm / 11"
complete with burs Fig.#. 1 - 4 and
extension piece # 9.
(pls see art # 11-145-01 for more acc)

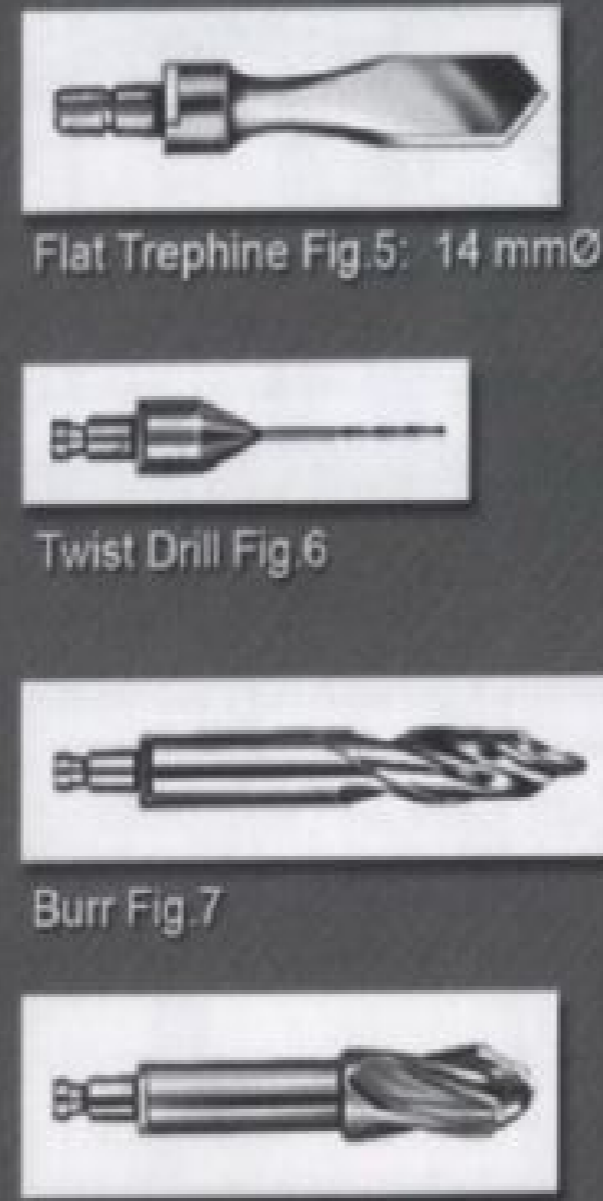
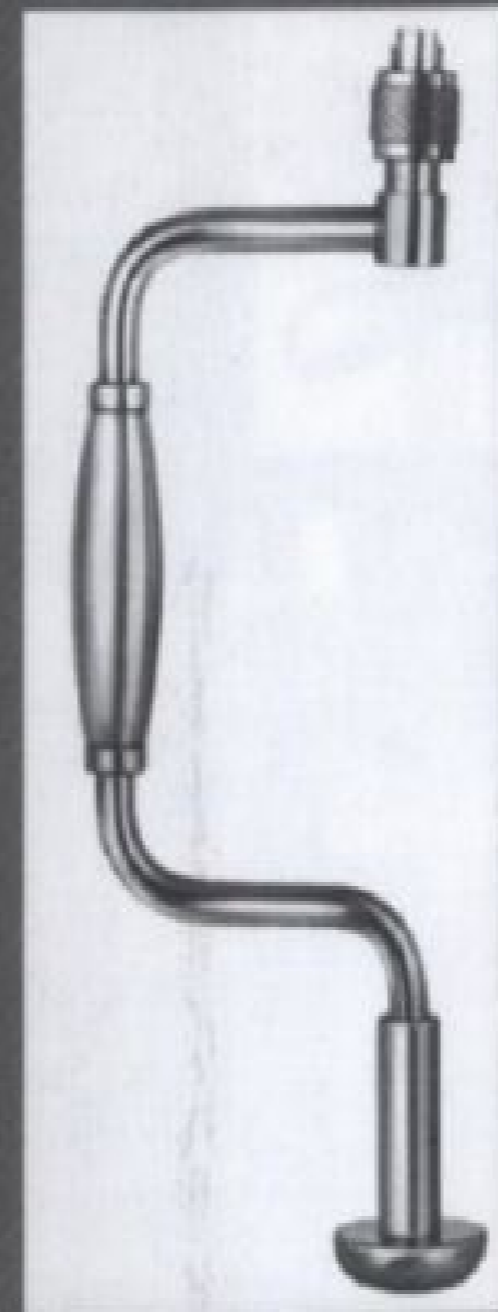

11-145-01
HUDSON (Drills)
(To be used with art #
11-145-00 Hand Drill)

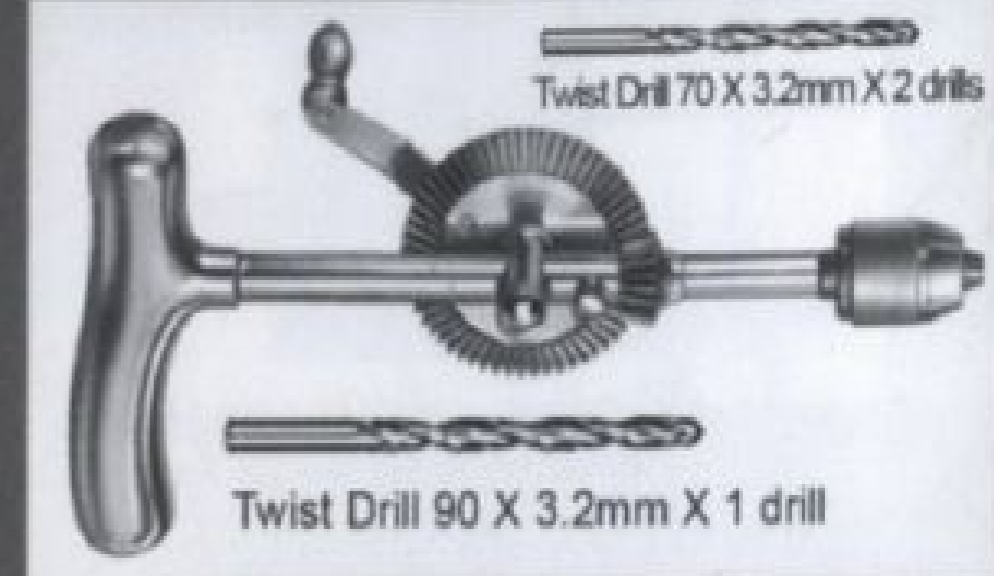

11-150-00 Moore Hand Drill
complete with a set of 3 twist drills

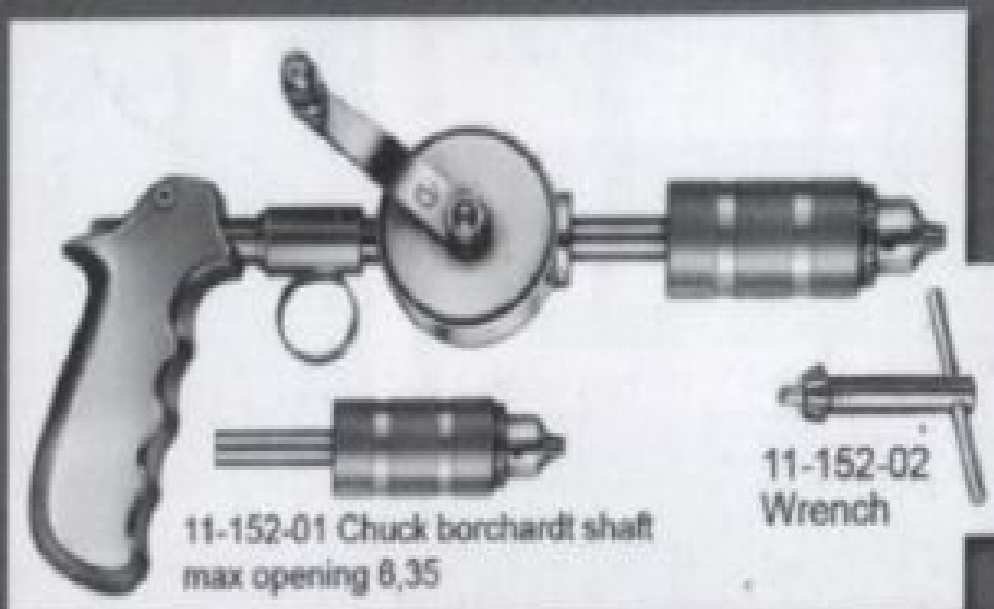

11-152-00
Martin Hand Drill with Chuck & Wrench

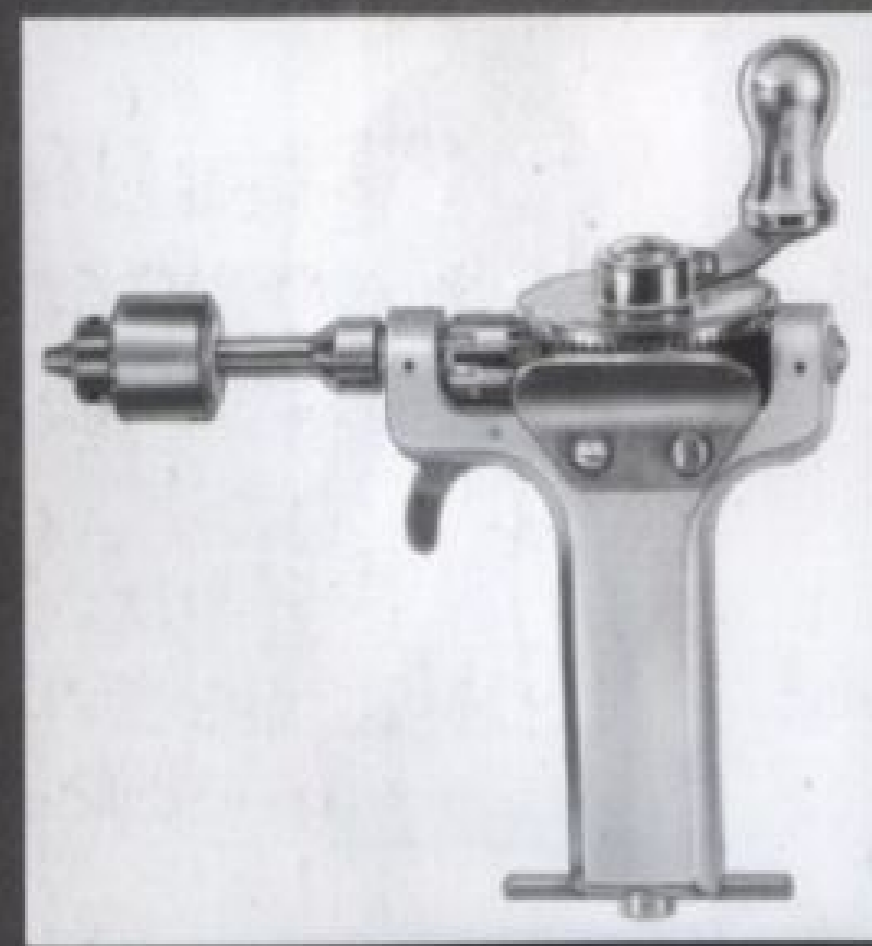

11-410-16
Bunnell Hand Drill 16cm,
Longitudinally bored with three-jaw-chuck
light metal housing
opening up to 4mmØ
11-410-16a spare Key for three jaw-chuck



11-415-00
Ralk Hand Drill
Hand Drill light metal housing
and literally angled handle with three-jaw-
chuck and key, opening up to 6,35mmØ

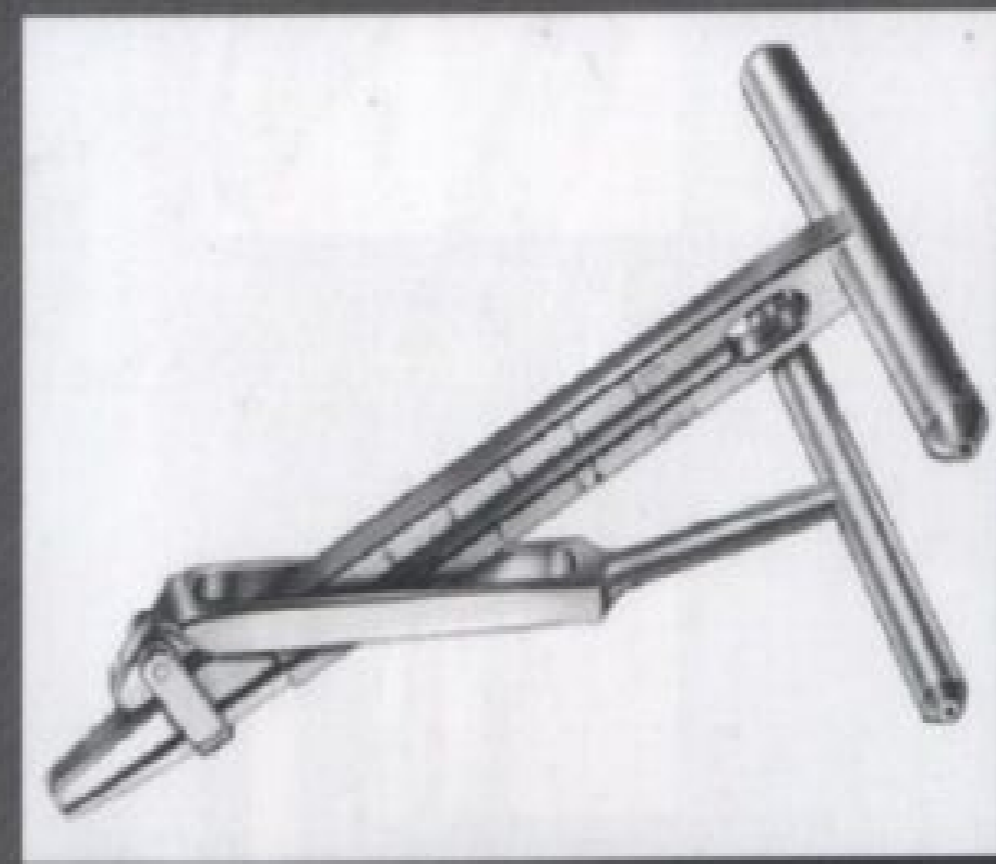

11-420-14
Vickers Easidriver
14 cm / 5 1/2"

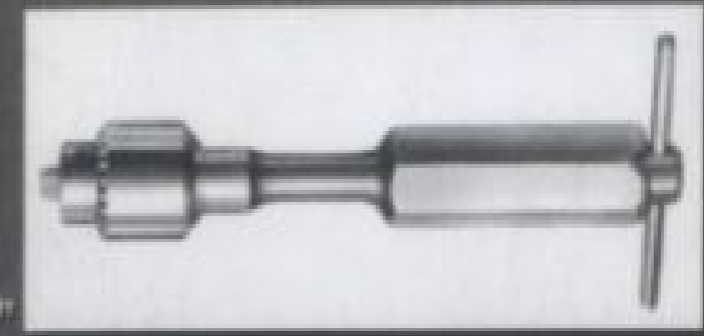

11-426-00
14cm / 5 1/2"
Handle with chuck Longitudinally bored
Accomodating up to 3,95mm

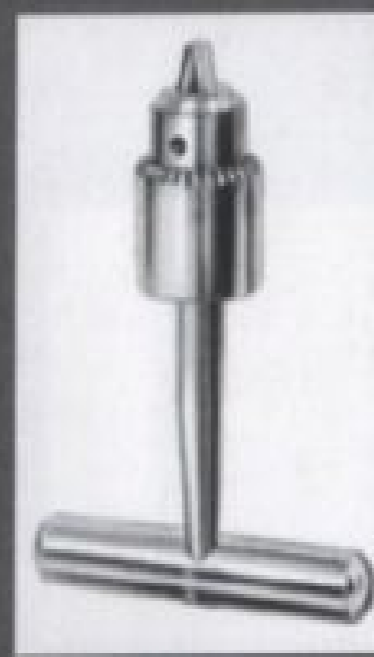

11-425-00
Handle with chuck
T-Shaped



11-425-01
Key

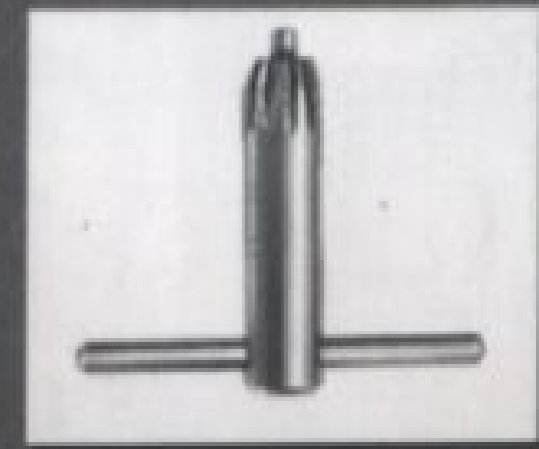

11-426-01
Key

Bone Drills Acc

Available sizes
Length

6cm 10cm 12cm 14cm 16cm 31cm

0.6					
0.8					
1.0	1.0	1.0	1.0	1.0	1.0
1.2	1.2	1.2	1.2	1.2	1.2
1.4	1.4	1.4	1.4	1.4	1.4
1.5	1.5	1.5	1.5	1.5	1.5
1.6	1.6	1.6	1.6	1.6	1.6
1.8	1.8	1.8	1.8	1.8	1.8
2.0	2.0	2.0	2.0	2.0	2.0
2.2	2.2	2.2	2.2	2.2	2.2
				2.5	2.5

Please mention both sizes when placing order

11-430-00
Kirschner Wire Drill
trocar point flat end

Available sizes
Length

6cm 10cm 12cm 14cm 16cm 31cm

1.0	1.0	1.0	1.0	1.0	1.0
1.2	1.2	1.2	1.2	1.2	1.2
1.4	1.4	1.4	1.4	1.4	1.4
1.5	1.5	1.5	1.5	1.5	1.5
1.6	1.6	1.6	1.6	1.6	1.6
1.8	1.8	1.8	1.8	1.8	1.8
2.0	2.0	2.0	2.0	2.0	2.0
2.2	2.2	2.2	2.2	2.2	2.2
				2.5	2.5

Please mention both sizes when placing order

11-432-00
Kirschner Wire Drill
trocar point round end

Available sizes

Length
31cm

1.0
1.2
1.5
1.6
1.8
2.0
2.2
2.5

Please mention both sizes when placing order

11-435-00
Kirschner Wire Drill
lancet point flat end

Bone Holding Clamps

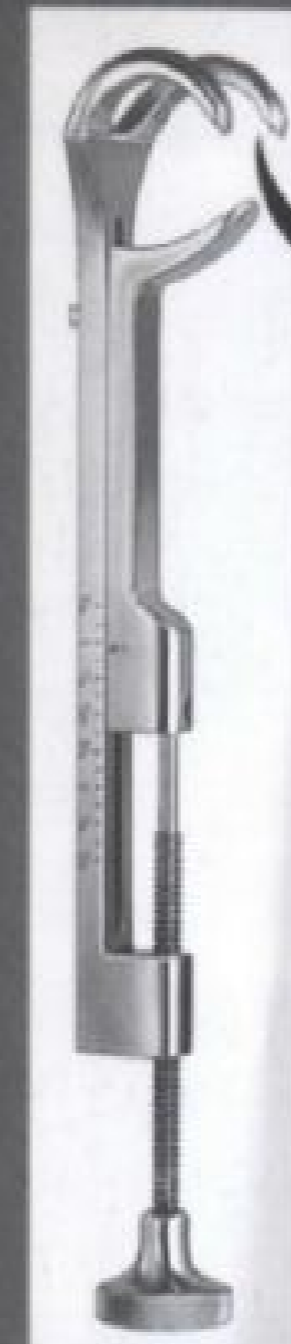

11-200-18
18cm / 7"

11-200-20
20cm / 8"

11-200-22
22cm / 8 3/4"

Gerster-Lowman
Bone Holding Clamp



11-205-15
Gerster Traction Bar
15cm / 6"

Pliers

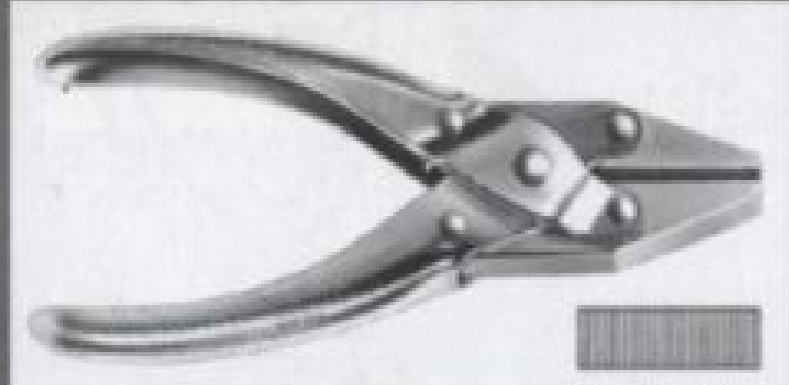

11-300-18
Flat Nose Plier 18.5 cm / 7 1/4"
parallel grip Stainless Steel

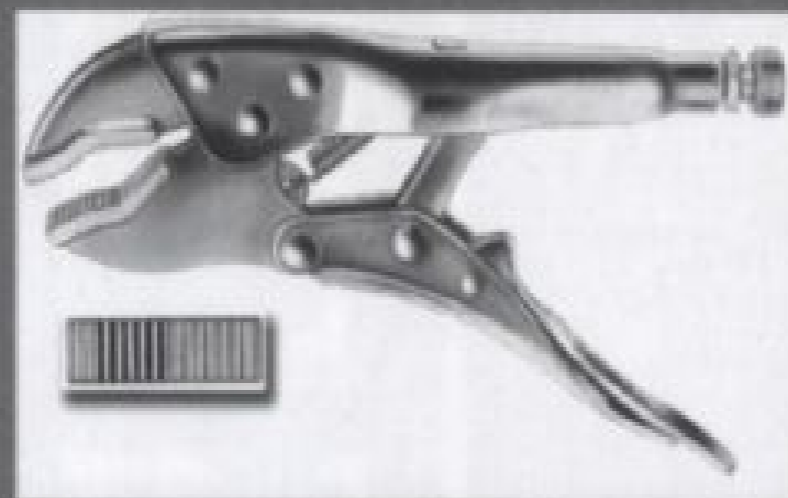

11-305-20
Vise Grip 20.5 cm / 8"
Stainless Steel

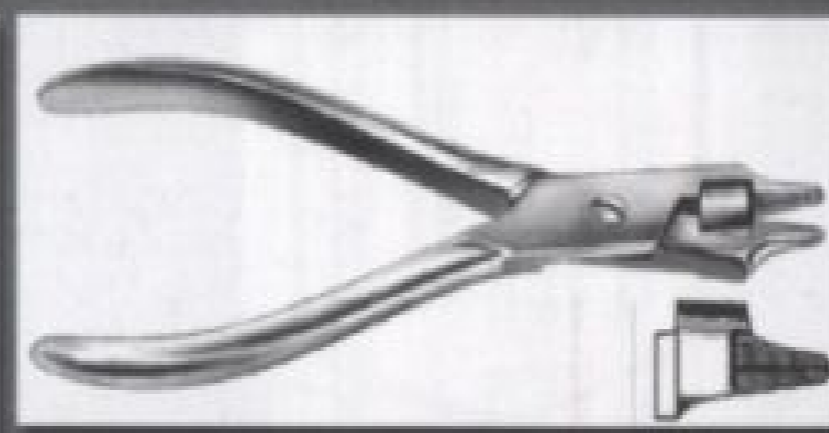

11-310-15
Combi-Flat Nose Plier 15 cm / 6"
for bending and cutting

11-318-17B
Flat Nose Plier
17 cm / 6 3/4"
with crosswise groove

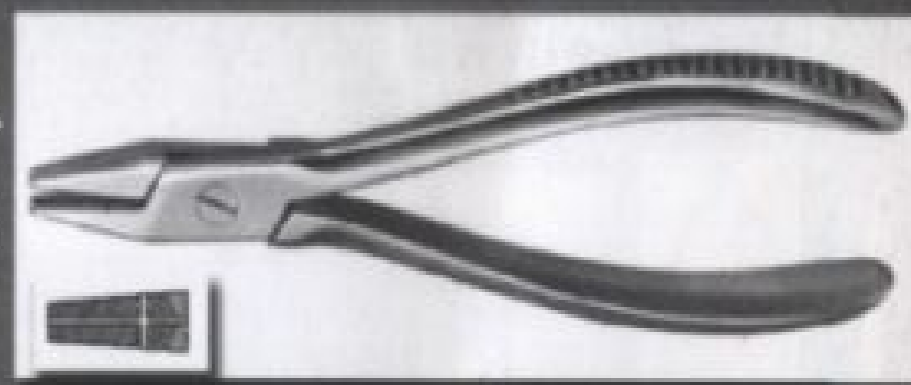

11-310-18a
11-310-18b
11-310-18
Flat Nose Plier
18 cm / 7"
Parallel Grip

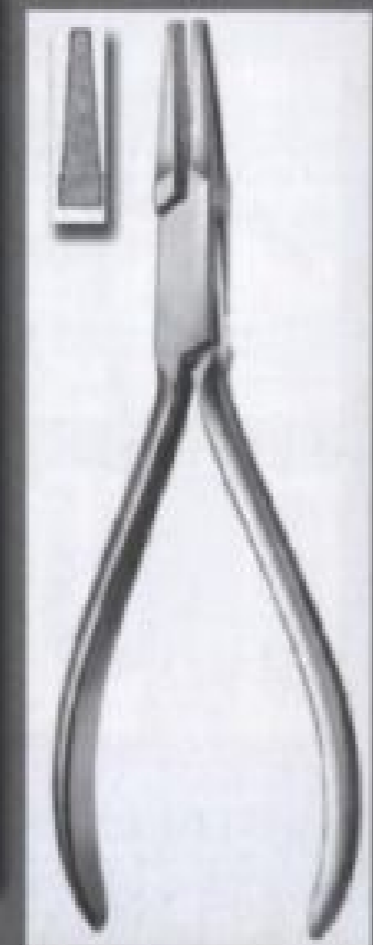

11-315-14
Flat Nose Plier
13.5 cm / 5 1/4"



11-315-18
Round / Flat
Nose Plier
18 cm / 7"



with longitudinal groove
11-317-16
Hackstock Flat
Nose Plier
16cm / 6 1/4"

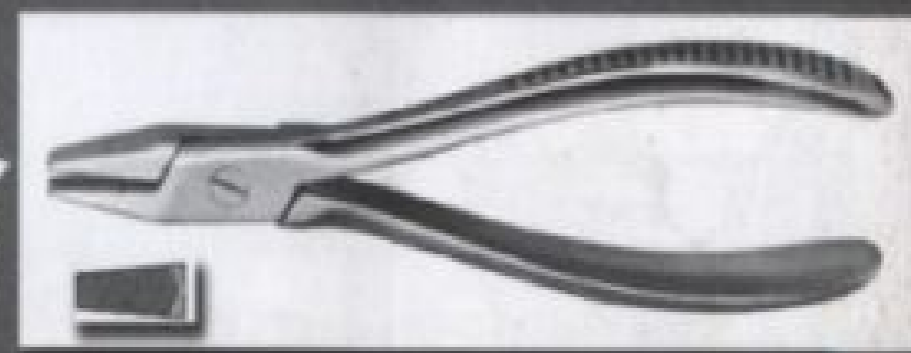

11-318-17
Flat Nose Plier
17.5 cm / 7"

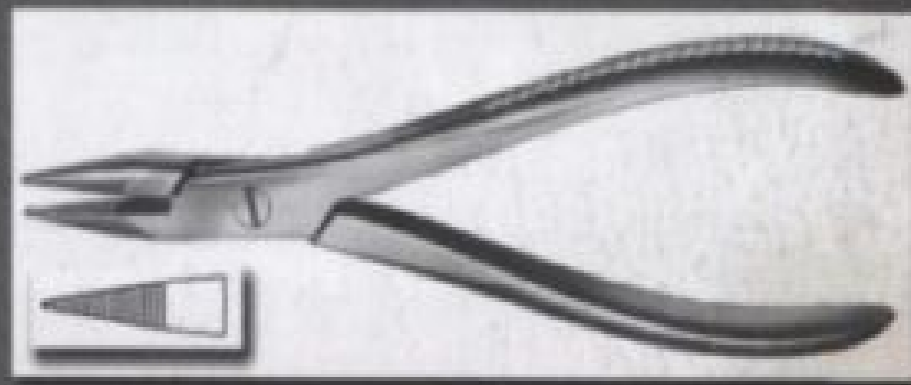

11-318-19
Flat Nose Plier, pointed
19.5 cm / 7 3/4"

Wire Cutting Pliers / Acc

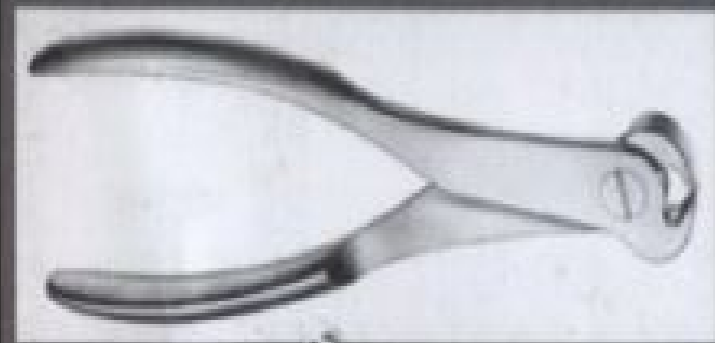

11-320-18
18.5 cm / 7 1/4"
Soft wires up to 2.4mm Ø
Hard wires up to 1.8mm Ø

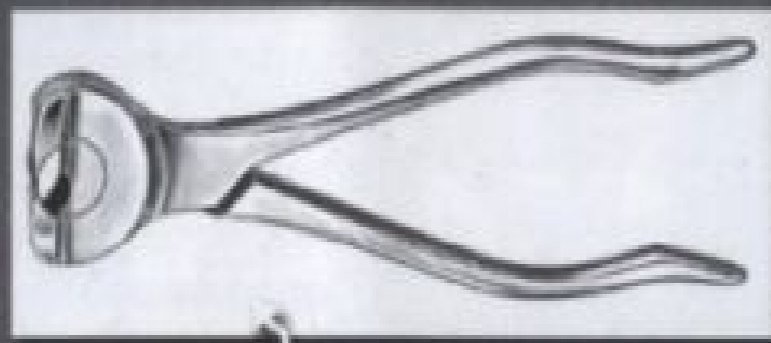

11-322-16
Martin "Diamant" (16 cm / 6 1/4")
Soft wires up to 2.2mm Ø
Hard wires up to 2.0mm Ø

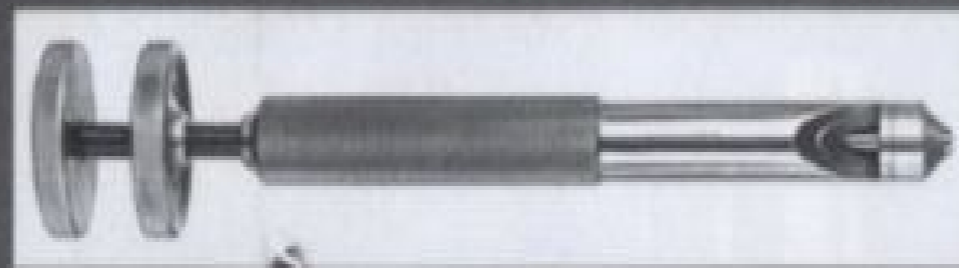

11-340-21
Loute Wire Tightener (21 cm / 8 1/4")

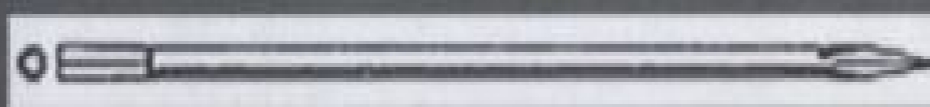

11-360-00
Steinmann Extension Pin
14 cm / 5 1/2" with trocar point
Other Measurements
A: 16 cm / 6 1/4" B: 18 cm / 7" C: 20 cm / 8"

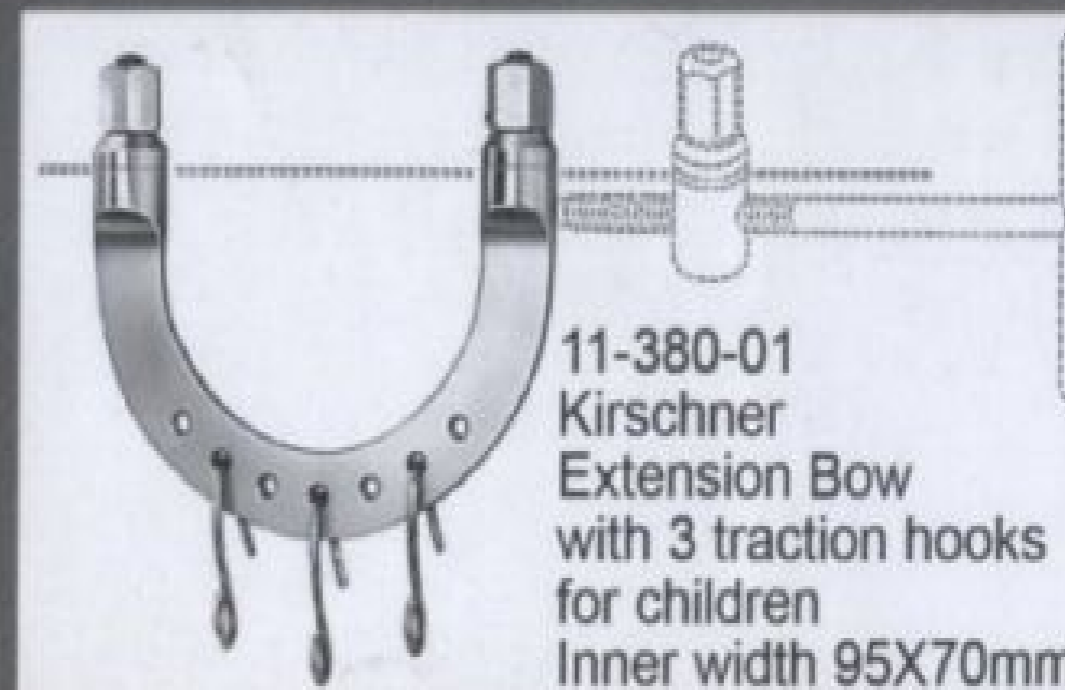

11-380-01
Kirschner
Extension Bow
with 3 traction hooks
for children
Inner width 95X70mm

Other Sizes
11-380-02
for wrist and ankle
IW:105X105mm
11-380-03
for elbow
IW:120X120mm
11-380-04
for knee
IW:155X155mm
11-380-05
for femur
IW: 200X155mm

IW stands for Inner Width

11-330-02 (A-K)
Bone Wire soft, coil of 10 m
Please add alphabetic #s with 11-330-02
when placing order

- A: 0,2 mm Ø
- B: 0,3 mm Ø
- C: 0,4 mm Ø
- D: 0,5 mm Ø
- E: 0,6 mm Ø
- F: 0,7 mm Ø
- G: 0,8 mm Ø
- H: 0,9 mm Ø
- J: 1,2 mm Ø
- I: 1,0 mm Ø
- K: 1,5 mm Ø



11-335-00
Demel
Wire Guide
31 cm / 12 1/4"

Other Sizes:

- 29 cm / 11 1/2"
- 28 cm / 11"

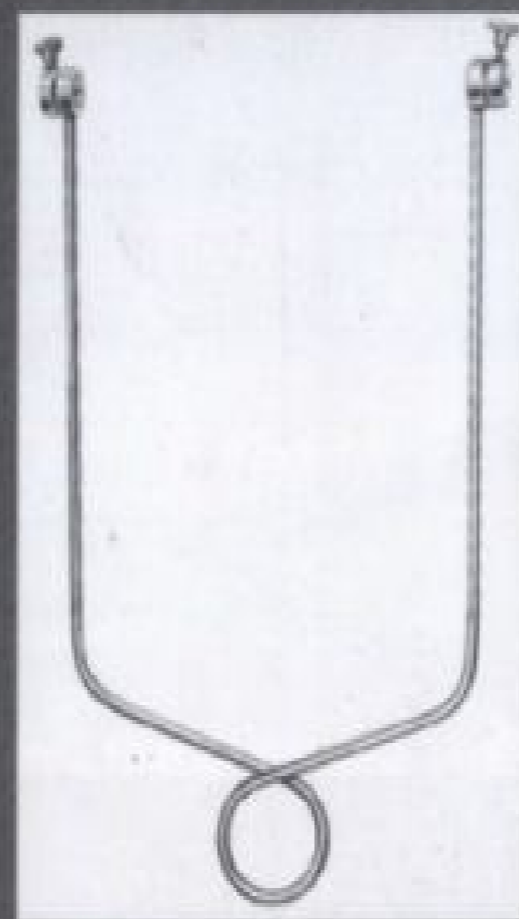

11-365-00 (8" x 6")
Böhler Extension
Bow for femur & knee
Other Measurements
A: for arm 6 1/4" x 4 1/2"
B: for femur and knee
8 1/4" x 4 1/2"

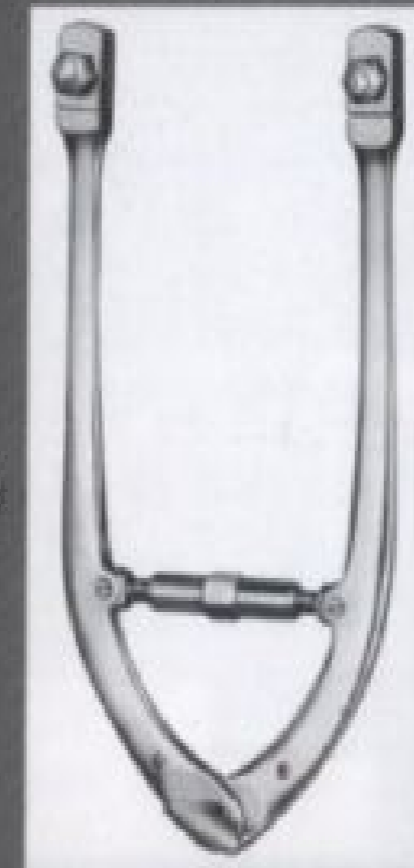

11-392-10
Extension Bow
10 1/2" X 6 1/4"

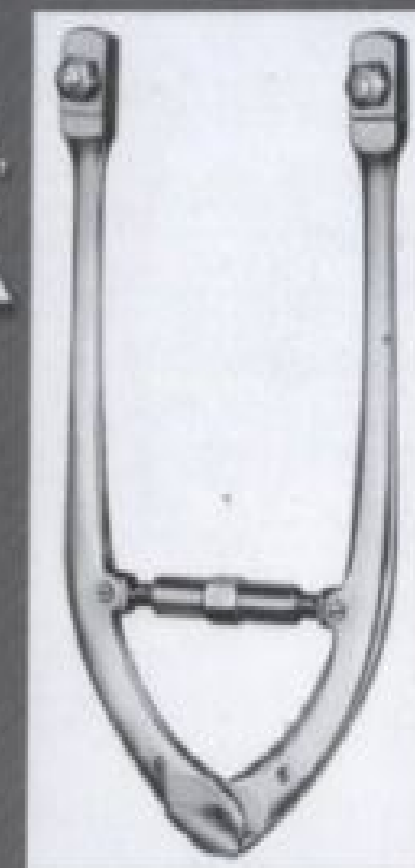

11-392-07
Extension Bow
7" X 4"

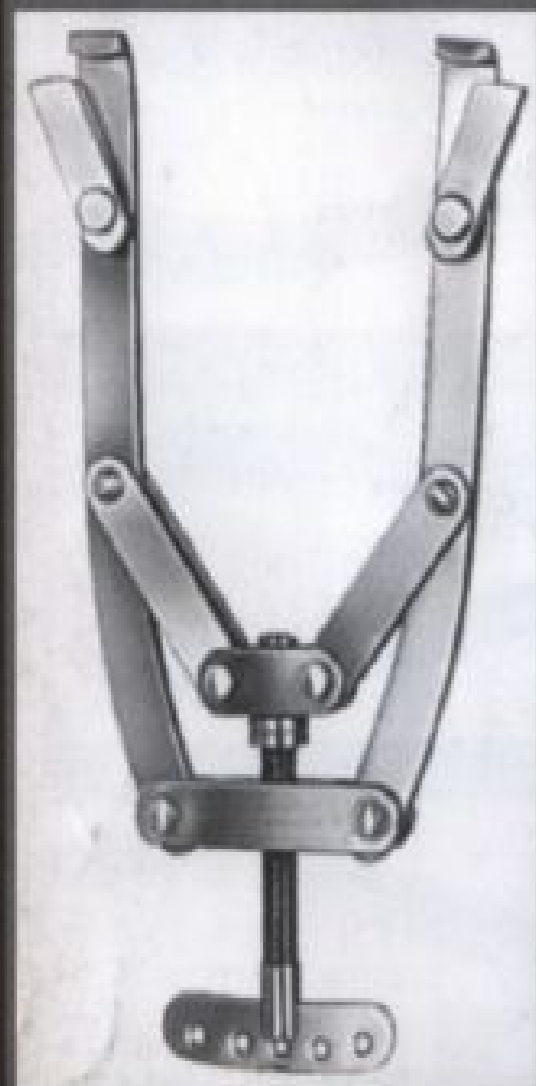

11-385-18 (Kirschner)
Extension Bow
18.5 cm / 7 1/4"
with 3 traction hooks
small pattern

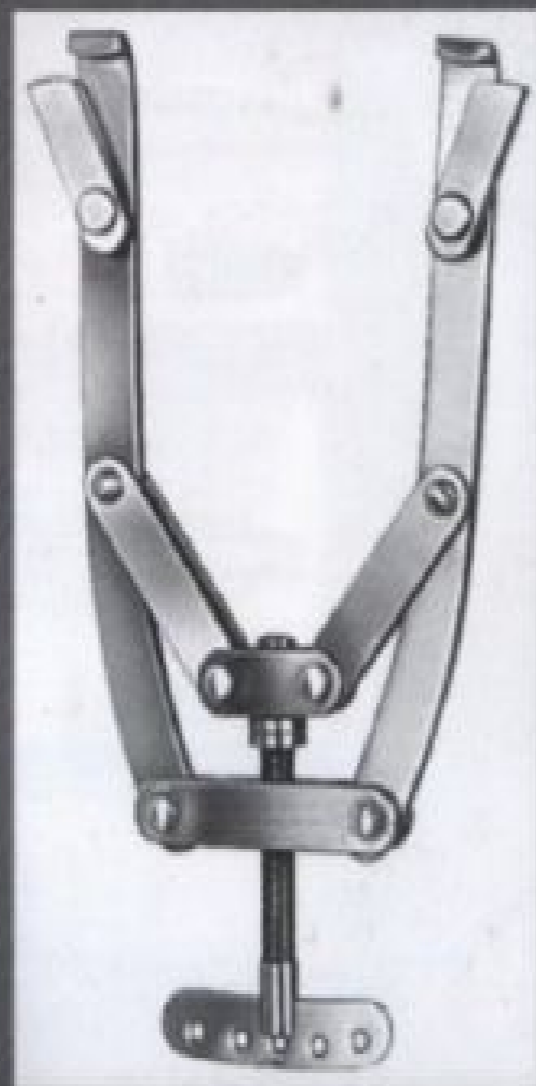

11-385-26 (Kirschner)
Extension Bow
26.5 cm / 10 1/2"
with 3 traction hooks
Large pattern

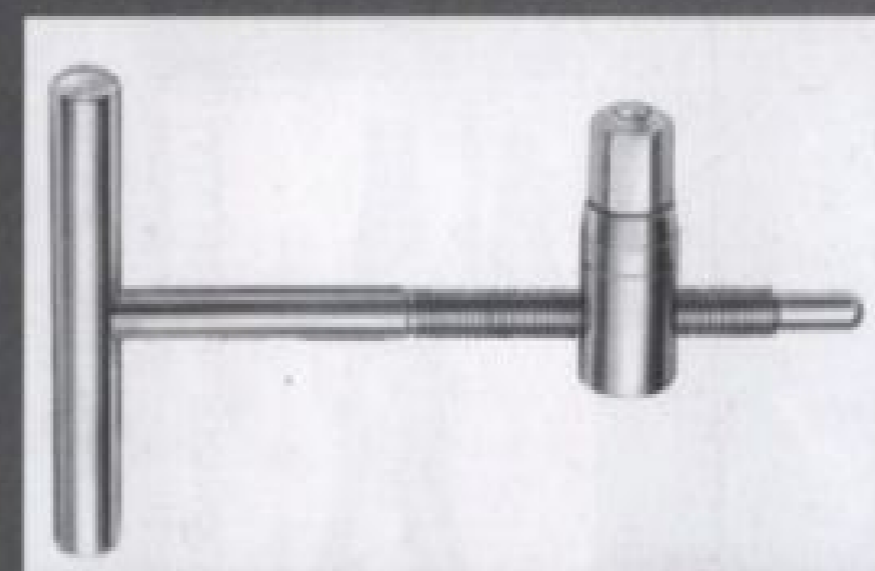

11-387-18
Wire Strainer
18.5 cm / 7 1/4"



11-390-20
Wrench 20 cm / 8"

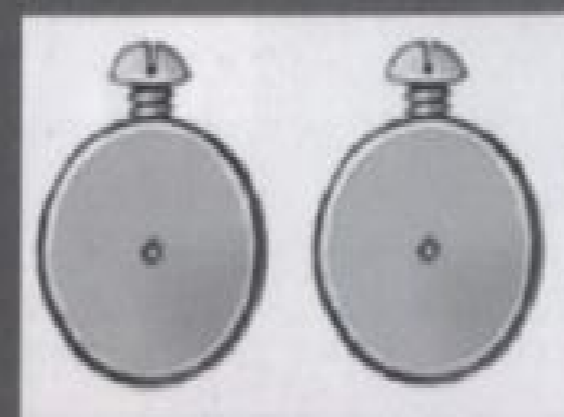

11-405-00
Fixation Discs
for wire drills, pair



11-407-00
Traction Hook
for Extension Bows

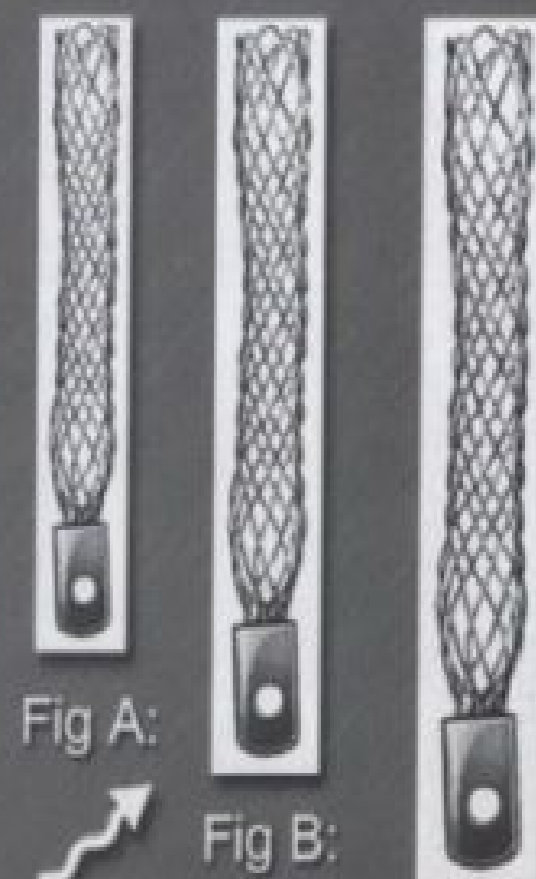

11-400-00
Extension Sleeve
wire mesh, autoclavable
Fig A: Small
Fig B: Medium
Fig C: Large

Bone Rasps_Files / Biopsy / Tamper



12-220-30
Putti Bone Rasp round / semi round 30cm/11 3/4"

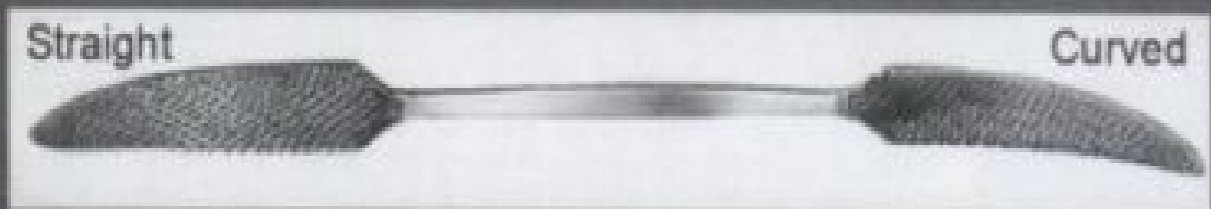

12-222-27
Putti Bone Rasp curved / straight 27cm / 10 3/4"

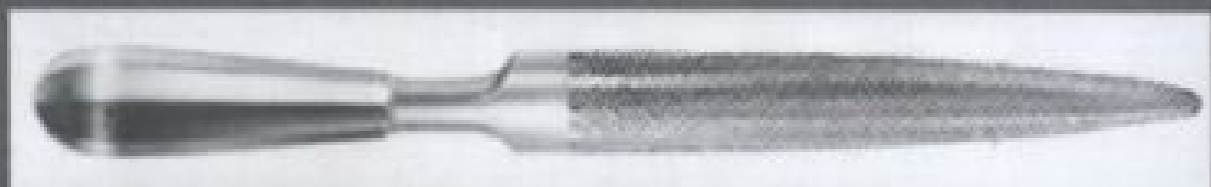

12-440-28 Bone File
28 cm/11" with hollow handle / semi round



12-441-24 Bone File
24.5 cm/9 3/4" with hollow handle/semi round



12-442-22
Bone File
22 cm / 8 3/4" solid / flat



12-446-18 A/B/C/D/E
Miller-Colburn Bone File
18 cm / 7" downwards cutting
Pls add required type / size when inquire.

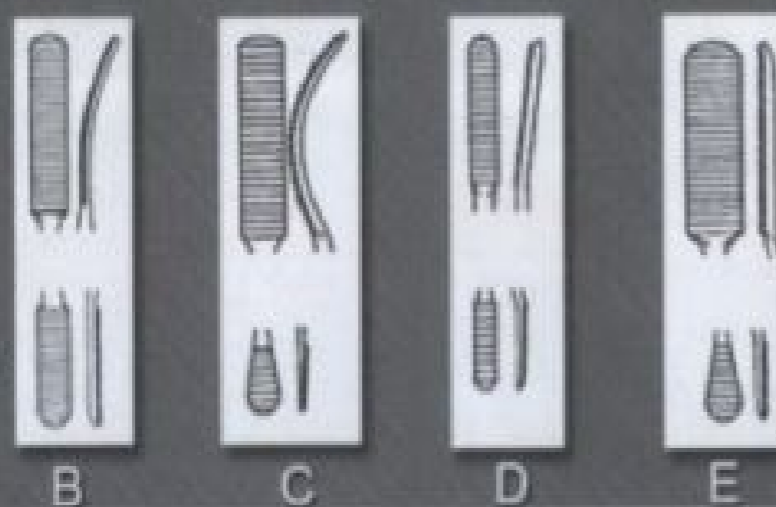

12-230-22
Champy-OSU 22 cm / 8 3/4"
Bone Biopsy Instrument

Consisting of trocar, a toothed trephine and a plunger for taking tibial and iliac bone grafts through a closed technique

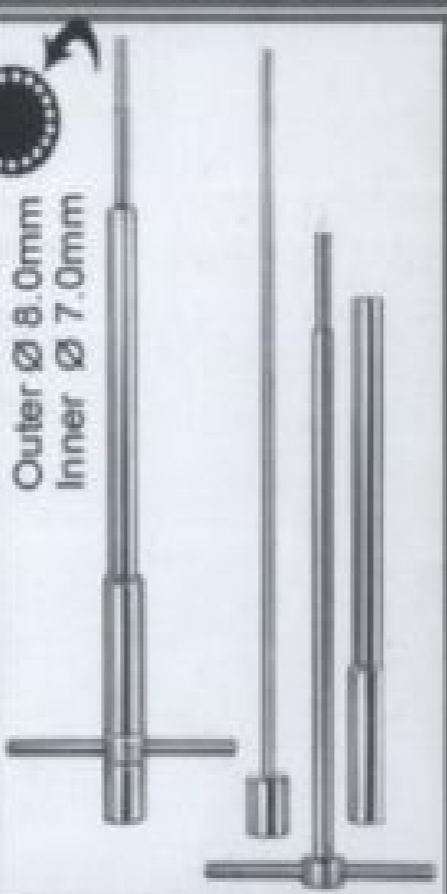

12-231-22
Champy Bone Biopsy Instrument 22cm/8 3/4"
12-232-22 (22cm/8 3/4")
Outer Ø 5.0mm
Inner Ø 4.0mm

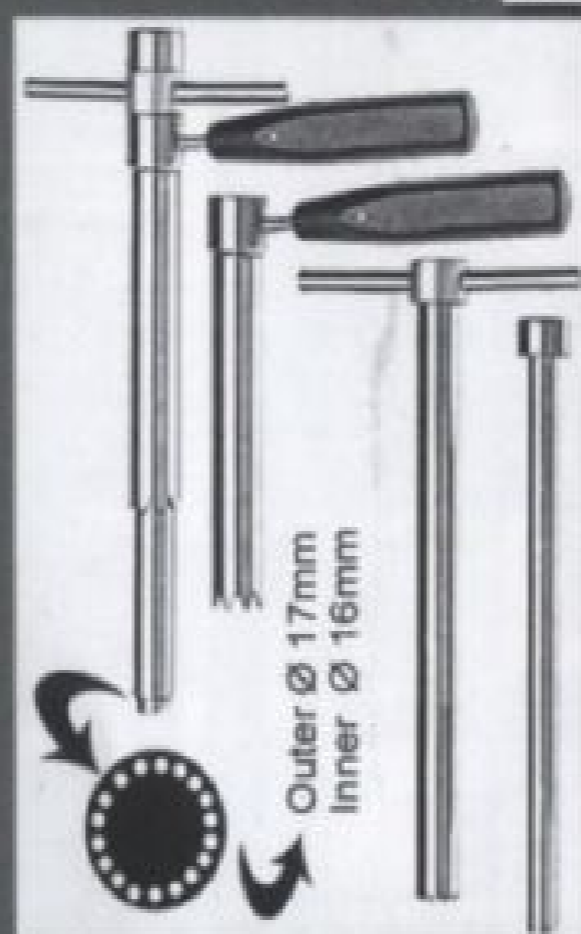

12-234-22
Champy Cancellous Bonegraft Mill
22.5 cm / 8 3/4"

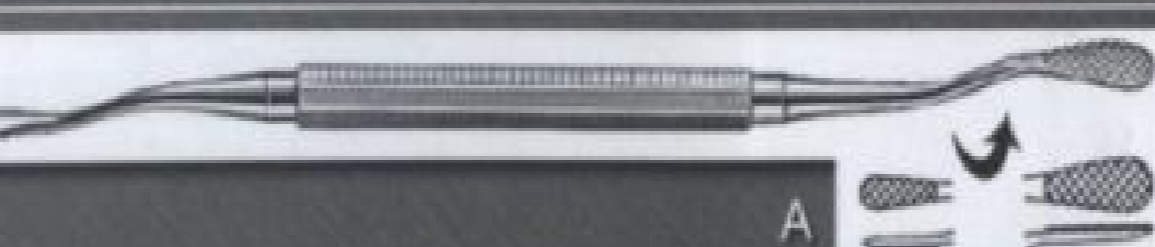

12-447-18 A/B/C/D
Miller-Colburn Bone File
18 cm / 7" Cross Cut
Pls add required type / size when inquire.

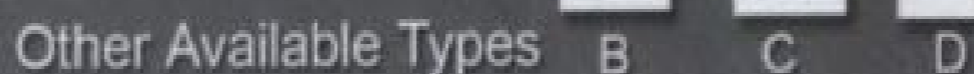

12-250-15
Tamper
15.5 cm / 6"
Tip Sizes available
2mm Ø / 3mm Ø
4mm Ø / 5mm Ø
6mm Ø / 8mm Ø
10mm Ø

Bone Levers

Front / Side View



12-470-16 Bone Lever 16 cm / 6 1/4"



12-471-16 Hohman, Mini Bone Lever
16 cm/6 1/4" 6mm tip



12-472-16 Hohman, Mini Bone Lever
16 cm / 6 1/4" 8 mm tip



12-473-16 Hohman, Mini Bone Lever
16 cm / 6 1/4" 14 mm tip

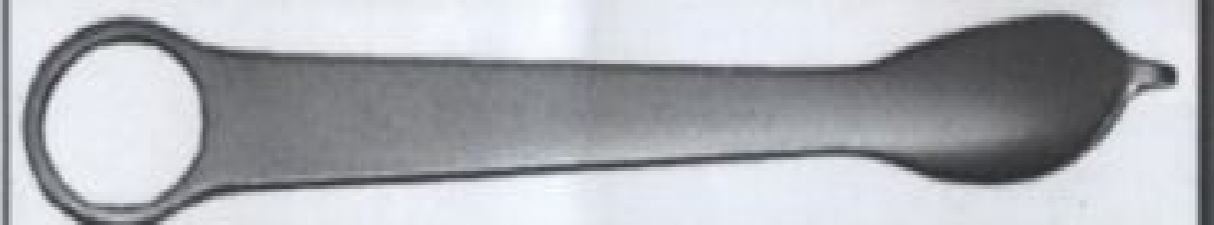

12-474-12 Hohman, Mini Bone Lever
12 cm / 4 3/4" 14 mm tip

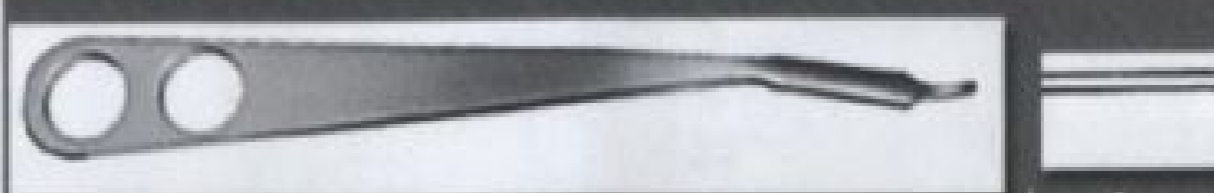

12-476-22 Hohmann Bone Lever
22 cm / 8 3/4" 8 mm Tip narrow tip

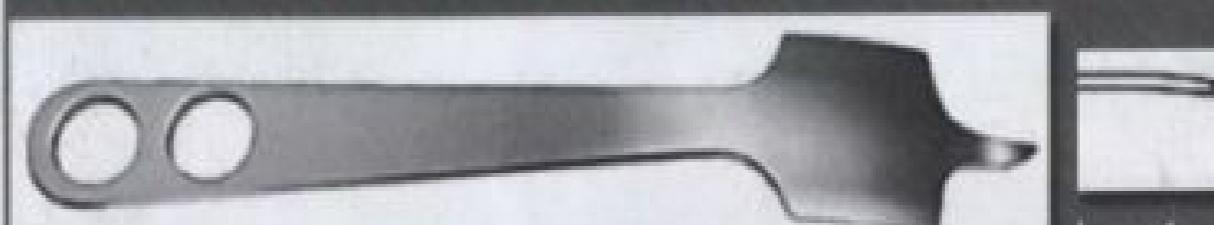

12-477-23 Hohmann Bone Lever
23.5 cm / 9 1/4" 43 mm Tip narrow tip

Bone Levers and Retractors

12-477-25



Hohmann Bone Lever 25 cm / 9 3/4" 70 mm Tip narrow tip

12-478-23

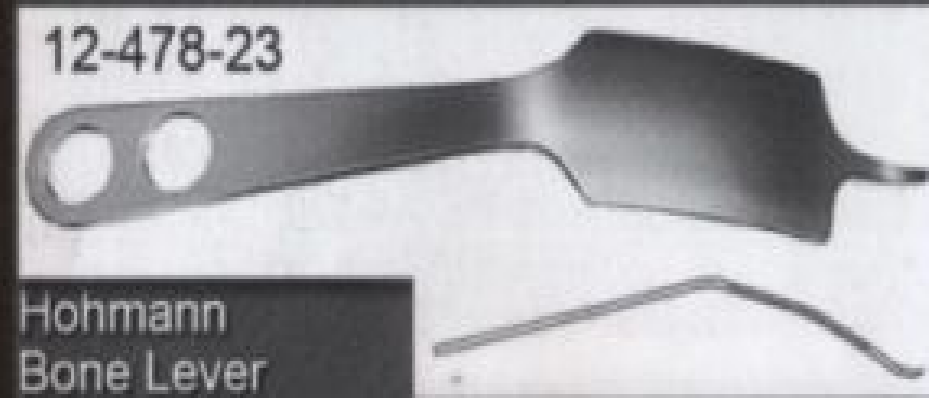

Hohmann Bone Lever 23.5 cm / 9 1/4" 43mm Tip narrow tip

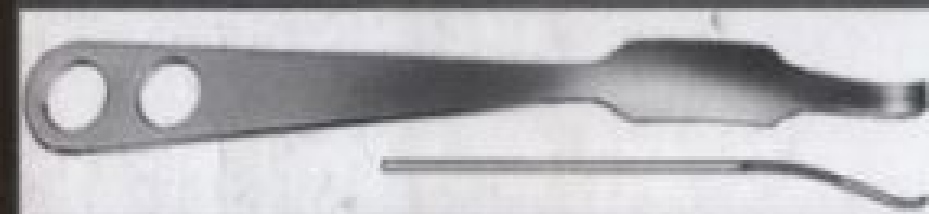

12-479-25 Hohmann Bone Lever 25.5 cm / 10" 22mm Tip wide tip



12-479-29 Hohmann Bone Lever 29 cm / 11 1/2" 35mm Tip wide tip

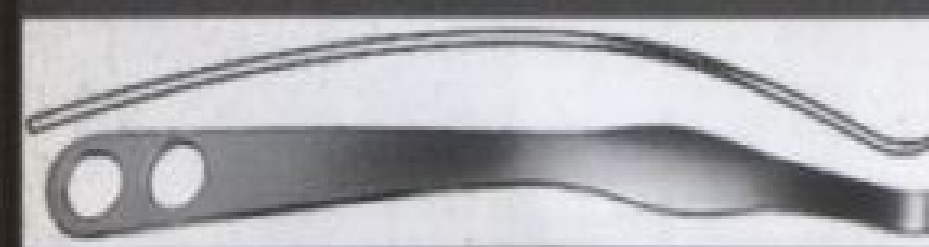

12-480-27 Hohmann Bone Lever 27.5 cm / 10 3/4" 24mm Tip wide, round tip



12-481-25 Lange-Hohmann Bone Lever 25 cm / 9 3/4" 22mm Tip wide tip with groove

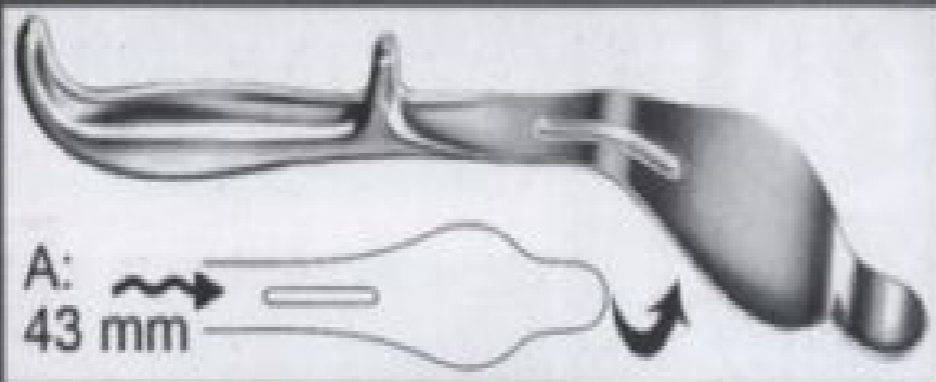

12-484-24 A / B Bennett Bone Lever 24 cm / 9 1/2"

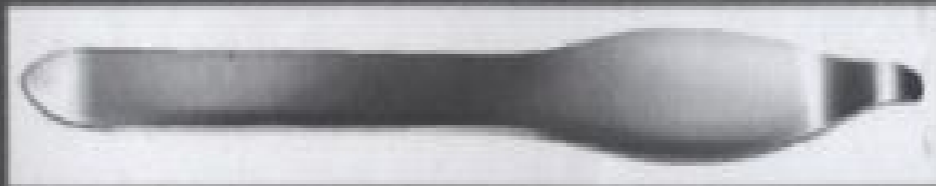
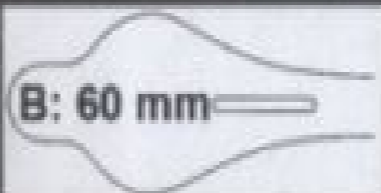

12-488-26 Blount Knee Retractor 26.5 cm / 10 1/2" blunt



12-489-26 Blount Knee Retractor 26.5 cm / 10 1/2"



12-490-17 Blount Knee Retractor 17.5 cm / 7"



Sizes Available
A: 75X30mm
B: 100X30mm

12-491-16 A / B Taylor Spinal Retractor 16 cm / 6 1/4" pointed end

Chisels / Gouges / Osteotomes

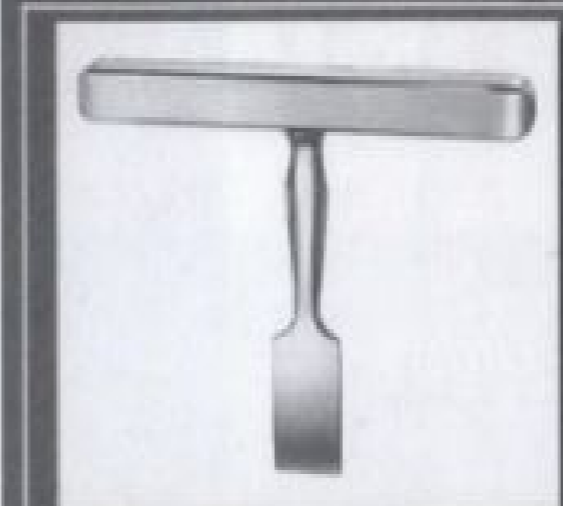

12-100-7 (7.5 cm/3") Virchow Skull Breaker



12-122-16 Snyder-O.S.U Bone Chisel 16.5 cm / 6 1/2" 3 mm / 5 mm



12-124-17 O.S.U. Bone Chisel 17 cm / 6 3/4" 7mm

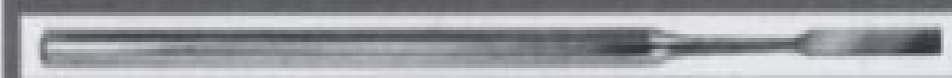
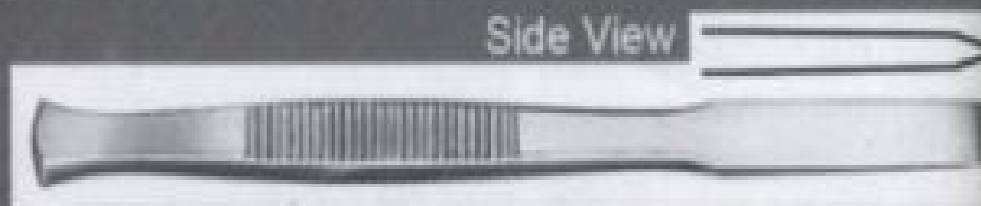

12-110-16 Buckley Chisel 16 cm / 6 1/4" octagonal handle



12-110-17 Buckley Gouge 16 cm / 6 1/4" octagonal handle

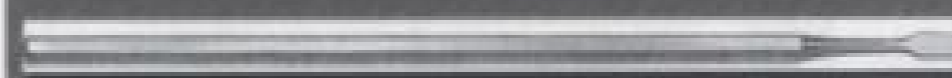

12-112-21 Stout Bone Chisel 21 cm / 8 1/4" octagonal handle



12-115-18 Bone Chisel 18 cm / 7" Round handle



12-115-19 4mm 17 cm / 6 3/4"

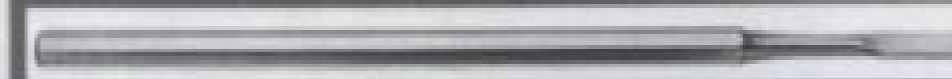
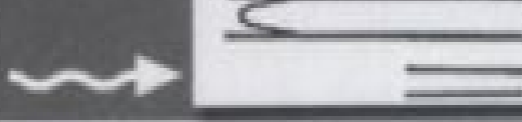

12-116-18 Bone Chisel 18 cm / 7" octagonal handle



12-118-17 Gardner Bone Chisel 17 cm / 6 3/4" 4mm

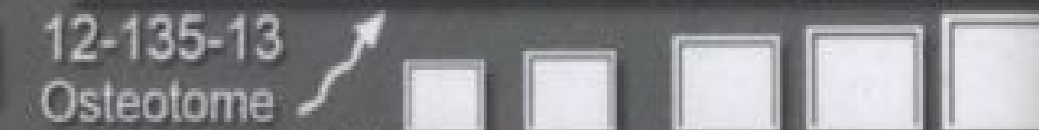
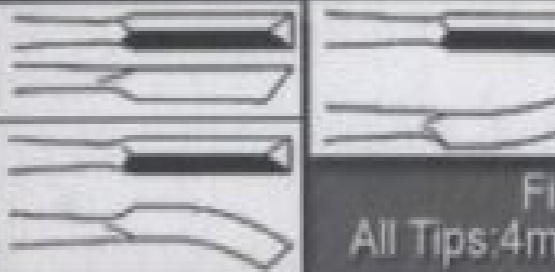

12-135-13 Osteotome 13.5 cm / 5 1/4"

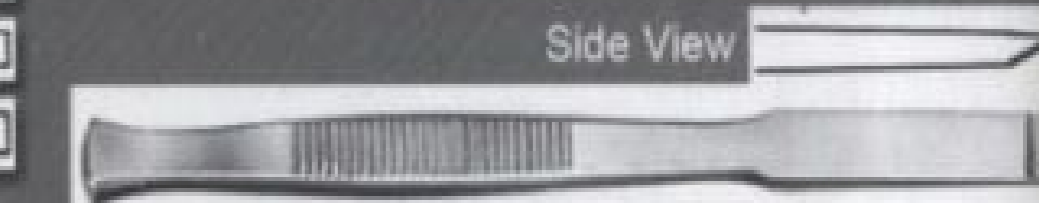

12-137-13 Chisel 13.5 cm / 5 1/4"



12-140-13 Gouge 13.5 cm / 5 1/4"

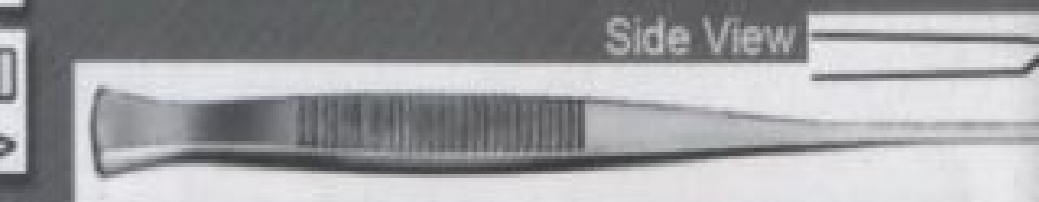

12-145-13 Partsch Chisel 13.5 cm / 5 1/4" & 17cm / 6 3/4"

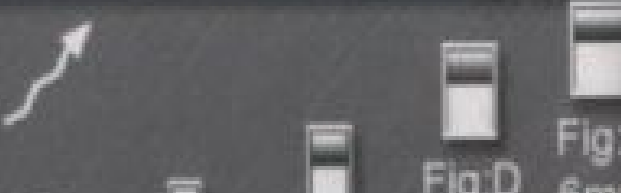

Chisels / Gouges / Osteotomes



12-147-13 Partsch Gouge
13.5 cm / 5 1/4" & 17 cm / 6 3/4"

Fig. A: 2mm
Fig. B: 3mm
Fig. C: 4mm
Fig. D: 5mm
Fig. E: 6mm

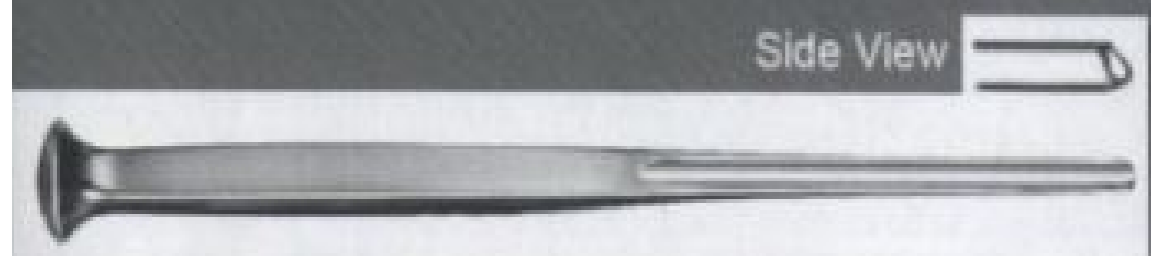

12-155-17 Alexander Gouge
17.5 cm / 7"

A: 4mm B: 6mm C: 8mm D: 10mm E: 12mm F: 14mm

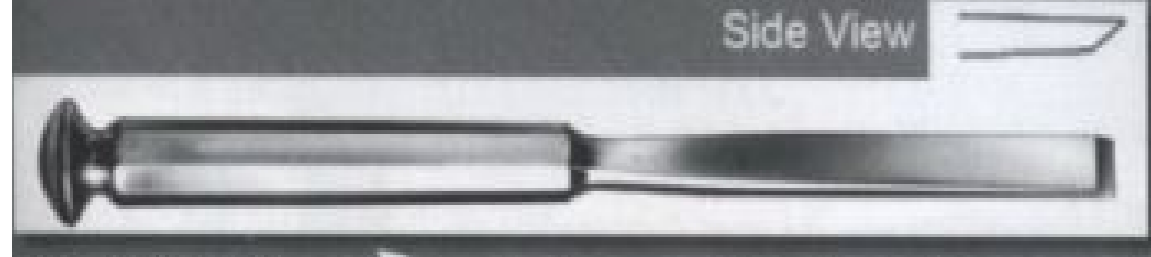

12-160-20 Stille Chisel
20 cm / 8"

A: 10mm B: 15mm C: 20mm D: 25mm

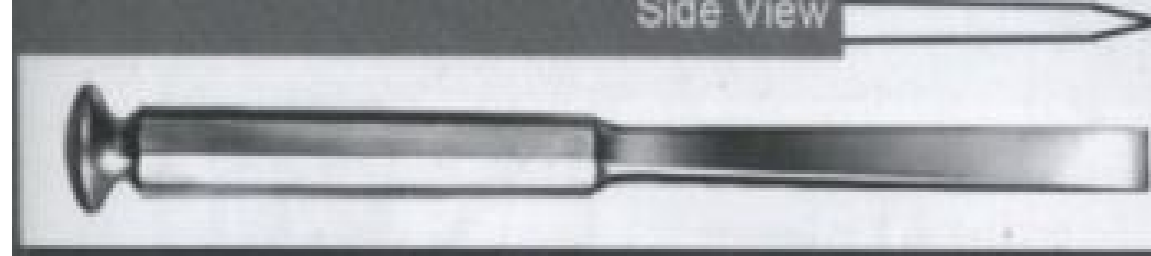

12-162-20 Stille Osteotome
20 cm / 8"

A: 10mm B: 15mm C: 20mm D: 25mm



12-165-20 Stille Gouge
20 cm / 8"

A: 10mm B: 15mm C: 20mm D: 25mm

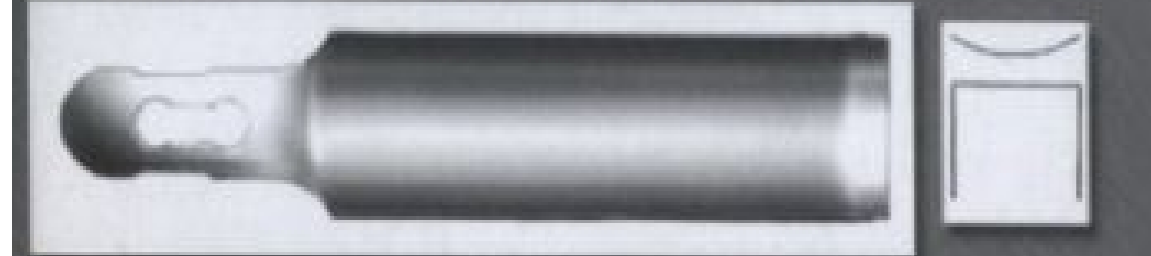

12-170-13 Gouge Blade
13.5 cm / 5 1/4"

Available interchangeable 25mm RADIUS sizes
r = 50mm / 60mm / 70mm



12-172-18 Chisel Handle 18.5 cm / 7 1/4"

Handle, only Pts see art# 12-172-19 for chisel / osteotome blades (sizes) And see art# 12-172-20 for spare screw and key

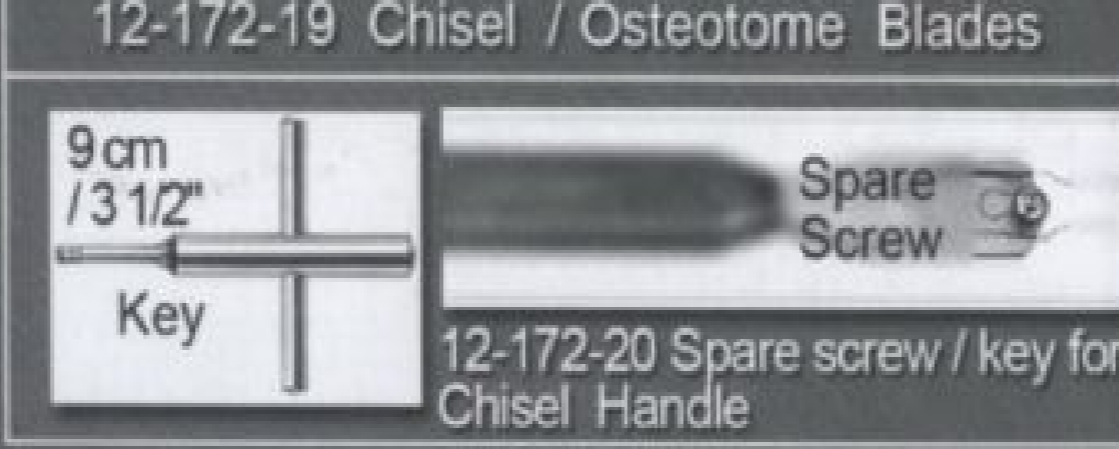
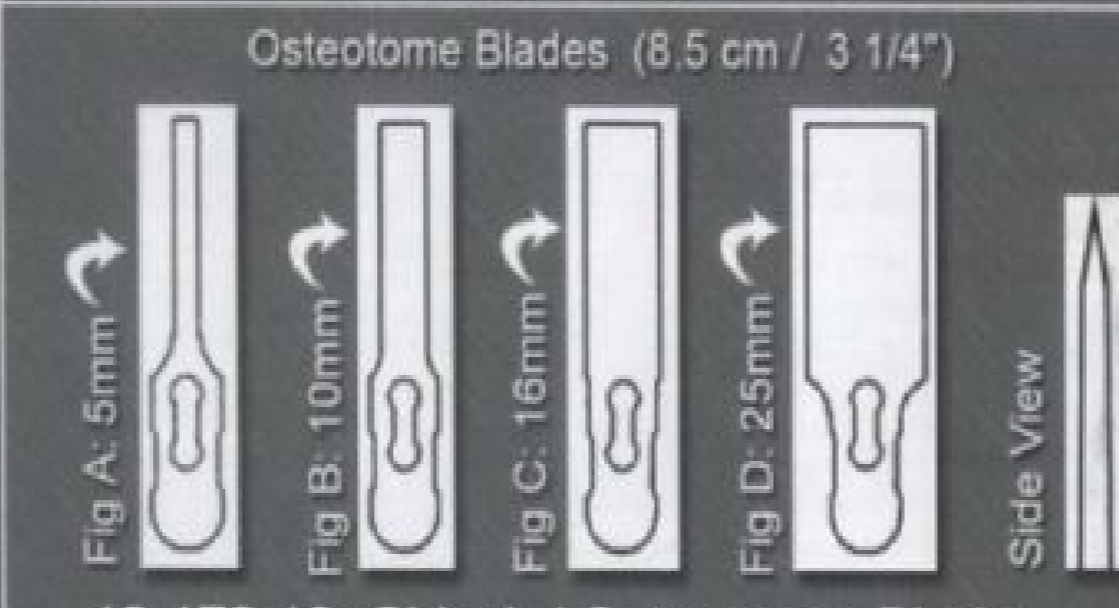
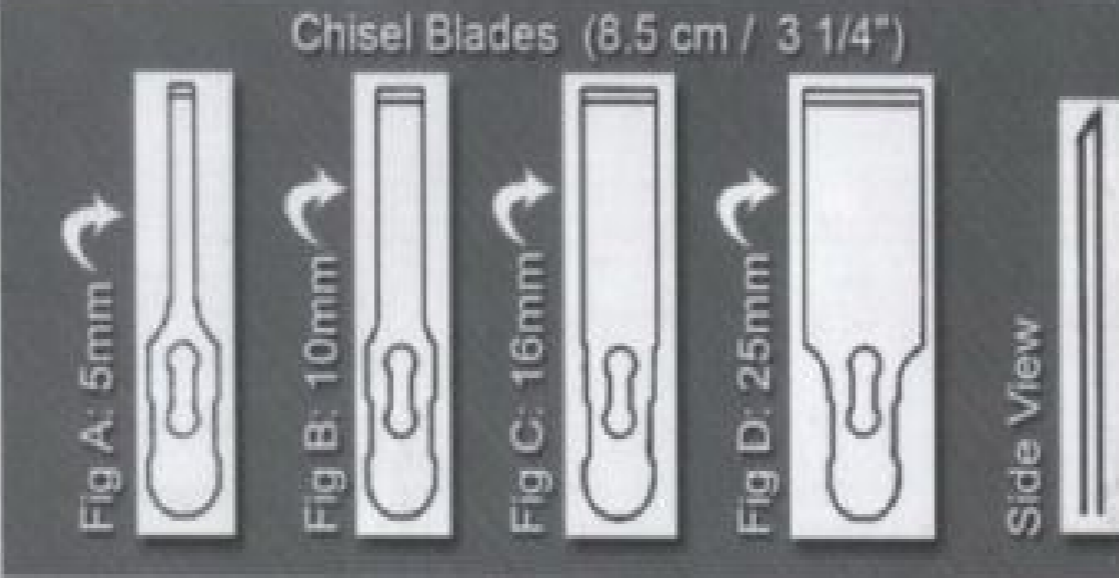

12-174-25 (25 cm / 9 3/4")
Lexer Spongiosa Gouge

C: 15mm

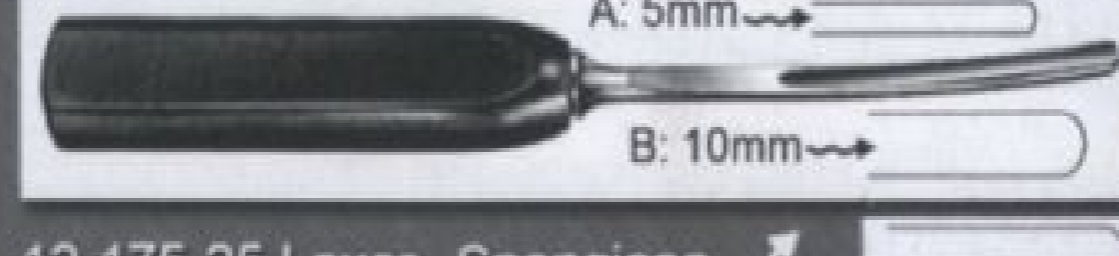

12-175-25 Lexer Spongiosa Gouge
25 cm / 9 3/4"

C: 15mm



12-178-18 Lexer, Mini Osteotome
18.5 cm / 7 1/4"

A: 4mm B: 6mm C: 8mm D: 10mm E: 12mm



12-180-18 Lexer, Mini Gouge
18.5 cm / 7 1/4"

A: 4mm B: 6mm C: 8mm D: 10mm E: 12mm



12-182-22 Lexer, Osteotome
22 cm / 8 3/4"

A: 7mm B: 10mm C: 15mm D: 20mm E: 25mm F: 30mm



12-184-22 Lexer, Gouge
22 cm / 8 3/4"

A: 7mm B: 10mm C: 15mm D: 20mm E: 25mm F: 30mm



12-186-12 (12.5 cm / 5")
Lambotte, Mini Osteotome

12-186-17 (17 cm / 6 3/4")
Lambotte, Mini Osteotome

3mm / 4mm / 6mm / 8mm / 10mm / 12mm / 15mm

12-186-24 (24 cm / 9 1/2")
Lambotte, Osteotome

15mm / 20mm / 25mm / 30mm / 38mm / 44mm / 50mm

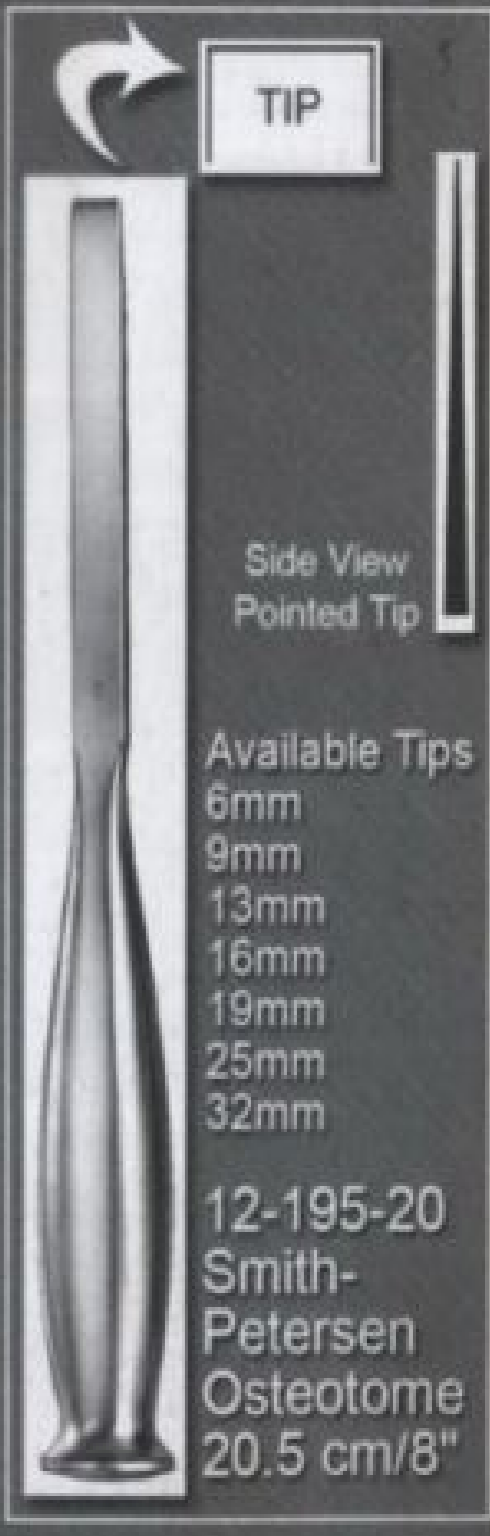

Other Lambotte Mini Osteotomes sizes / Tips

For Image, please see photo of above Osteotome.

Chisels / Gouges / Osteotomes

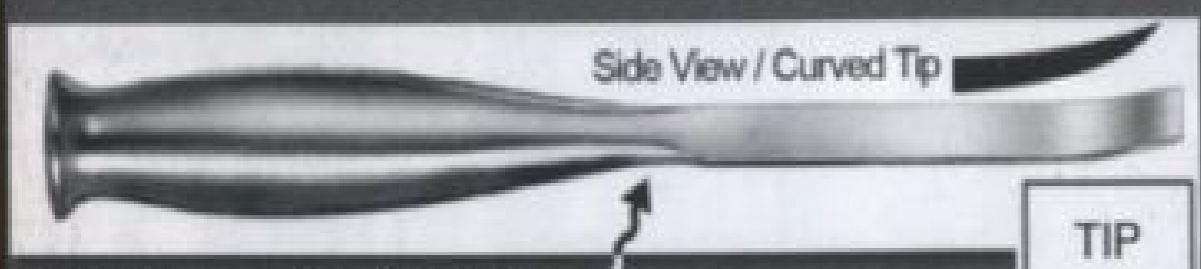

12-196-20 Smith-Petersen Osteotome
20.5 cm / 8"
6mm / 9mm / 13mm / 16mm / 19mm / 25mm / 32mm



12-198-20 Smith-Petersen Gouge
20.5 cm / 8"



12-199-20 Smith-Petersen Gouge
20.5 cm / 8"

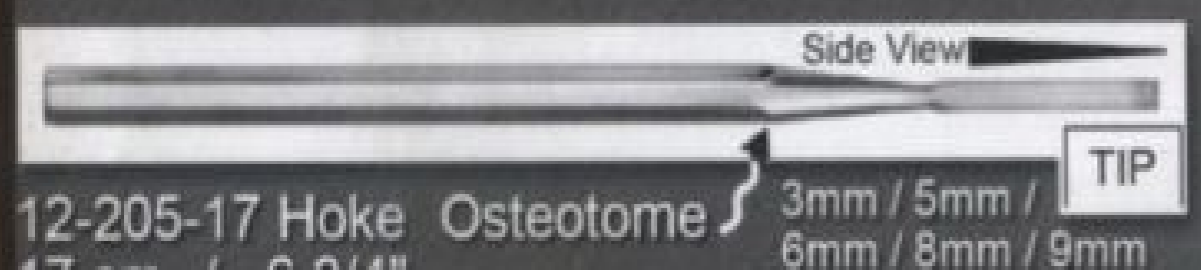

12-205-17 Hoke Osteotome
17 cm / 6 3/4"

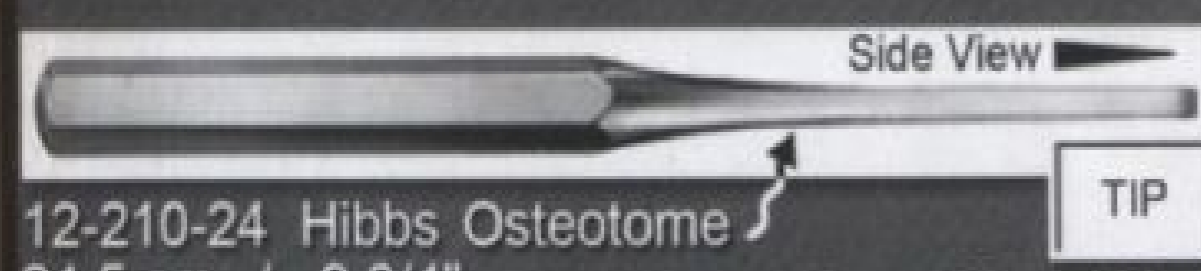

12-210-24 Hibbs Osteotome
24.5 cm / 9 3/4"



12-211-24 Hibbs Chisel
24.5 cm / 9 3/4"



12-212-24 Hibbs Gouge
24.5 cm / 9 3/4"



Bone Curettes



12-330-18 (18.5 cm / 7 1/4") Volkman Bone Curette
oval with plastic handle

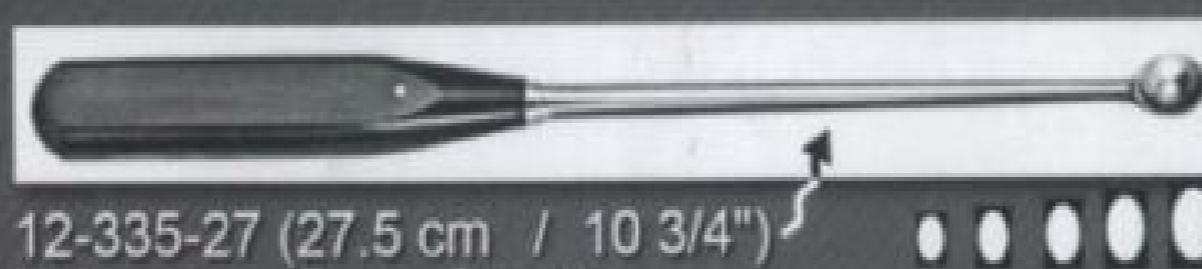

12-335-27 (27.5 cm / 10 3/4") Volkman Bone Curette
oval with plastic handle

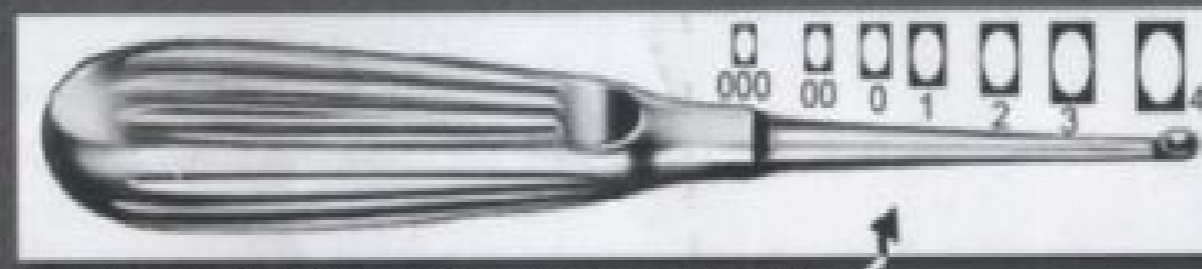

12-340-17 Schede Bone Curette
17 cm / 6 3/4" oval with hollow handle

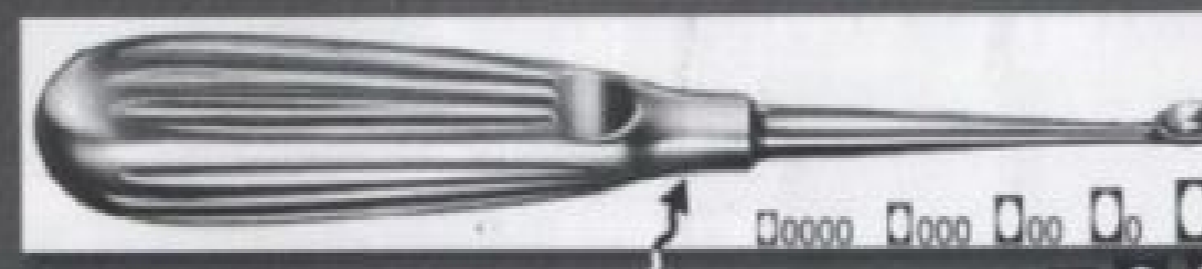

12-342-17 Volkman Bone Curette
17 cm / 6 3/4" oval, with hollow handle



12-344-17 Bruns Bone Curette
17 cm / 6 3/4" Round, with hollow handle

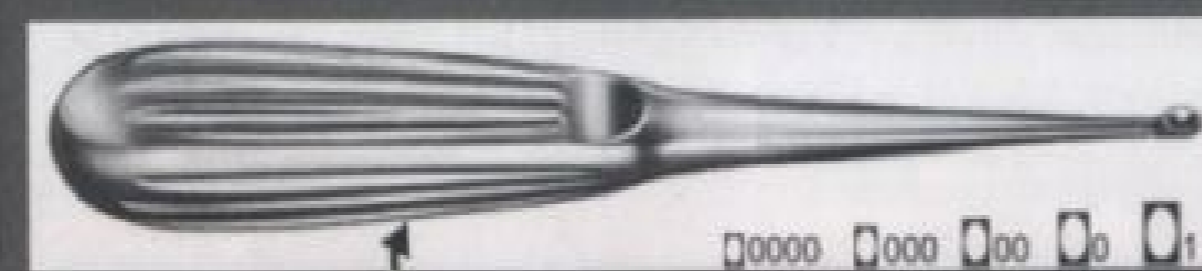

12-346-17 Spratt Bone Curette
17 cm / 6 3/4" Oval, with hollow handle

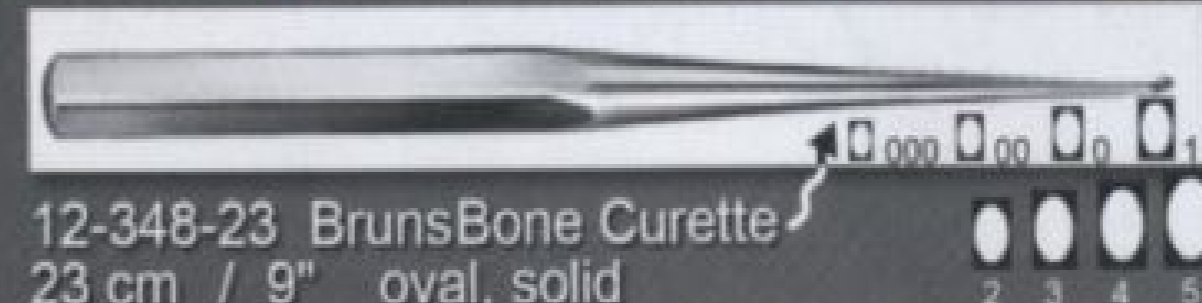

12-348-23 Bruns Bone Curette
23 cm / 9" oval, solid

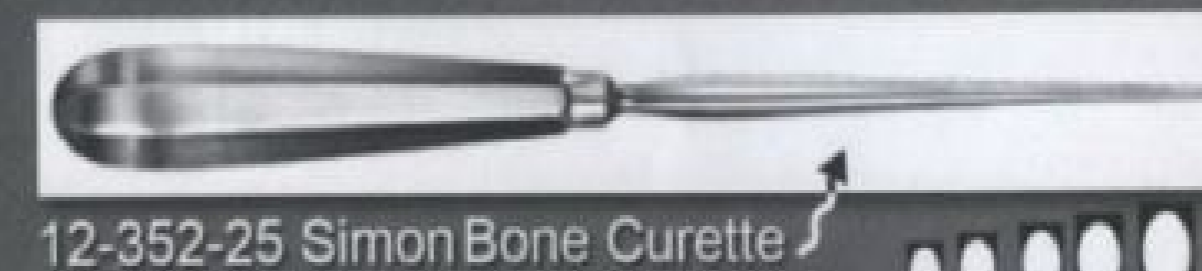
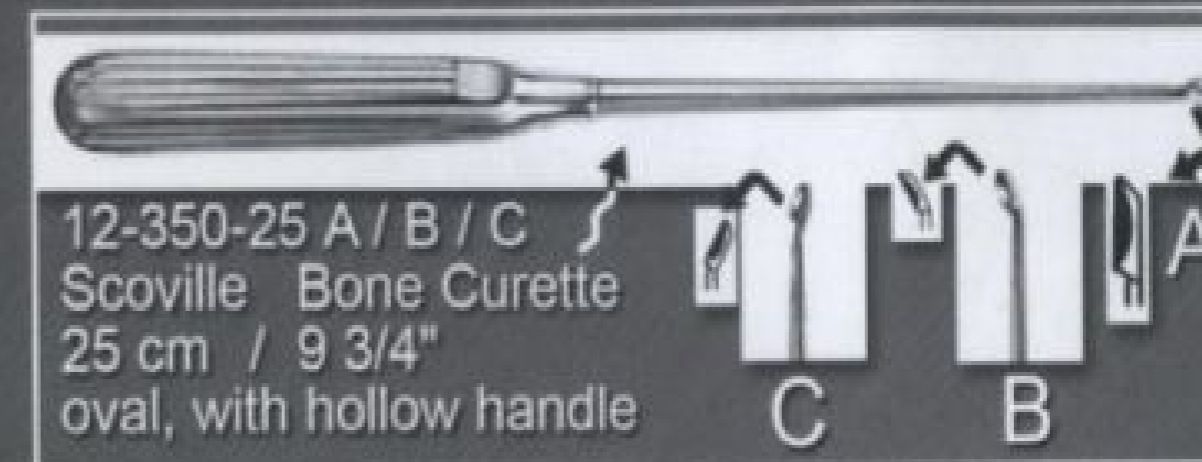

12-352-25 Simon Bone Curette
25 cm / 9 3/4" oval, with hollow handle

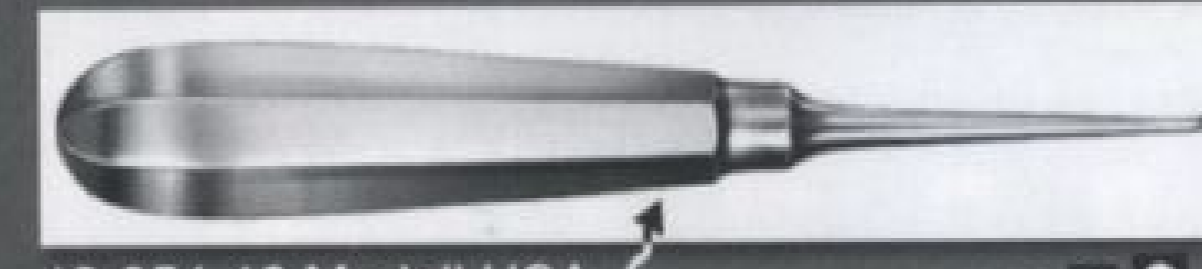

12-354-16 Modell USA Bone Curette
16 cm / 6 1/4" Oval, with hollow handle



12-356-15 Modell USA Bone Curette
15.5 cm / 6" Oval, with hollow handle



12-357-15 Modell USA Bone Curette
15.5 cm / 6" Oval, with hollow handle

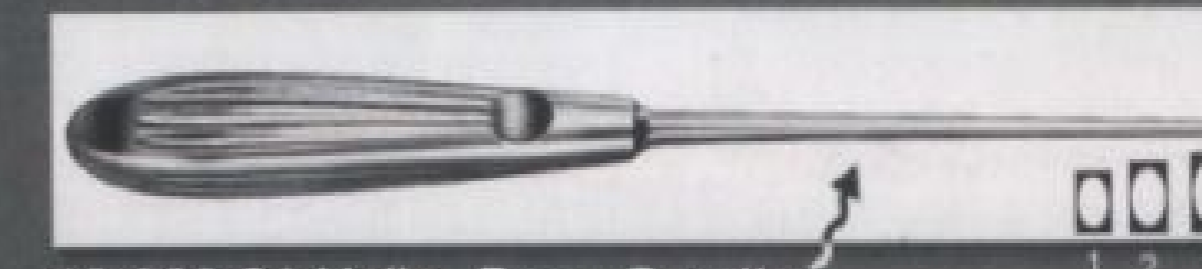

12-360-21 Halle Bone Curette
21 cm / 8 1/4" oval, malleable shaft, with hollow handle

Available in 3 sizes (Length)
A: 12.5 cm / 5"
B: 14.5 cm / 5 3/4"
C: 17 cm / 6 3/4"

23-364-12 A / B / C Volkman Bone Curette, double-ended

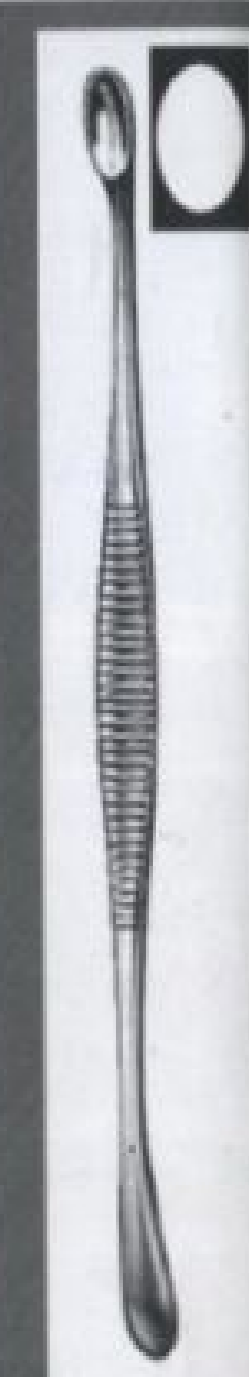

Bone Curettes

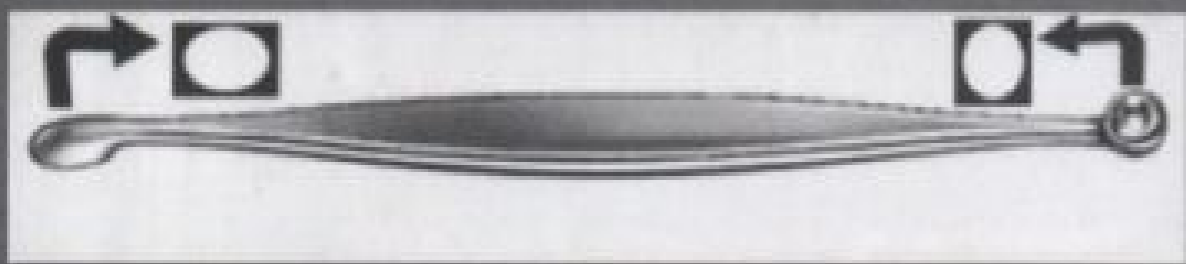

12-366-13 A / B / C Available in 3 sizes (Length)
 Volkmann Bone Curette, double-ended (oval / round)
 A: 13 cm / 5"
 B: 16 cm / 6 1/4"
 C: 20 cm / 8"

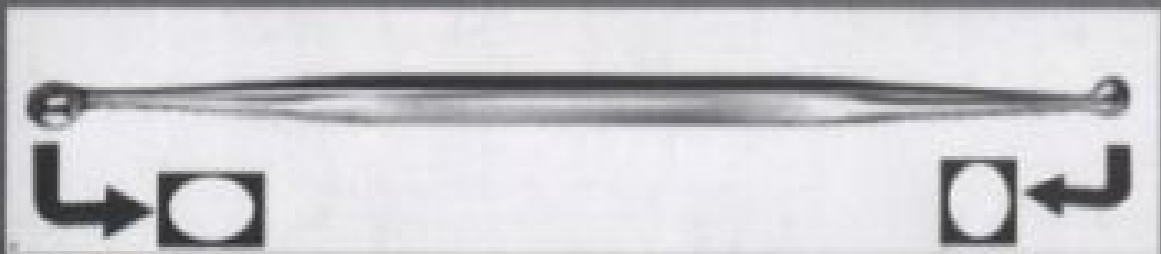

12-368-21 Bone Curette, double-ended (round / oval) 21 cm / 8 1/4"

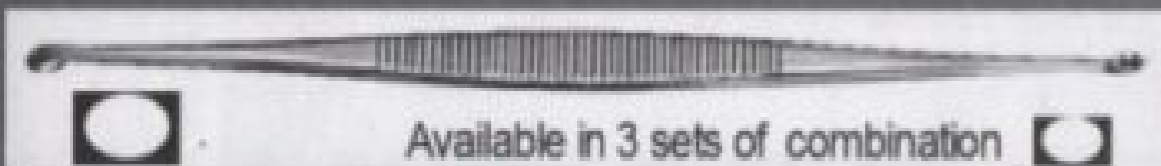

Available in 3 sets of combination
 12-370-13 A / B / C Williger Bone Curette, double-ended 13.5 cm / 5 1/4"
 A: 00/0
 B: 0/1
 C: 1/2

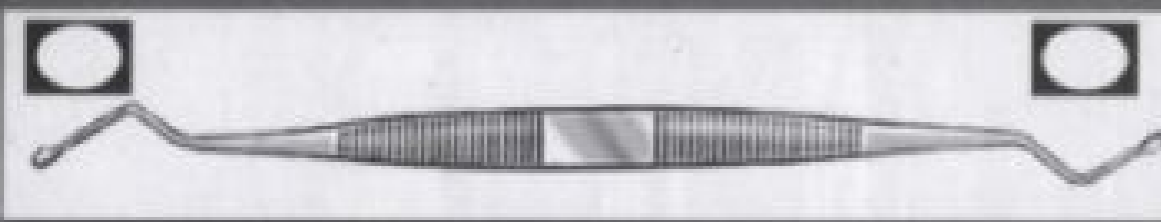

12-371-17 A / B / C Williger Bone Curette, 17 cm / 6 3/4" double-ended oval / oval
 A: 00/0
 B: 0/0
 C: 1/1

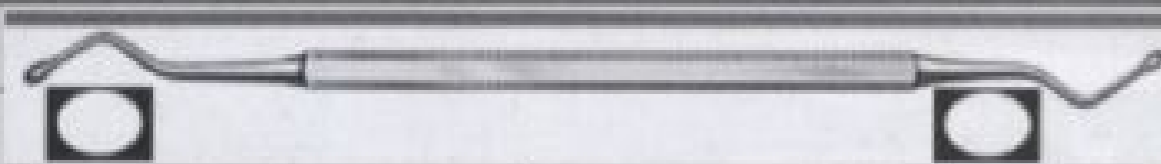

12-374-18 A / B / C Available in 3 sets of same order faces
 Hemingway-Martin Bone Curette, double-ended 18.5 cm / 7 1/4" octagonal handle oval / oval
 A: 1 R/L
 B: 2 R/L
 C: 3 R/L

For 18cm: 12-375-18 A / B / C (3 same order sets)
 Hemingway Bone Curette, double-ended 18 cm / 7" octagonal handle oval / oval (For illustration see 12-374-18)

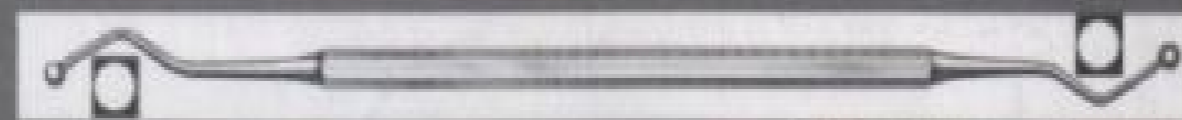

12-376-18 A / B / C Hemingway Bone Curette, double-ended, round / round 18.5 cm / 7 1/4" octagonal handle
 Available in 3 sets of same order faces
 A: 00/0
 B: 0/0
 C: 1/1



12-378-17 (17.5 cm / 7") Bone Curette, double-ended round

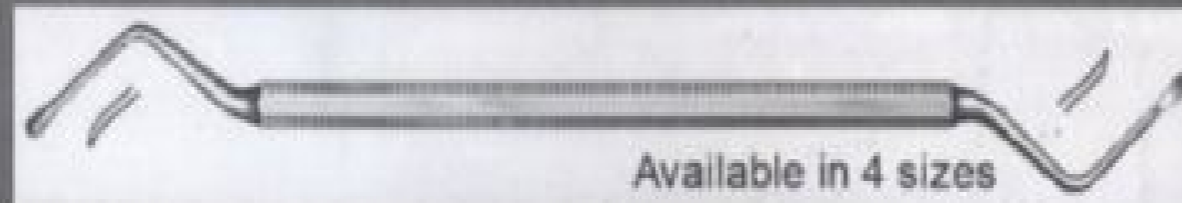

Available in 4 sizes
 12-380-18 A / B / C / D Lucas Bone Curette, double-ended 18 cm / 7" octagonal handle
 A: 1 R/L
 B: 2 R/L
 C: 3 R/L
 D: 4 R/L

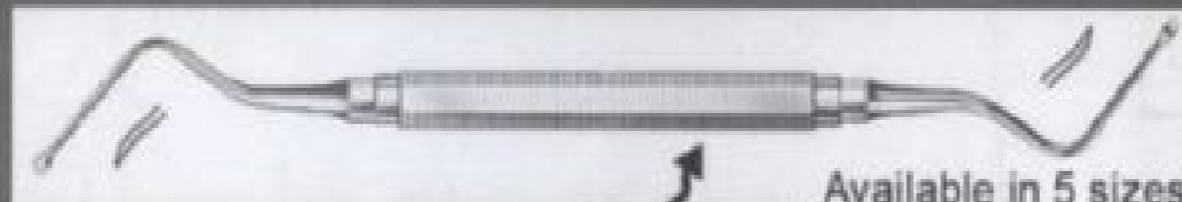

Available in 5 sizes
 12-382-17 A / B / C / D / E Miller-Colburn Bone Curette, double-ended 17 cm / 6 3/4"
 A
 B
 C
 D
 E



Available in 5 sizes
 12-384-17 A / B / C / D / E Molt Bone Curette 17 cm / 6 3/4"
 A B C D E

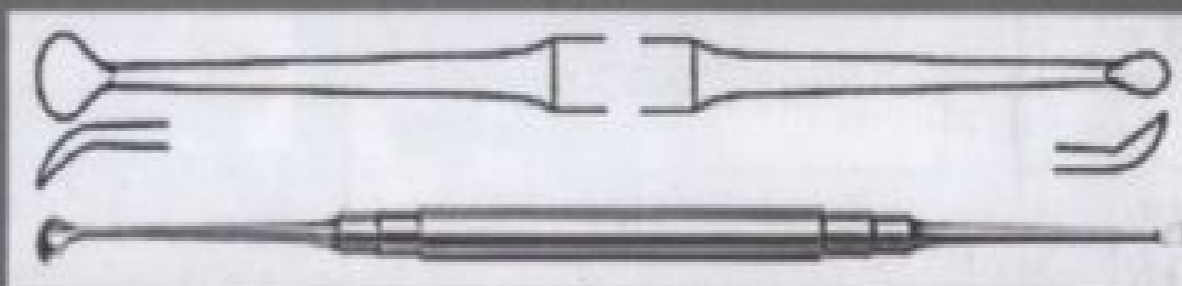

12-385-17 Molt Bone Curette 19 cm / 7 1/2" Round Handle

Elevators / Dissectors



12-388-19 A / B / C / D / E Martin-Langenbeck Periosteal Elevator (Solid)
 A: 17cm / 6 3/4" 8mm tip
 B: 19cm / 7 1/2" 16mm tip
 C: 19cm / 7 1/2" 20mm tip
 D: 18.5cm / 7 1/4" 12mm tip
 E: 18.5cm / 7" 12mm tip



12-389-16 A / B / C Martin-Langenbeck Periosteal Elevator (Solid)
 A: 16cm / 6 1/4" 7mm tip
 B: 18.5cm / 7 1/4" 15mm tip
 C: 19cm / 7 1/2" 20mm tip



12-390-17 A / B / C / D Martin-Langenbeck Periosteal Elevator (Solid)
 A: 17.5cm / 7" 4mm tip
 B: 17.5cm / 7" 5mm tip
 C: 19.5cm / 7 3/4" 6mm tip
 C: 19.5cm / 7 3/4" 7mm tip

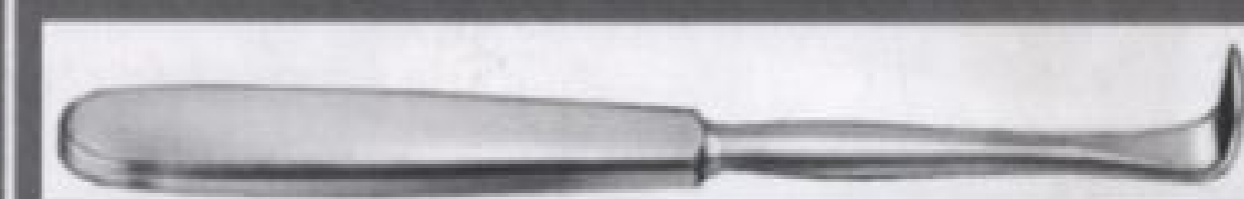

12-392-18 Langenbeck Periosteal Elevator 18.5 cm / 7 1/4" with hollow handle



12-394-19 Langenbeck Periosteal Elevator 19.5 cm / 7 3/4" with hollow handle



12-396-16 Periosteal Elevator 16 cm / 6 1/4" Delicate, solid
 Side View
 5mm
 6mm
 7mm



12-398-15 Farabeuf Periosteal Elevator 15 cm / 6" with hollow handle
 Side/ Front View

Elevators / Dissectors

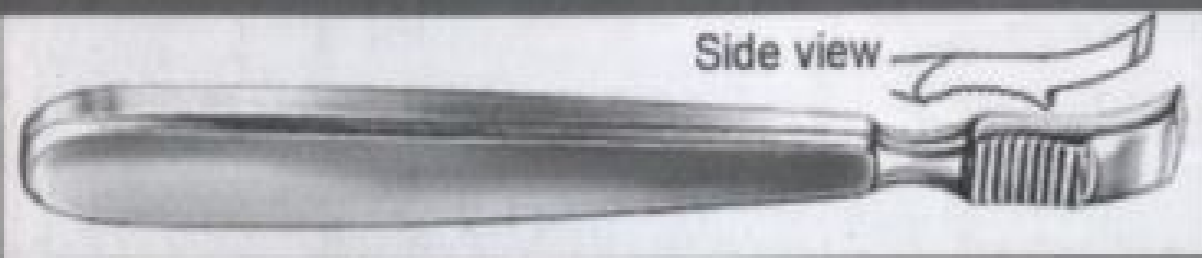

Side view

12-399-15 Farabeuf Periosteal Elevator
15 cm / 6" with hollow handle



12-400-22 (15mm Tip) Sedillot Periosteal Elevator
22 cm / 8 3/4" Side & Front View

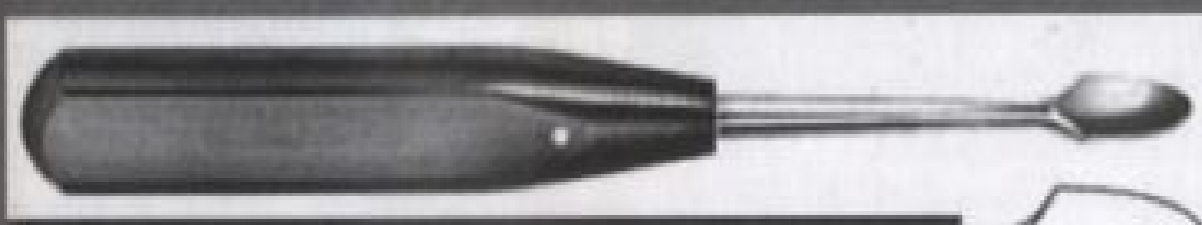

12-402-20 Periosteal Elevator
20 cm / 8" (14 mm Tip) with plastic handle



12-403-19 Periosteal Elevator
19 cm / 7 1/2" (14mm Tip) with plastic handle

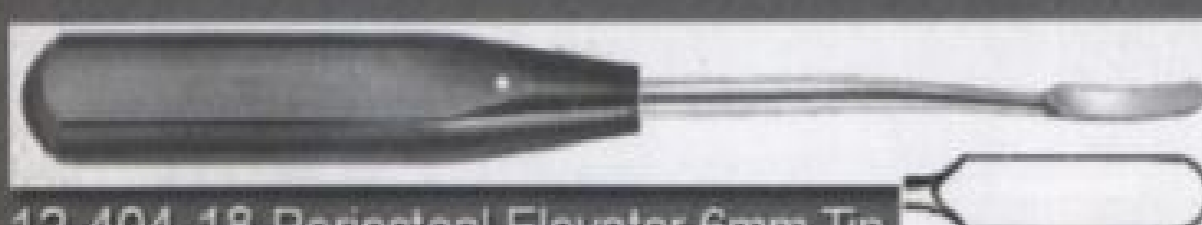

12-404-18 Periosteal Elevator 6mm Tip
18 cm / 7" narrow, con plastic handle



12-405-18 Periosteal Elevator
18 cm / 7" narrow, con plastic handle (6mm Tip)



12-408-12 Williger Periosteal Elevator
12.5 cm / 5" solid 5mm Tip



12-410-18 Periosteal Elevator 3mm Tip
18 cm / 7" extra narrow, with plastic handle



12-412-16 A / B Kahre-Williger Periosteal Elevator solid
16 cm / 6 1/4" B: 7mm A: 5mm

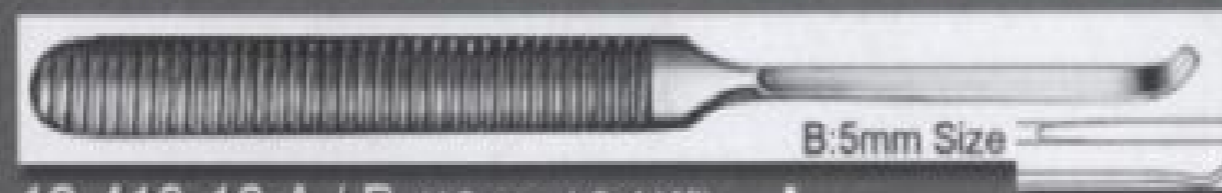

12-413-16 A / B (16 cm / 6 1/4") Kahre-Williger Periosteal Elevator solid
B: 5mm Size A: 4mm Size

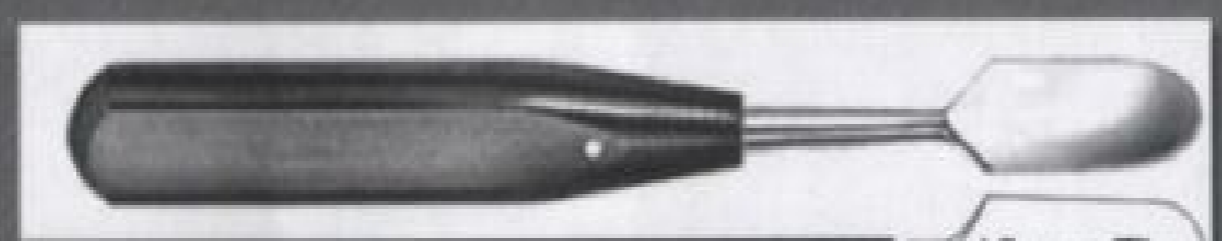

12-416-20 Periosteal Elevator
20 cm / 8" with plastic handle 19 mm Tip

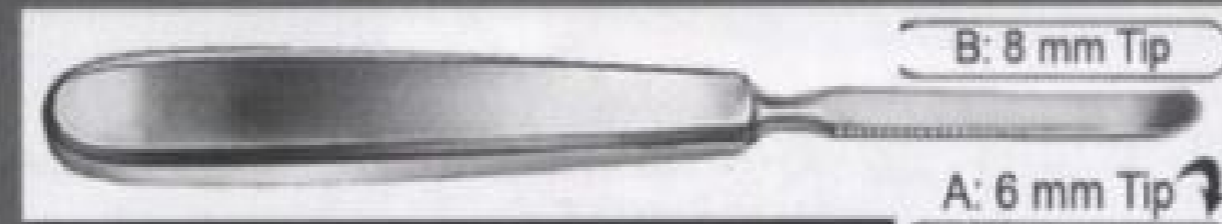

12-418-17 A / B Periosteal Elevator
17 cm / 6 3/4" with hollow handle B: 8 mm Tip A: 6 mm Tip

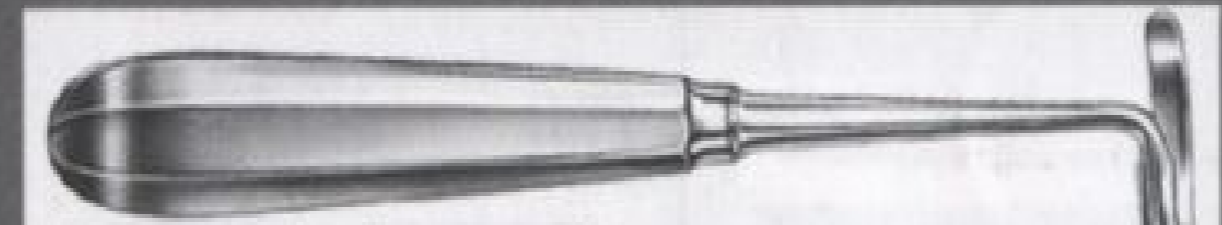

12-420-17 A / B / C / D Doyen Rib Raspatory
17.5 cm / 7" Rib Raspatories with hollow handle

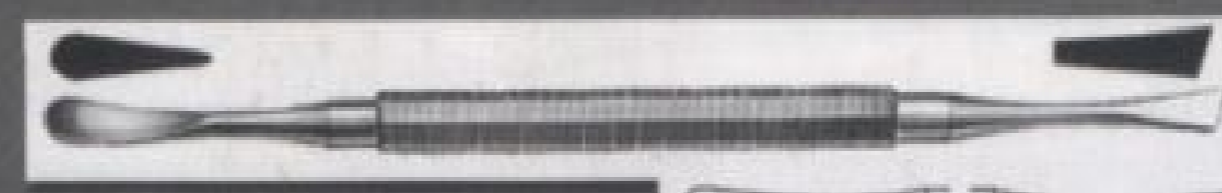

12-422-18 West Periosteal Elevator,
double-ended 18.5 cm / 7 1/4" octagonal handle



12-424-17 Ohl Periosteal Elevator, double-ended 17.5 cm / 7"

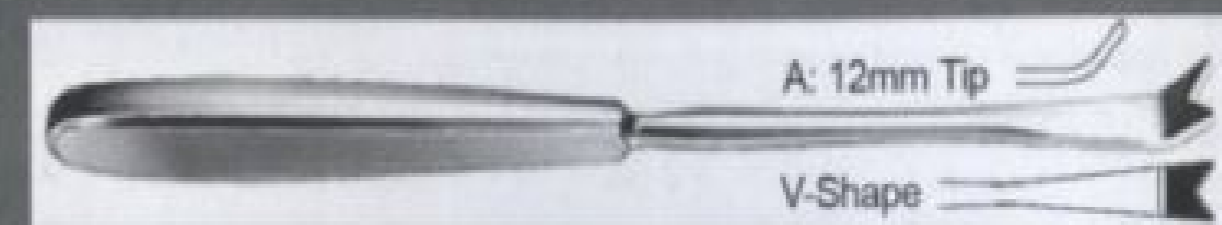

12-426-18 A/B/C/D/E Semb Periosteal Elevator
A+D: 21cm / 8 1/4" & B+C: 18.5 cm / 7 1/4"
A: V-shape 12mm B: Inside round 12mm C: Straight 13mm D: Outer round 15mm



12-428-21 Lambotte Periosteal Elevator
21.5 cm / 8 1/2" A: 10 mm B: 15 mm C: 20 mm D: 25 mm



12-444-17 A/B/C/D Adson Elevator
17.5 cm / 7" 4 types available
A: Flat Type B: Round / Angled Type C: Round / Straight Type D: Round / Curved Type



12-450-19 A / B Langenbeck Elevator
19.5 cm / 7 3/4" B: 10mm A: 8mm



12-451-17 A/B/C/D Martin Langenbeck Elevator
17 cm / 6 3/4" except D A: 5 mm B: 7mm C: 8mm D: 10mm

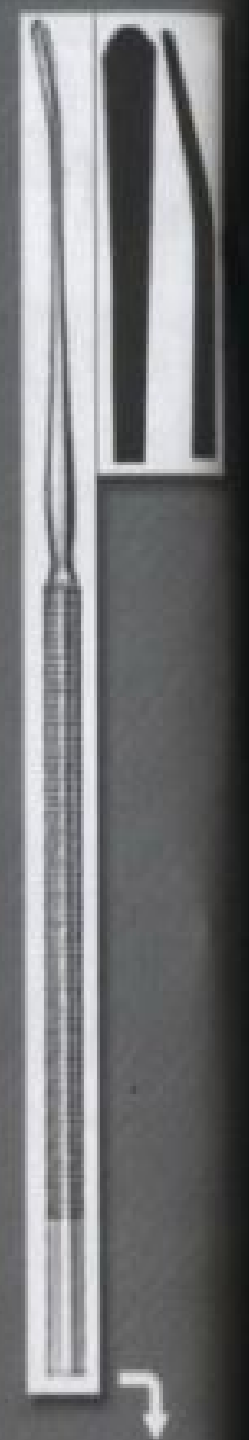

12-454-17 Vickers Dissector
17 cm / 6 3/4"

Tips Sizes
Sizes shown in mm are for tip's width

Elevators / Dissectors

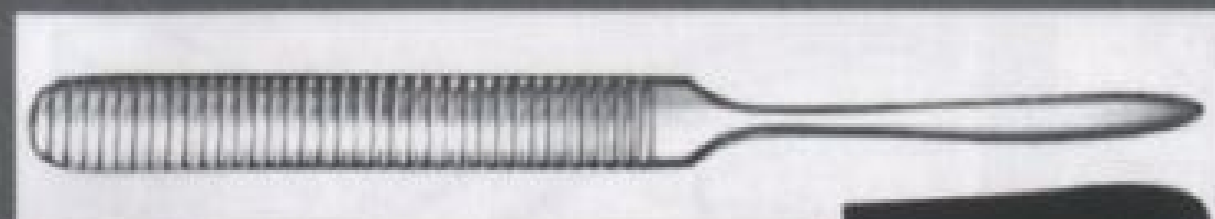

12-456-17 Williger Elevator
17 cm / 6 3/4" 7mm tip



12-457-16 Williger Elevator
16 cm / 6 1/4" (5.5mm tip)



12-458-17 Elevator
17 cm / 6 3/4" Light weight



12-459-16 Micro Elevator
16 cm / 6 1/4"



12-460-16 Phalangeal Elevator
16 cm / 6 1/4"

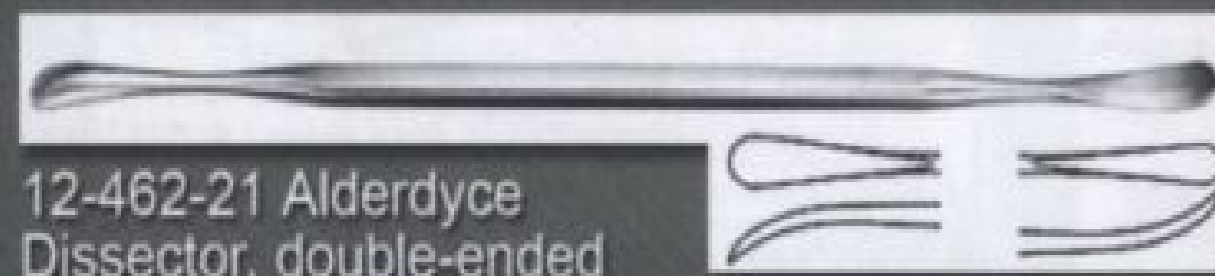

12-462-21 Alderdyce
Dissector, double-ended
21 cm / 8 1/4"

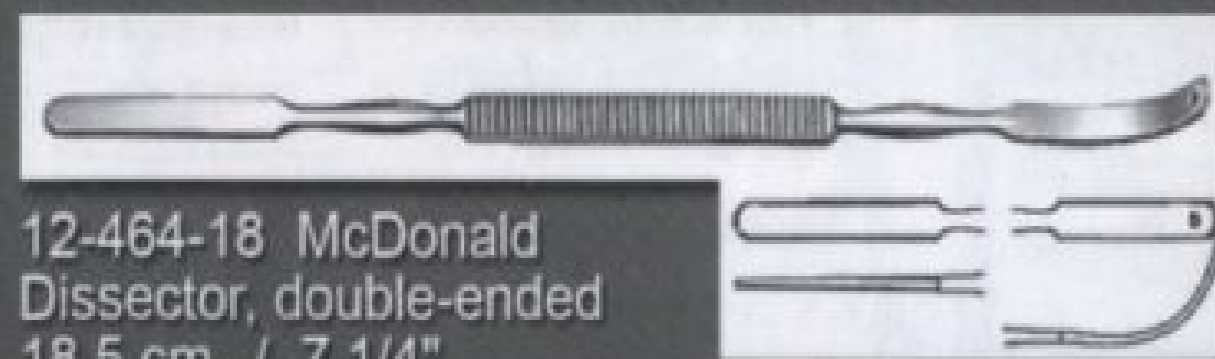

12-464-18 McDonald
Dissector, double-ended
18.5 cm / 7 1/4"

Fingers and Toe instruments



12-640-00 Lead Hand
For Children and Adults



12-647-00 Martin-Ideal
Finger Nail Drill

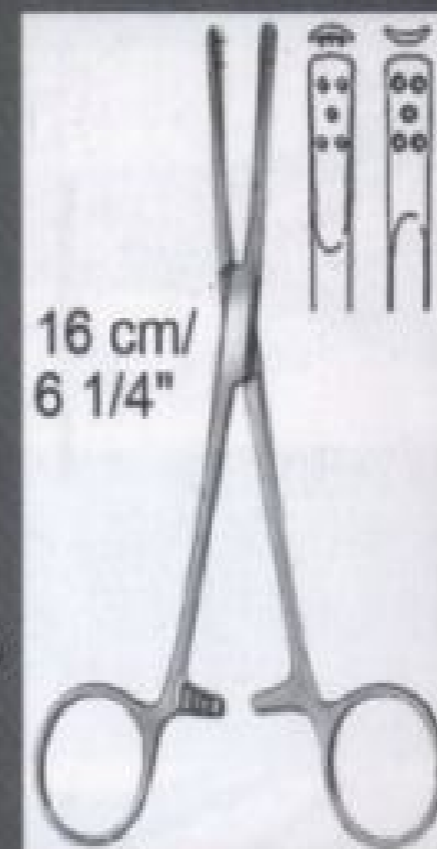

12-652-16 Nail
Extracting Forceps



12-656-14
Radolf

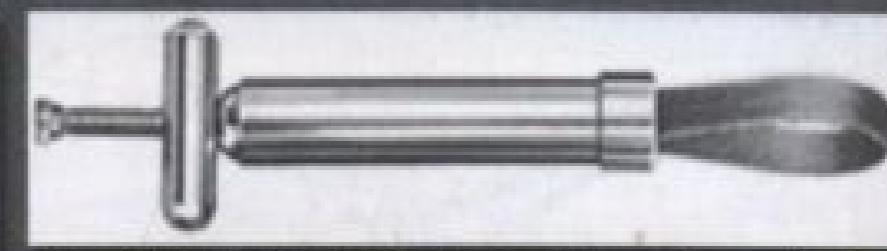

12-645-10 Feldheim Tourniquet
10cm / 4"



12-650-18 Martin Finger
Ring Saw 18.5 cm / 6 3/4"

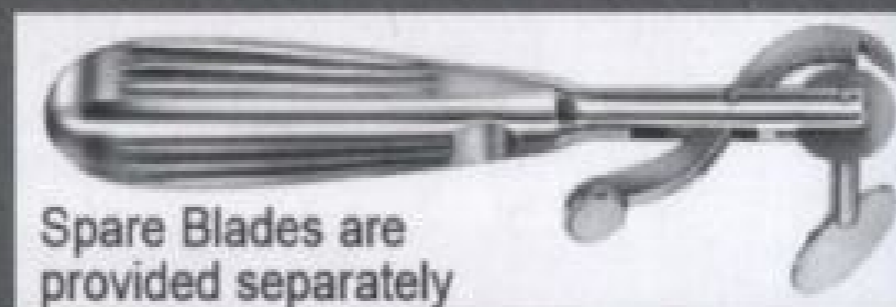

Spare Blades are
provided separately

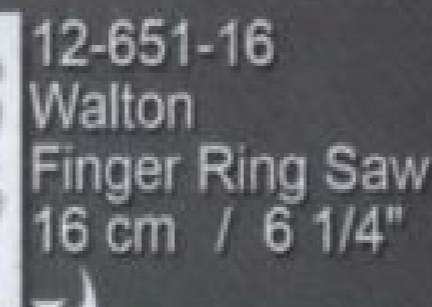

12-651-16
Walton
Finger Ring Saw
16 cm / 6 1/4"



12-654-17
Finger Ring Saw
17 cm / 6 3/4"

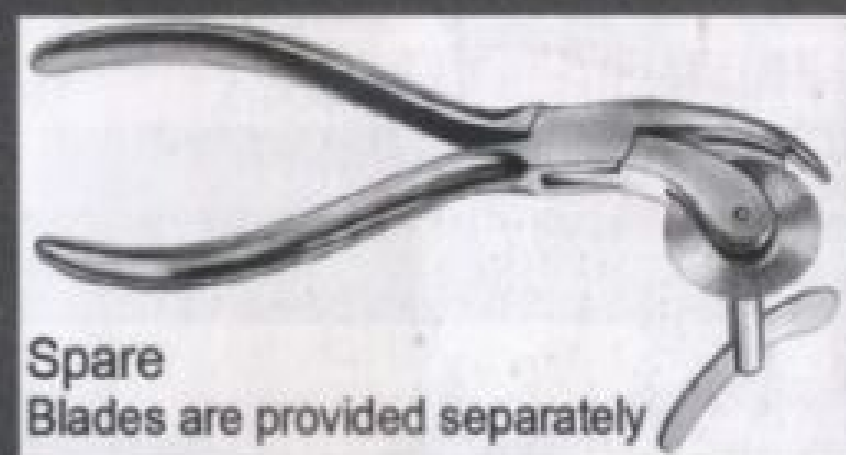

Spare
Blades are provided separately

Bone Cutting Forceps

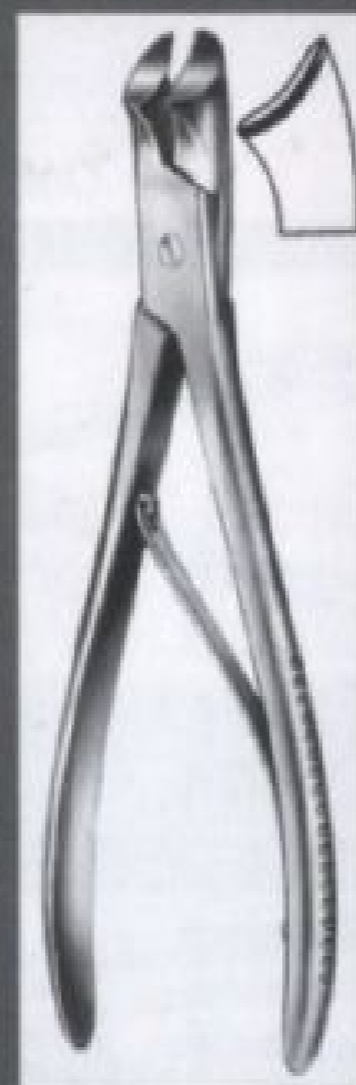

12-610-18
Markwalder
Bone Nipper
18.5 cm / 7 1/4"



12-612-18
Cottle-Kazanjan
Bone Cutting Forceps
18.5 cm / 7 1/4"



12-614-00
A/B/C/D
(4 sizes) Liston
Bone Cutting
Forceps



12-615-00
A/B/C/D
Liston
Bone Cutting
Forceps



12-616-17
Cleveland
Bone Cutting
Forceps
17 cm / 6 3/4"



12-617-14
Cleveland
Bone Cutting
Forceps
14.5 cm /
5 3/4"

Bone Cutting Forceps

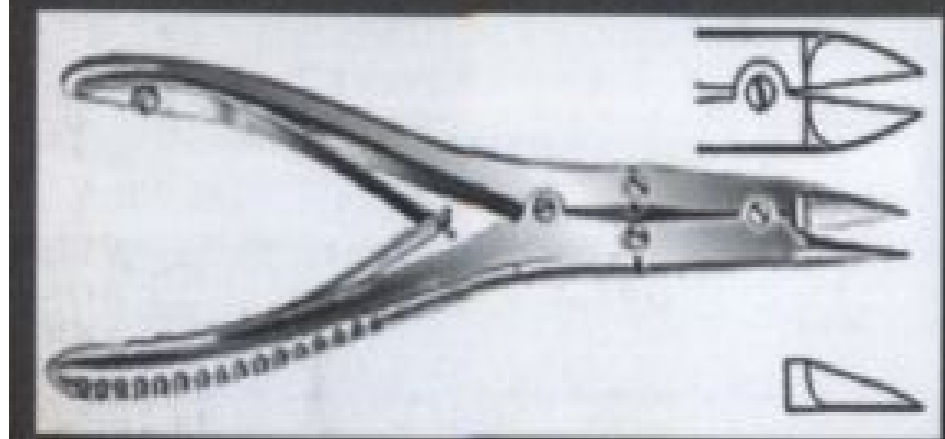

12-620-14 Böhler Bone Cutting Forceps 14.5 cm / 5 3/4"

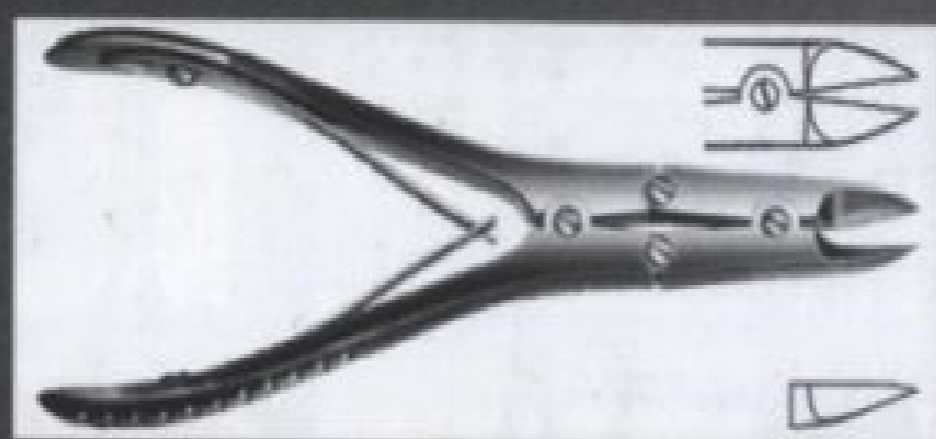

12-621-14 Böhler Bone Cutting Forceps 14.5 cm / 5 3/4"

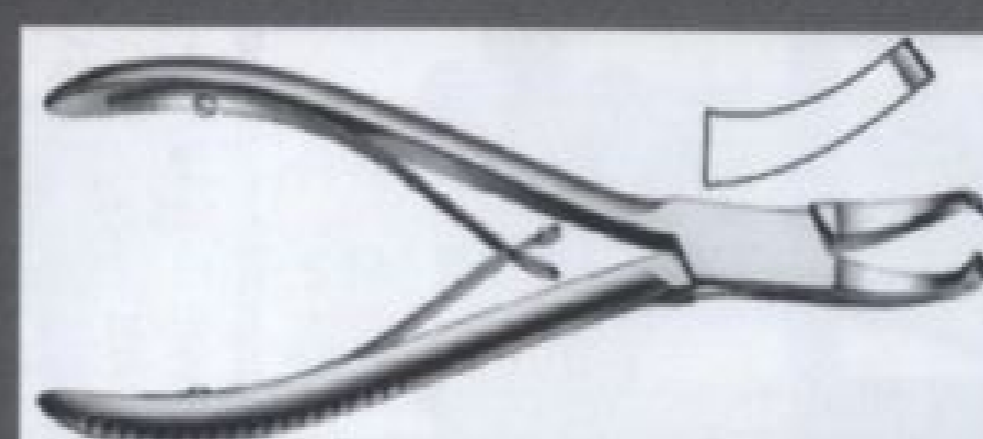

12-622-16 Cleveland Bone Cutting Forceps 16 cm / 6 1/4"

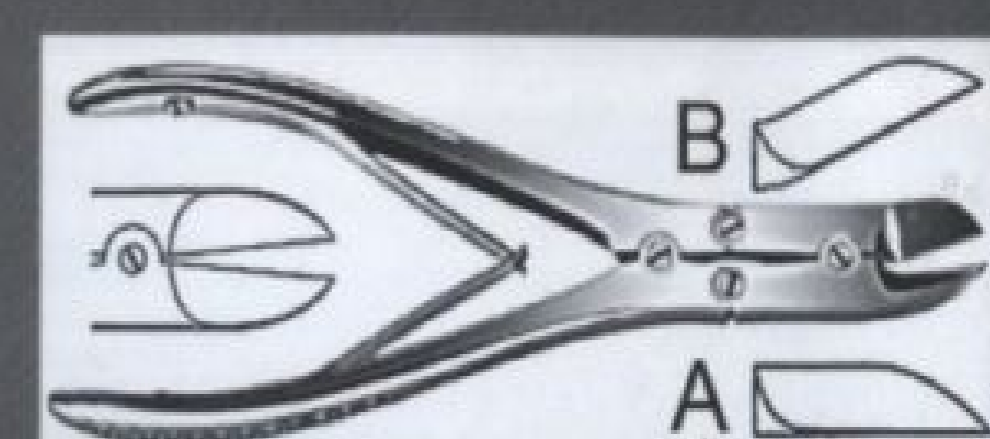

12-623-18 A / B Ruskin-Liston Bone Cutting Forceps 18 cm / 7"

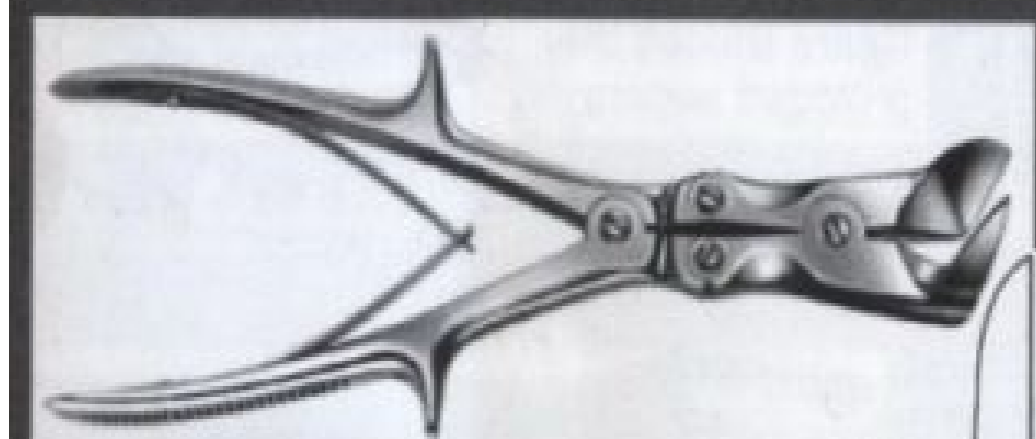

12-624-26 Stille-Liston Bone Cutting Forceps 26 cm / 10 1/4"

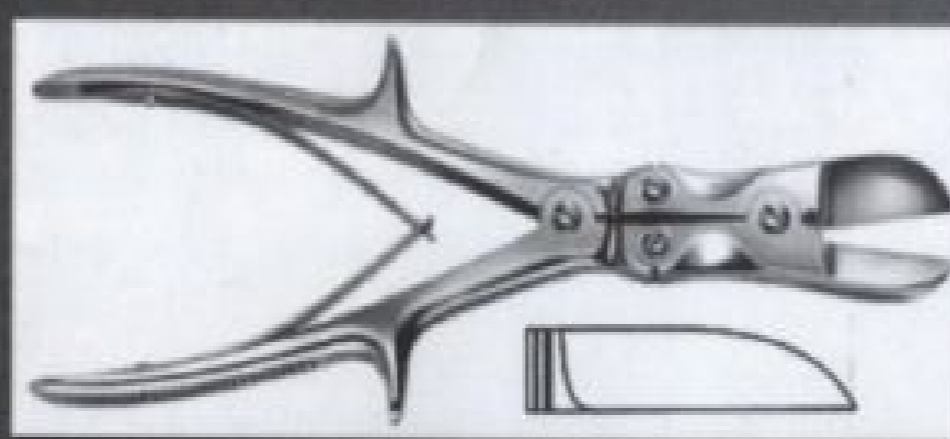

12-625-27 Stille-Liston Bone Cutting Forceps 27.5 cm / 10 3/4"

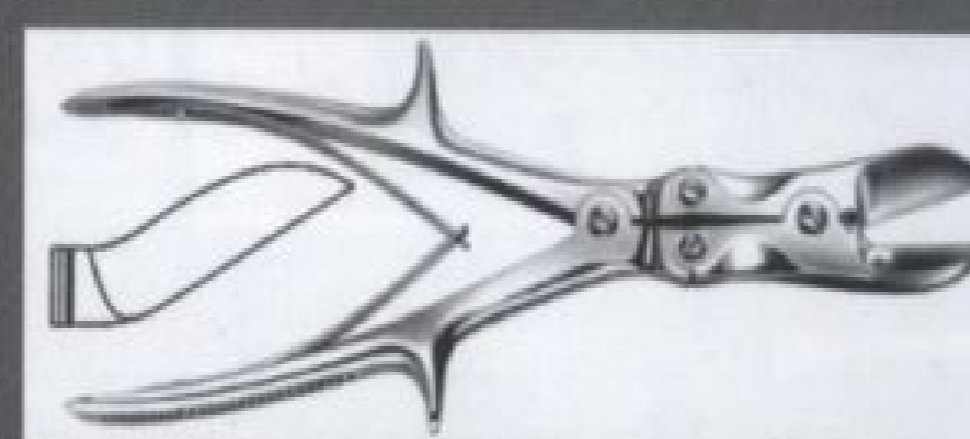

12-626-00 Stille-Liston Bone Cutting Forceps 23.5 cm / 9 1/4" & 27.5 cm / 10 3/4"

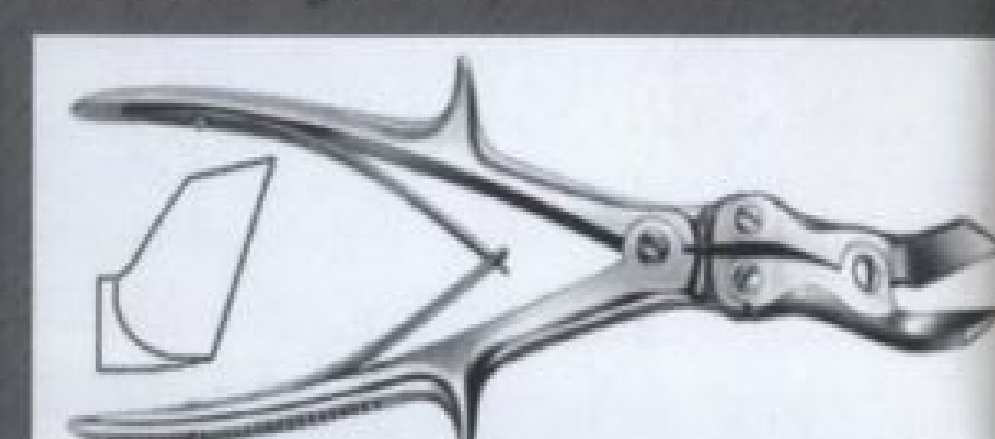

12-627-25 Liston-Key Bone Cutting Forceps 25.5 cm / 10"

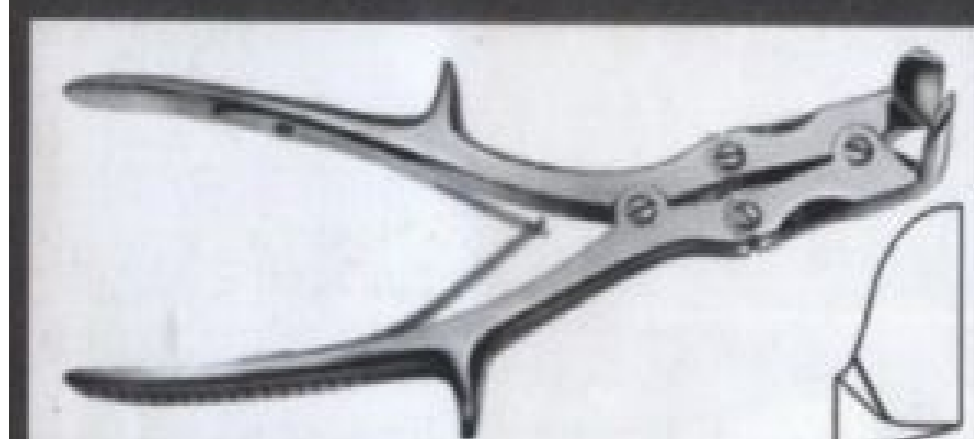

12-628-24 Semb Bone Cutting Forceps 24.5 cm / 9 3/4"

Bone Holding Forceps

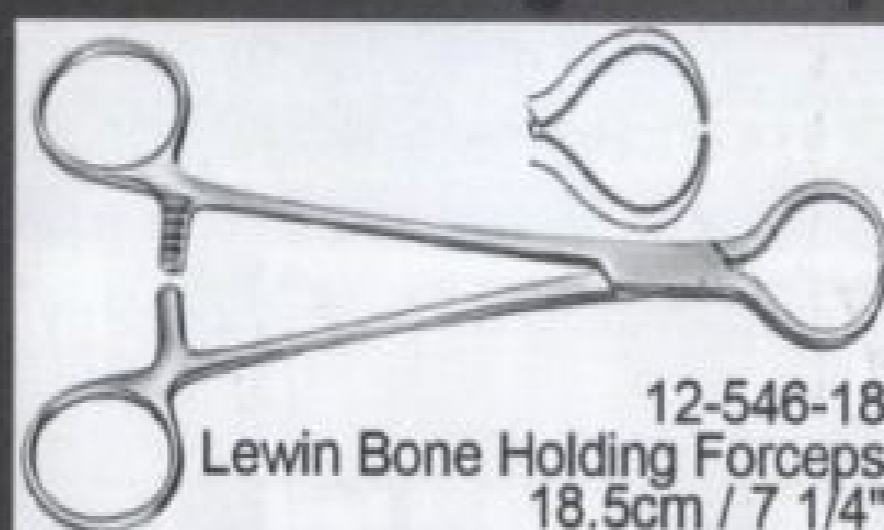

12-546-18 Lewin Bone Holding Forceps 18.5cm / 7 1/4"

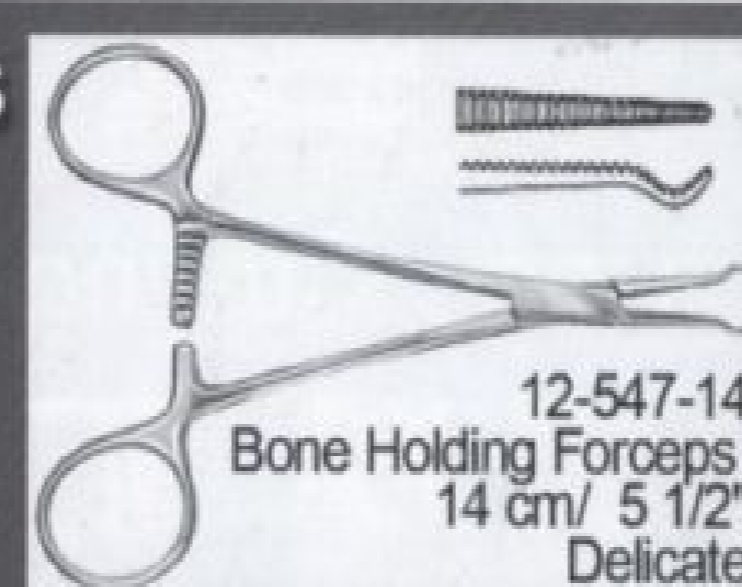

12-547-14 Bone Holding Forceps 14 cm / 5 1/2" Delicate

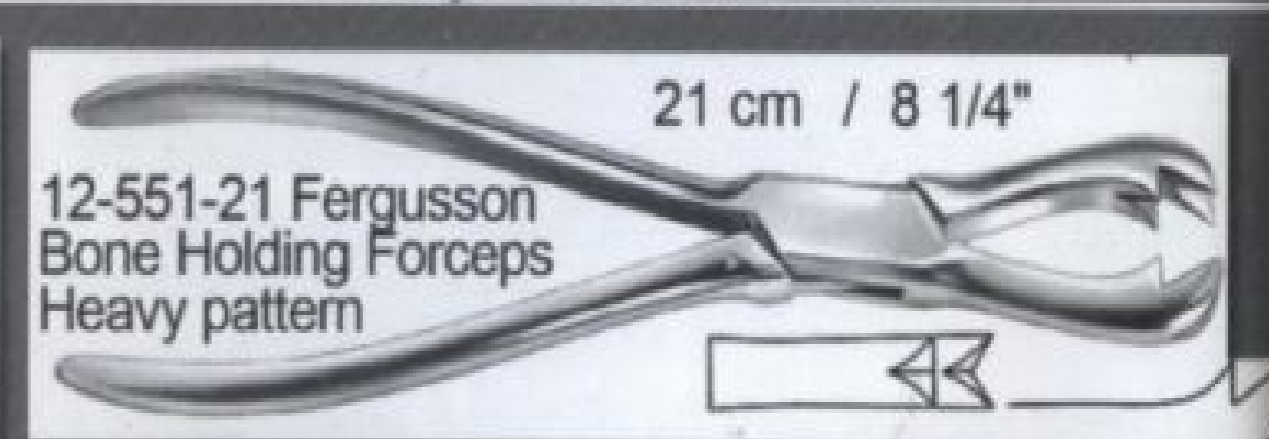

12-551-21 Fergusson Bone Holding Forceps Heavy pattern 21 cm / 8 1/4"

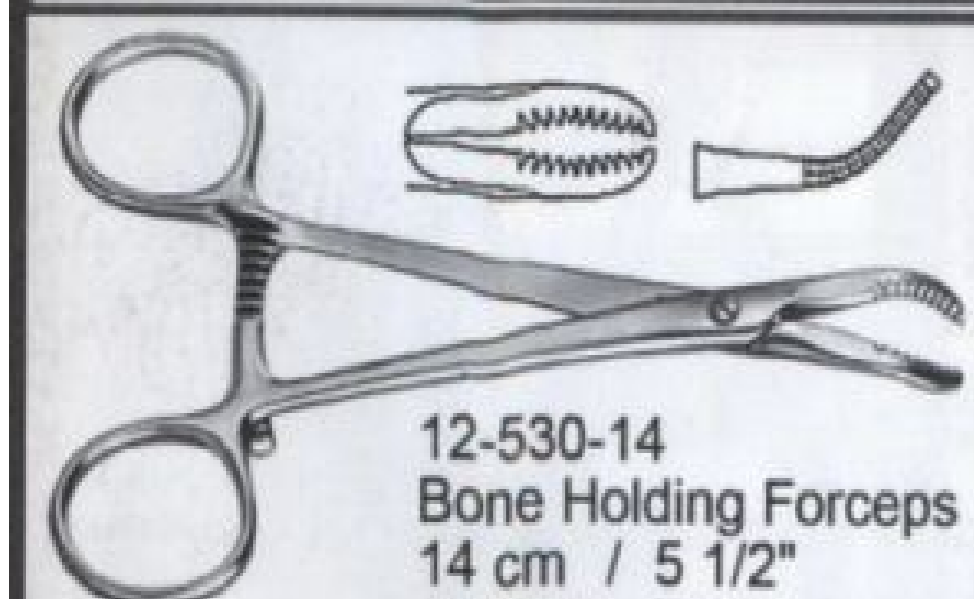

12-530-14 Bone Holding Forceps 14 cm / 5 1/2"

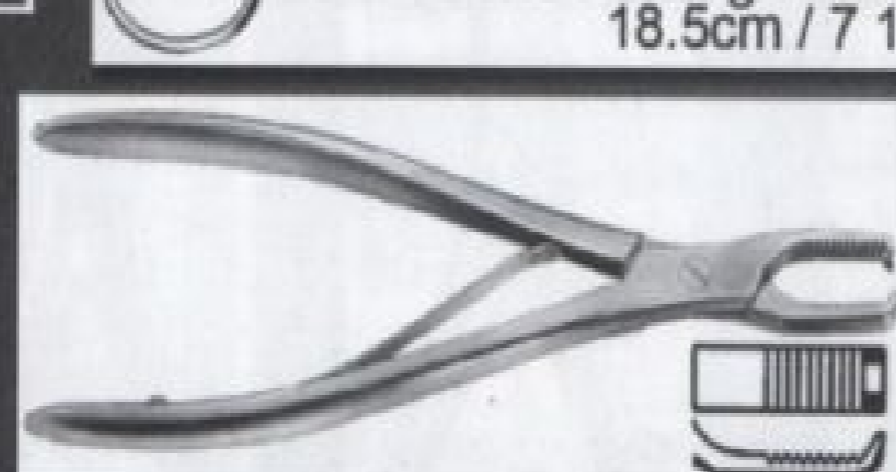

12-552-18 Frosch Bone Holding Forceps 18 cm / 7"



12-553-20 Bone Holding Forceps 20 cm / 8"



12-556-17 A / B Kern Bone H Forceps A: 17cm / 6 3/4" B: 21cm / 8 1/4"

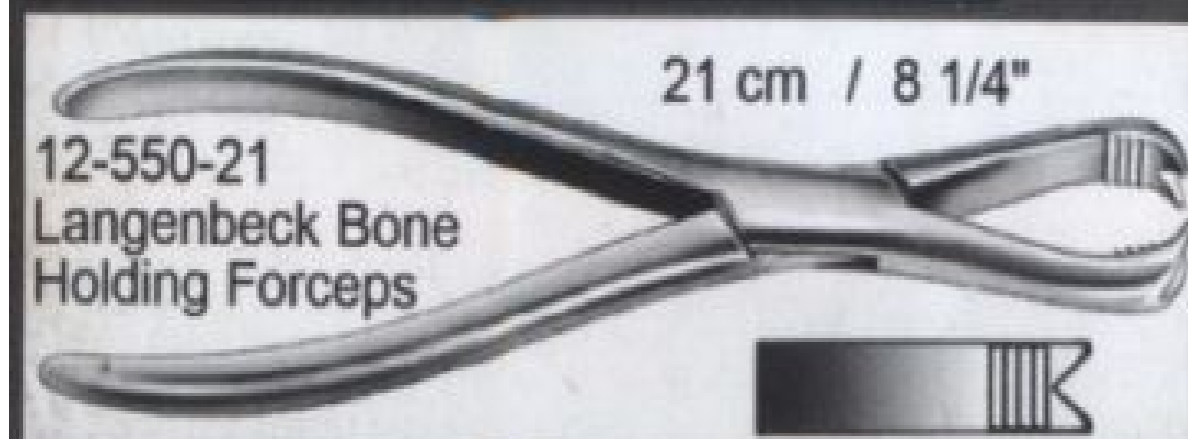

12-550-21 Langenbeck Bone Holding Forceps 21 cm / 8 1/4"

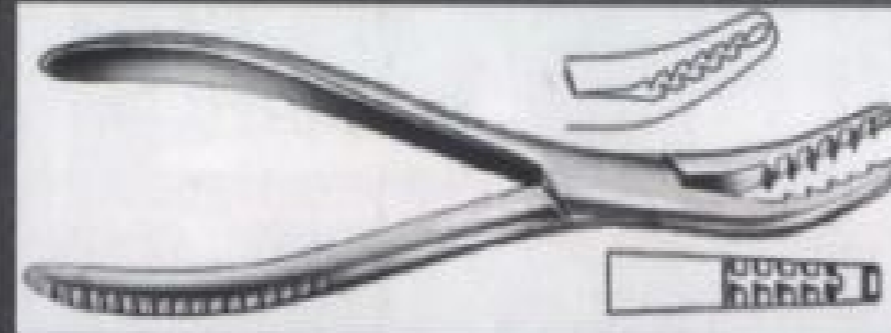

12-557-19 Semb Bone Holding Forceps 19 cm / 7 1/2"



12-558-23 Farabeuf Bone Holding Forceps 23cm / 9" & 26 cm / 10 1/4"



12-559-26 Farabeuf Bone Holding Forceps 26 cm / 10 1/4"

Bone Holding Forceps



12-560-22 Lambotte Bone Holding Forceps one flexible jaw

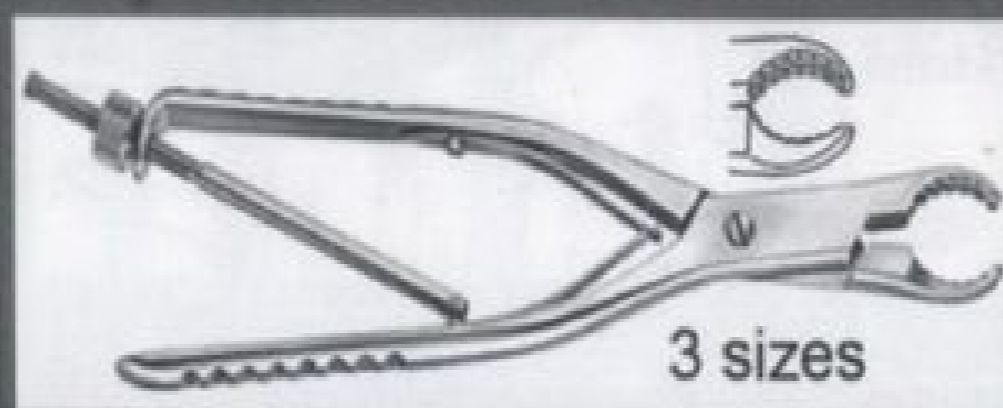

12-561-23 A / B / C Ulrich Bone Holding Forceps with thread fixation (3 Sizes)

Available Sizes A: 23 cm / 9"
B: 25 cm / 9 3/4" C: 28 cm / 11"

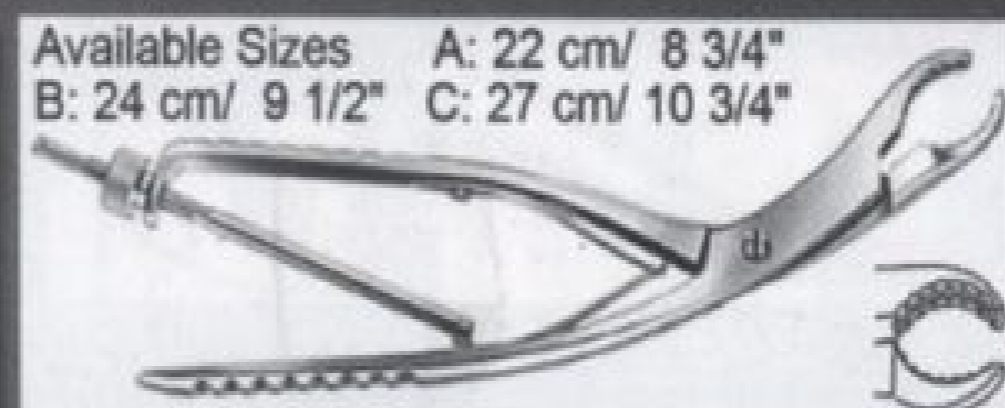

12-562-22 A / B / C Ulrich Bone Holding Forceps with thread fixation

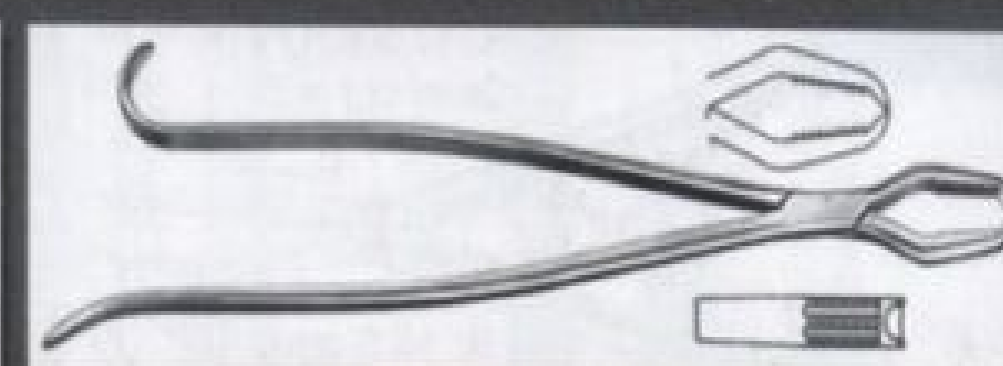

12-564-33 Lane Bone Holding Forceps 33 cm / 13" With and without ratchet

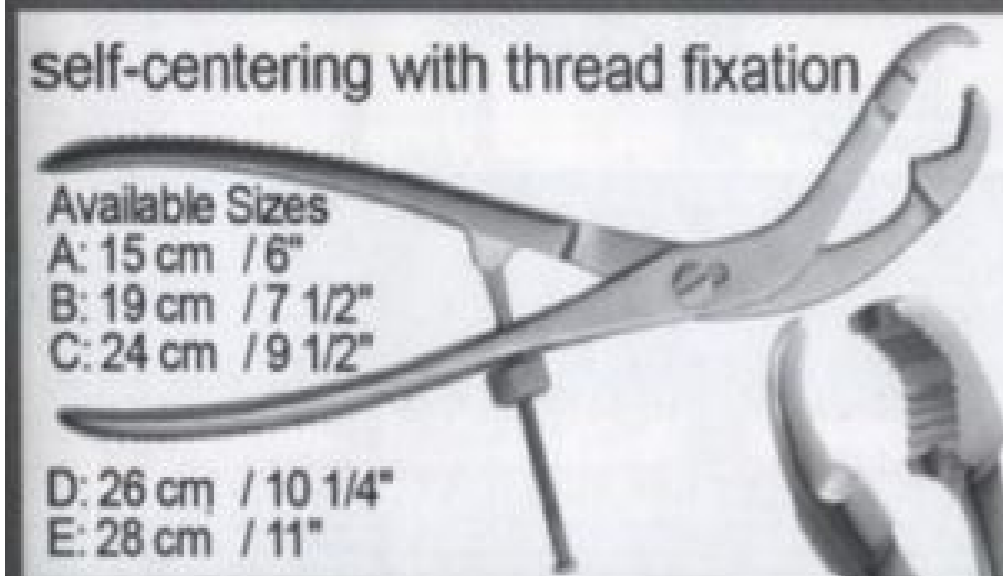

12-563-00 A / B / C / D / E (5 Sizes) Bone Holding Forceps

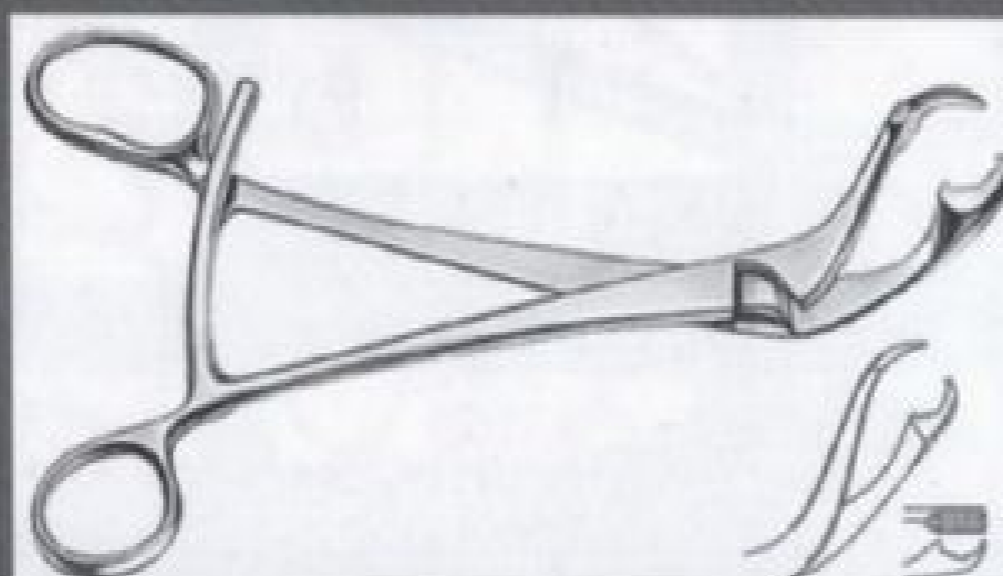

12-565-17 Verbrugge Bone Holding Forceps 17.5 cm / 7"

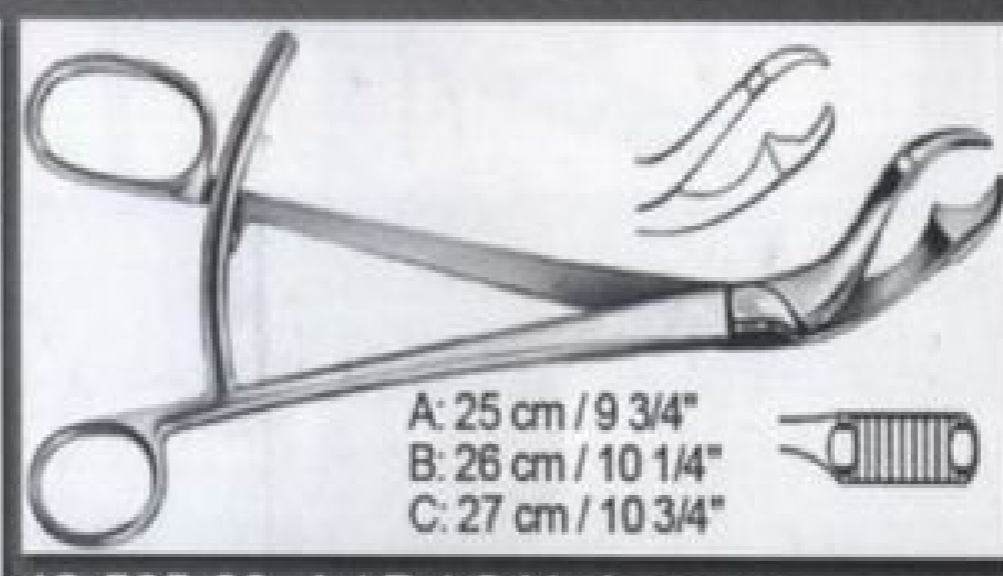

12-565-00 A / B / C Verbrugge Bone Holding Forceps

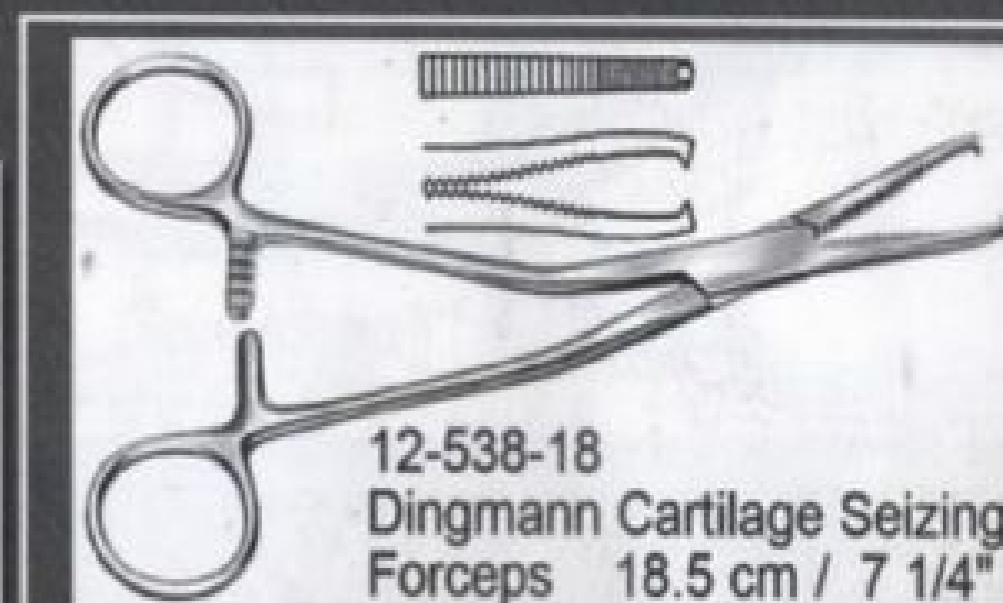

12-538-18 Dingmann Cartilage Seizing Forceps 18.5 cm / 7 1/4"

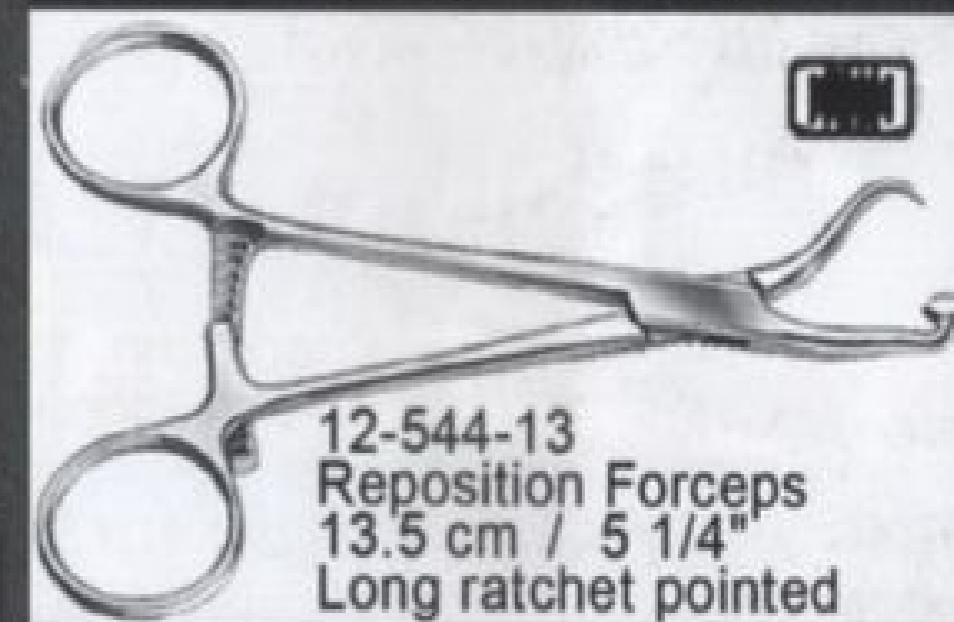

12-544-13 Reposition Forceps 13.5 cm / 5 1/4" Long ratchet pointed

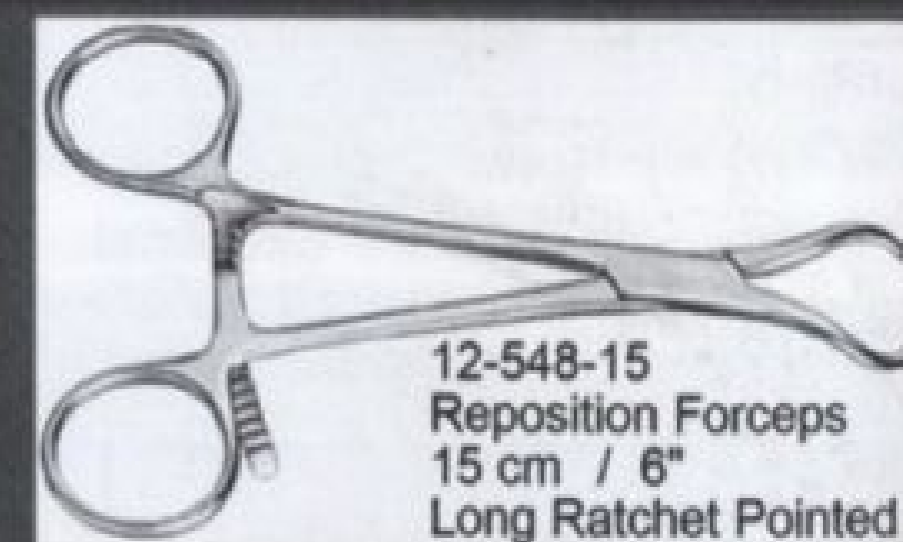

12-548-15 Reposition Forceps 15 cm / 6" Long Ratchet Pointed

Cartilage Seizing / Repositioning Forceps

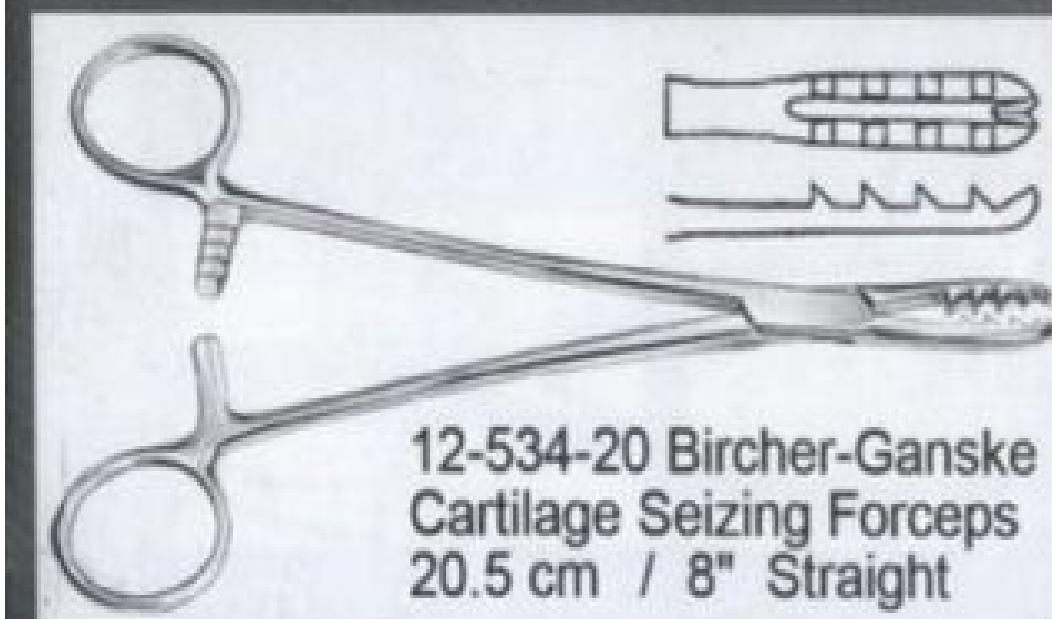

12-534-20 Bircher-Ganske Cartilage Seizing Forceps 20.5 cm / 8" Straight

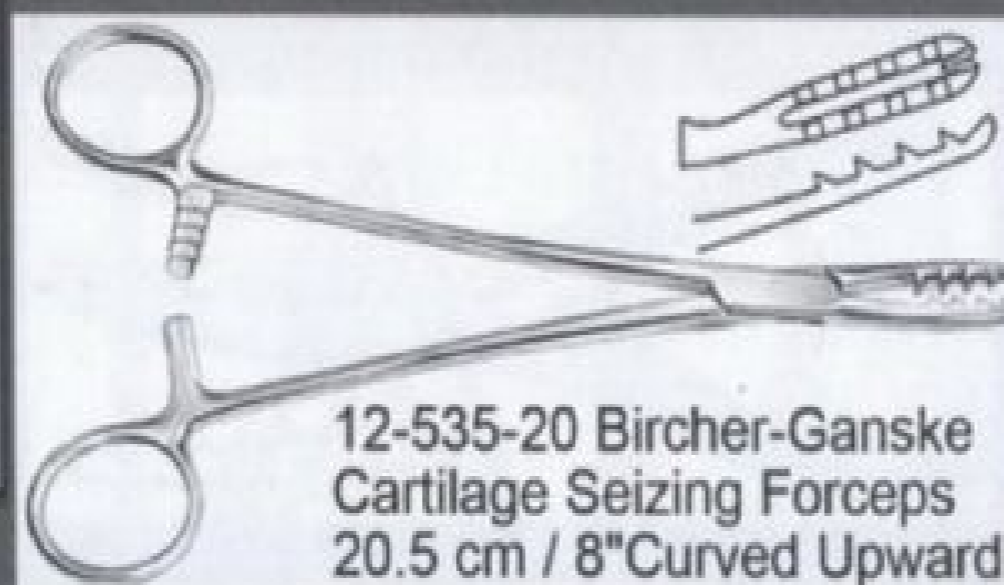

12-535-20 Bircher-Ganske Cartilage Seizing Forceps 20.5 cm / 8" Curved Upward

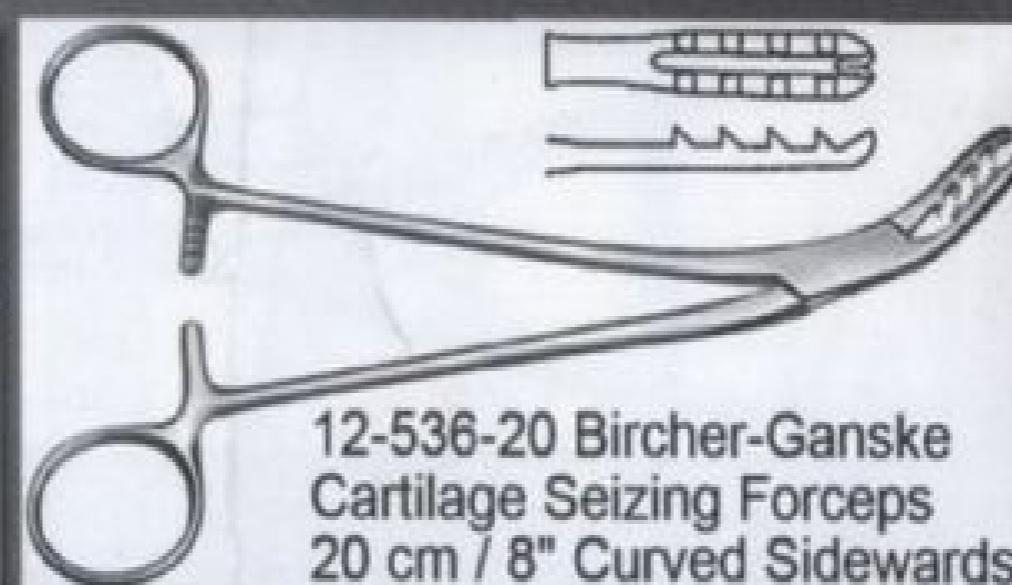

12-536-20 Bircher-Ganske Cartilage Seizing Forceps 20 cm / 8" Curved Sideways

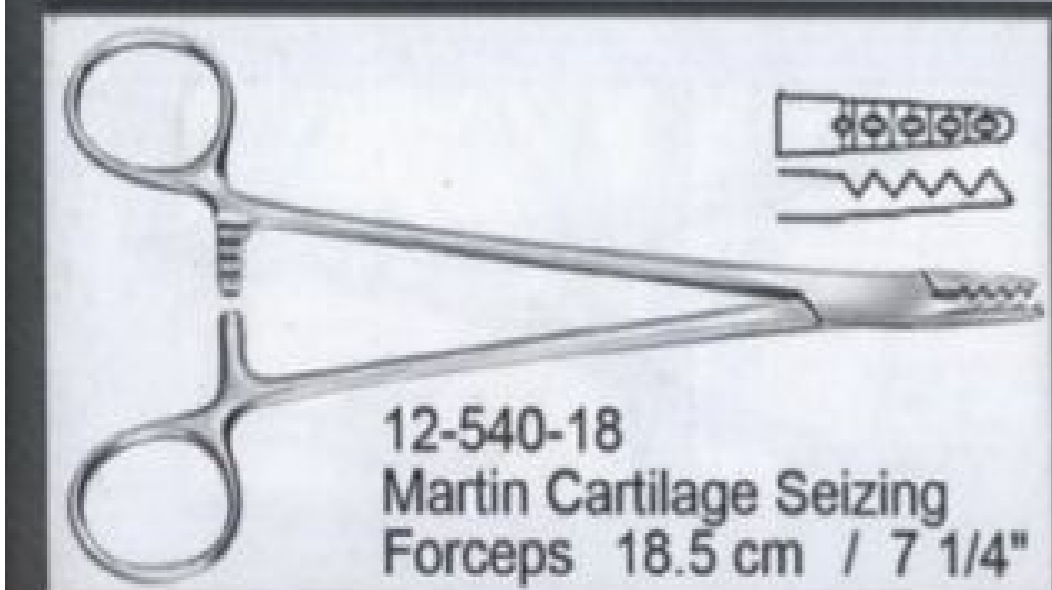

12-540-18 Martin Cartilage Seizing Forceps 18.5 cm / 7 1/4"



12-555-17 Reposition Forceps 17 cm / 6 3/4" with Thread Fixation

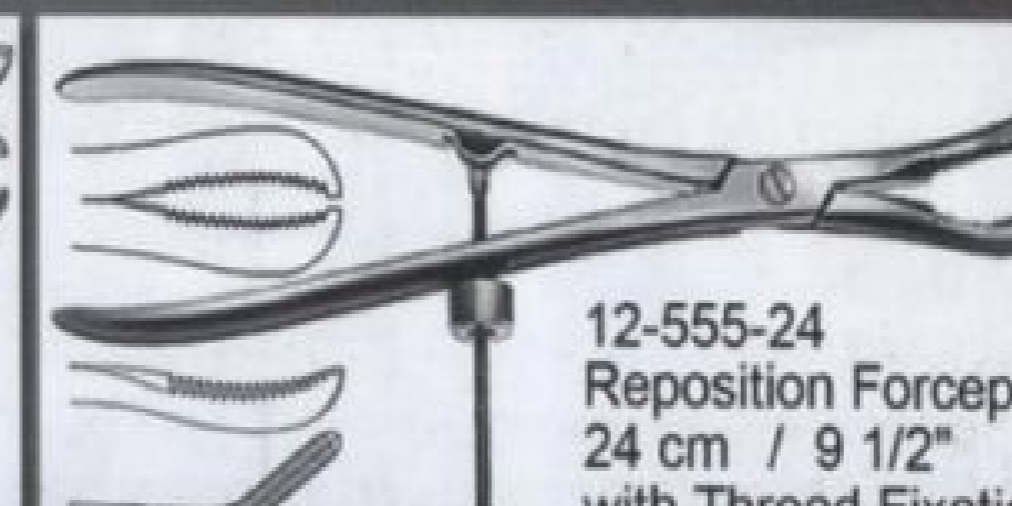

12-555-24 Reposition Forceps 24 cm / 9 1/2" with Thread Fixation



12-570-00 Percy Amputation Retractor Detachable

Bone Rongeurs

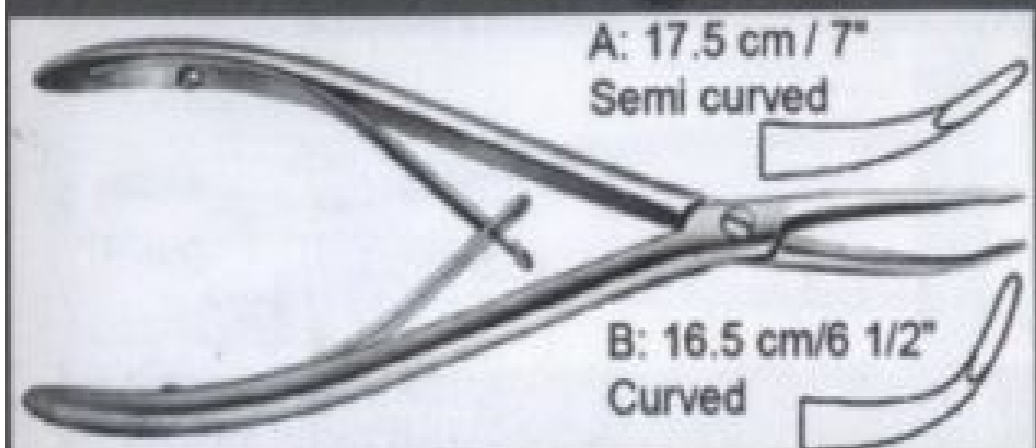

12-575-17 A / B Stellbrink Bone Rongeur

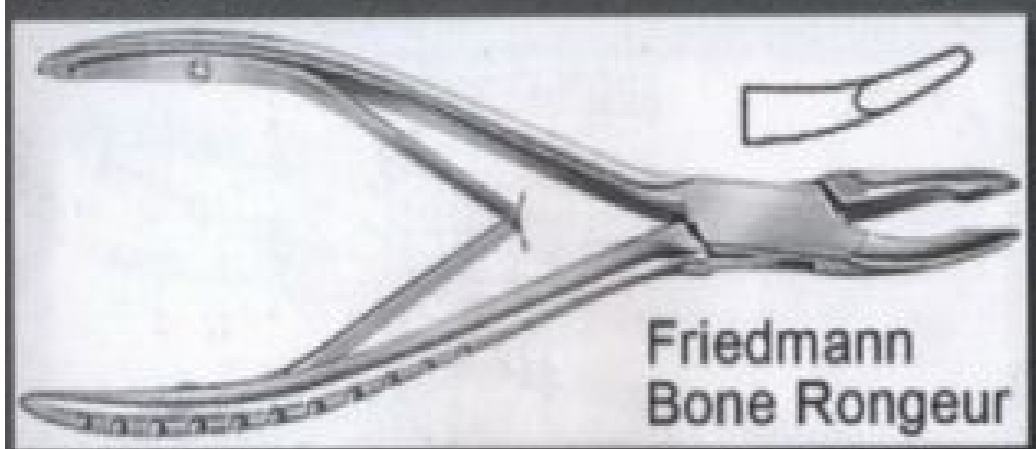

12-576-12 (12.5cm / 5") &
12-576-13 (13.5cm / 5 1/4")

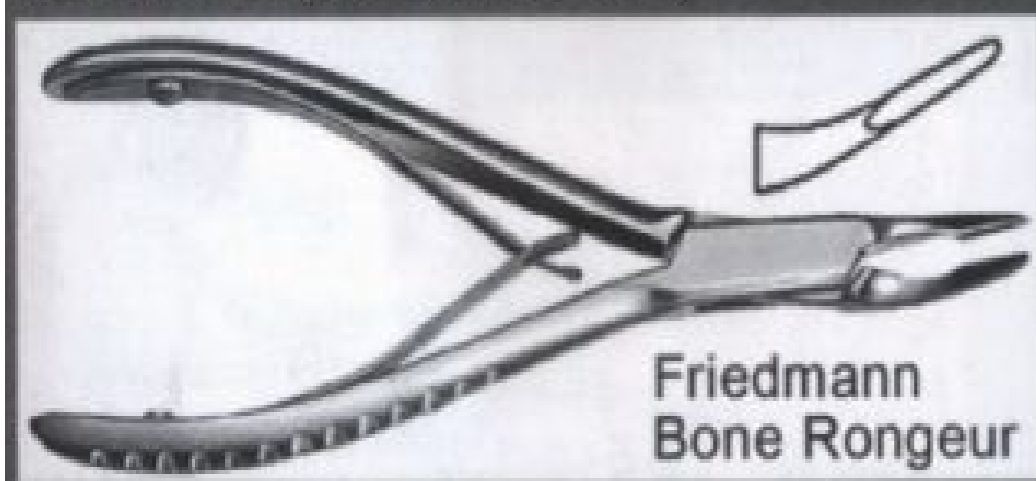

12-577-13 13.5 cm / 5 1/4"

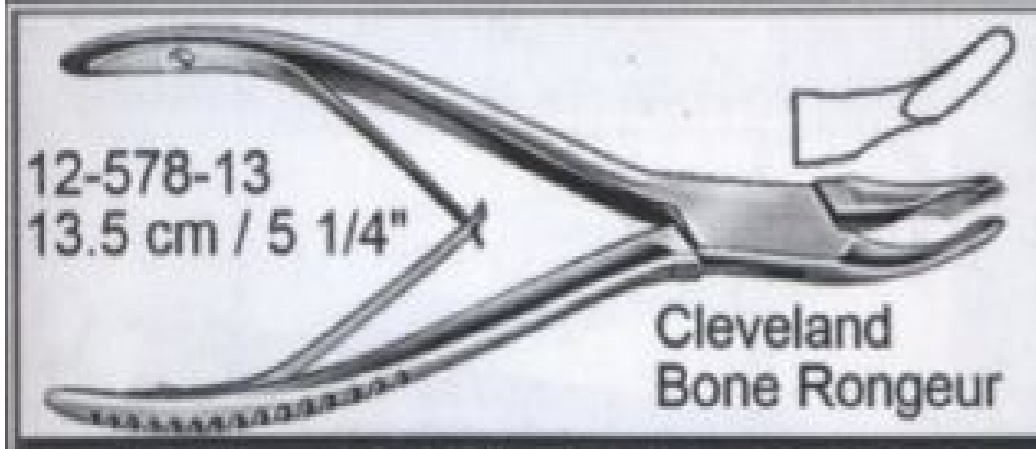

For 16.5 cm / 6 1/2" Art # is 12-578-16

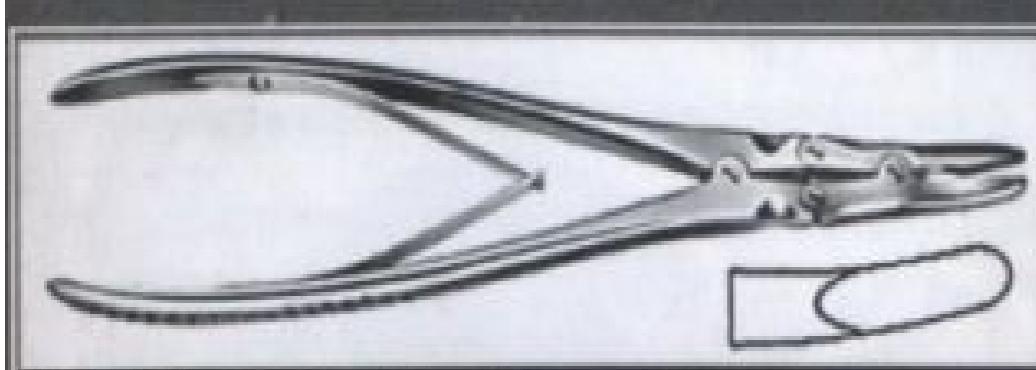

12-591-19 Ruskin Bone Rongeur
19 cm / 7 1/2"

Also available:
12-592-24 Ruskin Bone Rongeur
24 cm / 9 1/2"

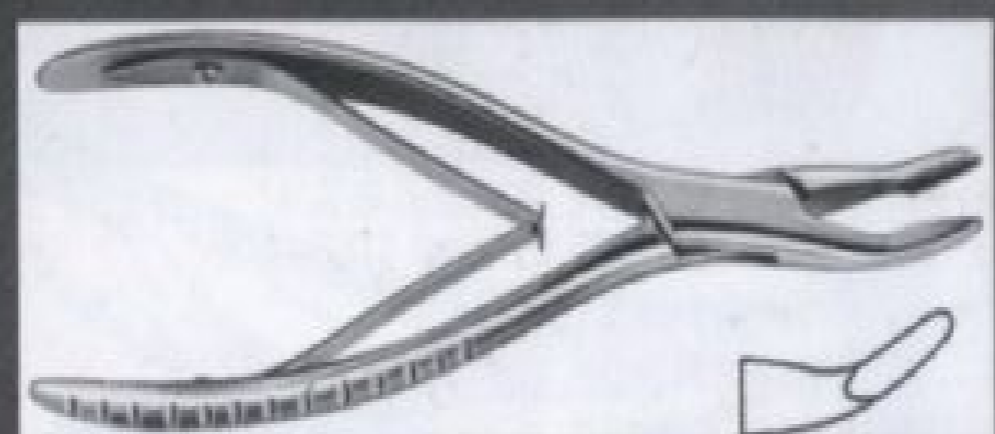

12-579-16 Mead Bone Rongeur
16.5 cm / 6 1/2"



12-580-17 Hartmann Bone Rongeur
17.5 cm / 7"

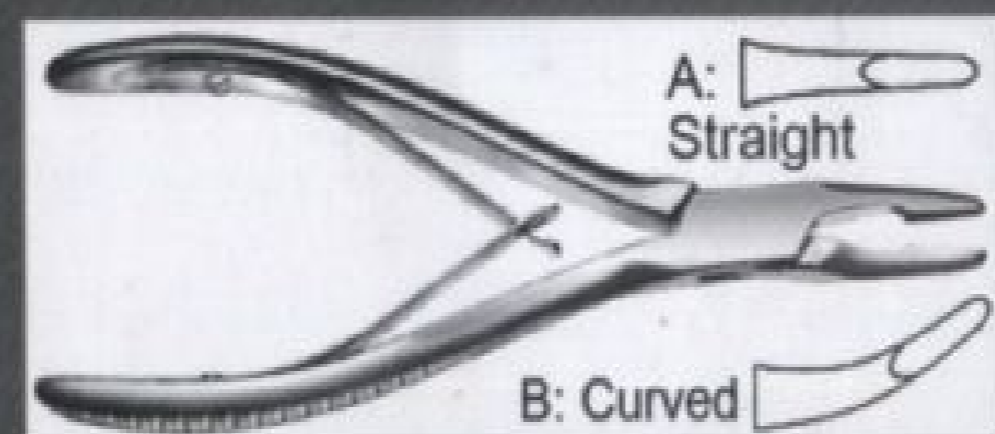

12-581-18 A / B Jansen Bone Rongeur
18 cm / 7"

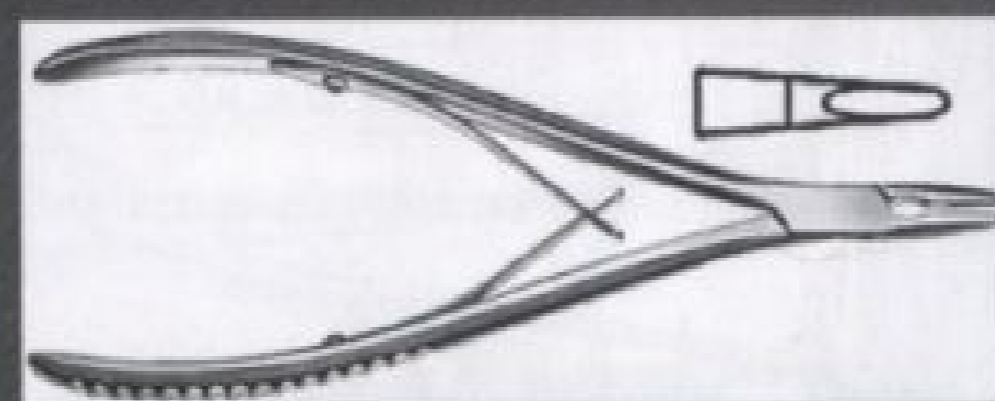

12-582-19 Lempert Bone Rongeur
19 cm / 7 1/2"

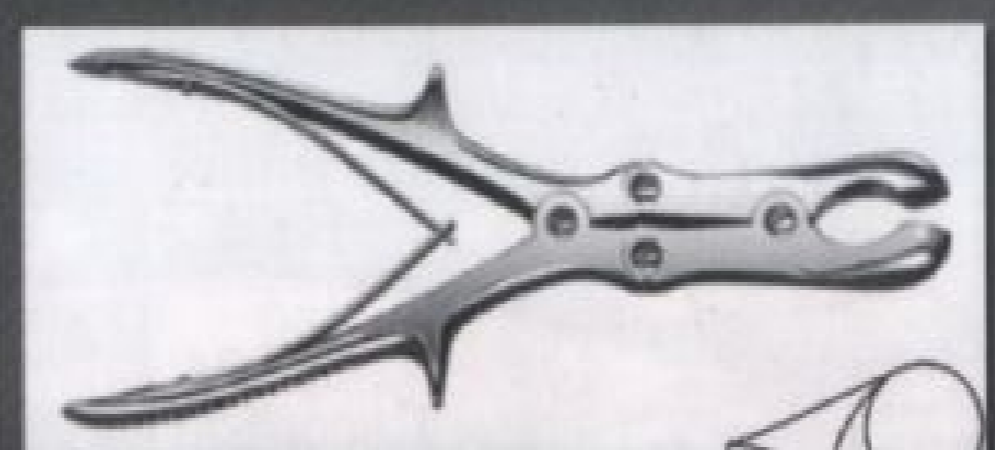

12-593-23 Semb Bone Rongeur
23.5 cm / 9 1/4"

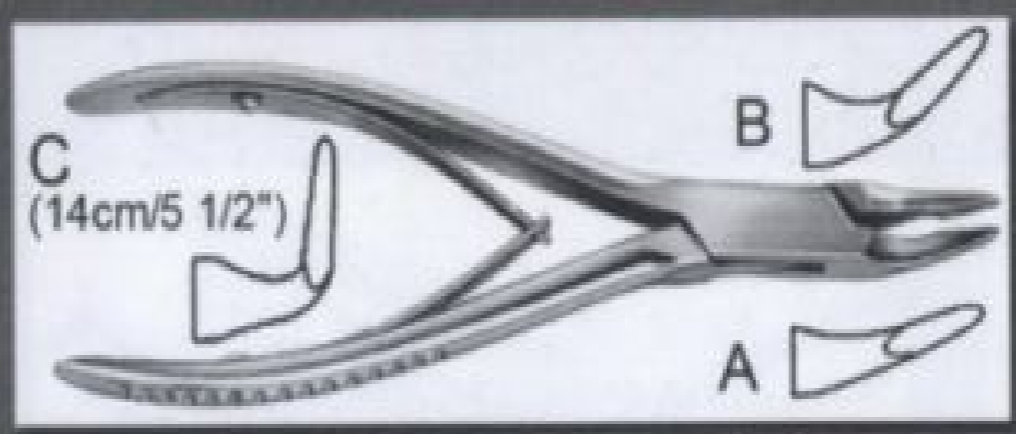

12-583-15 A / B / C Blumenthal Bone Rongeur
15cm / 6" (A / B)

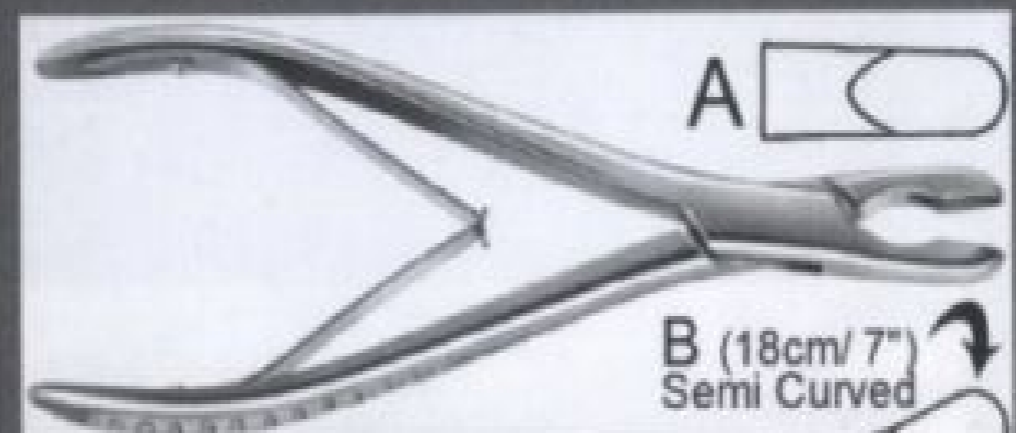

12-584-18 A / B Luer Bone Rongeur
18.5 cm / 7 1/4" (A)

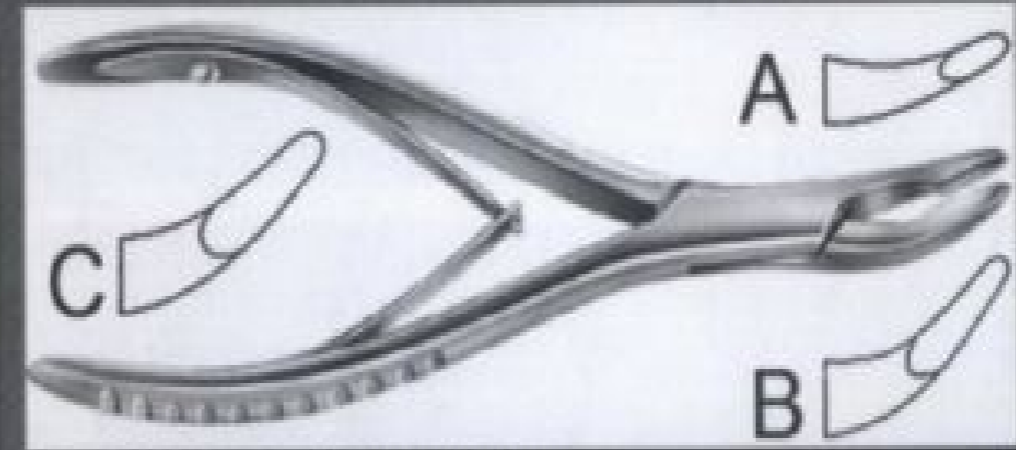

12-585-14 A / B / C Luer Bone Rongeur
14.5 cm / 5 3/4"



12-586-15 A / B Böhler Bone Rongeur
15.5 cm / 6"

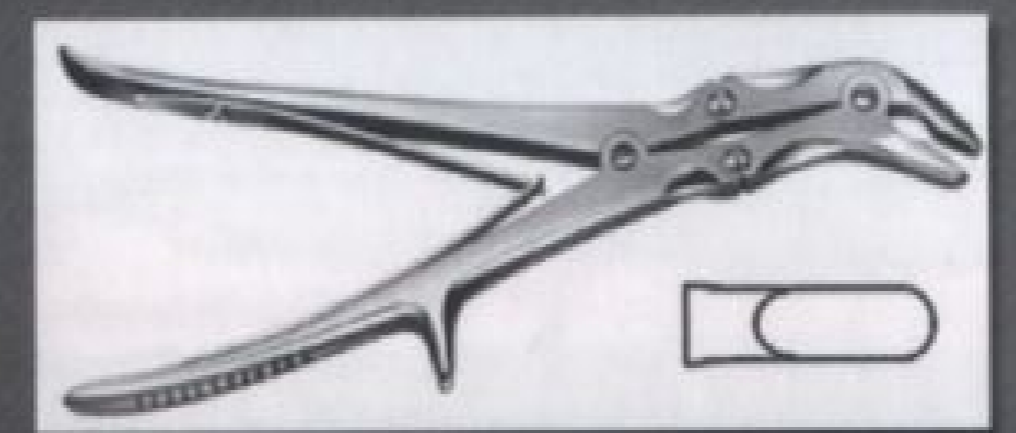

12-594-22 Stille Bone Rongeur
22.5 cm / 8 3/4"

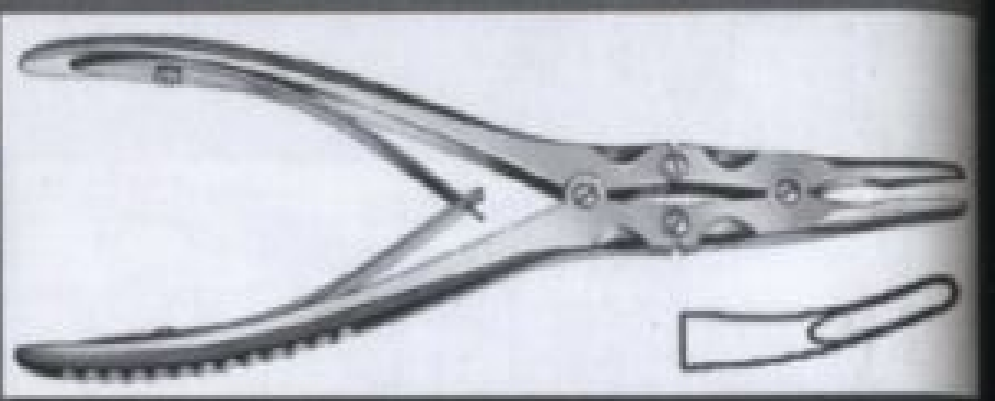

12-587-18 Beyer Bone Rongeur
18 cm / 7"

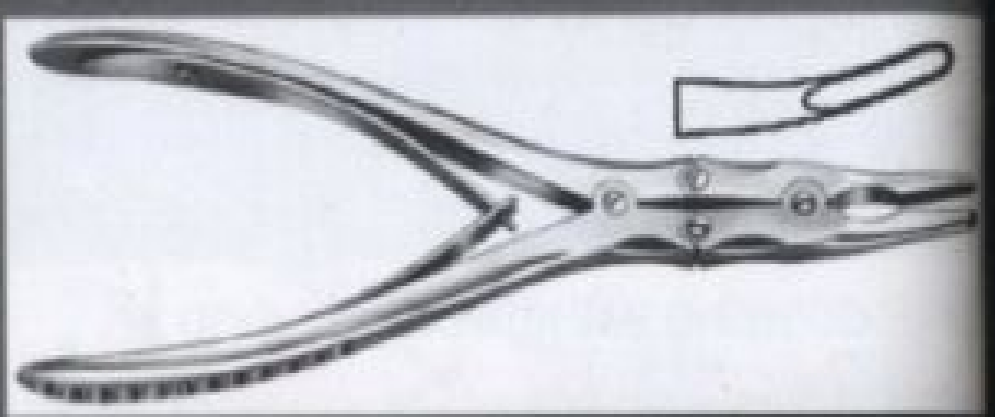

12-588-18 Zaufal-Jansen Bone Rongeur
18 cm / 7"

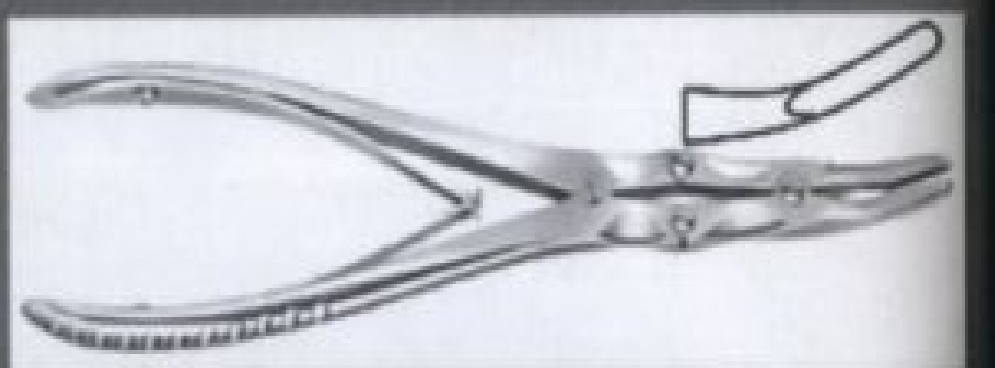

12-589-18 Mayfield Bone Rongeur
18 cm / 7"

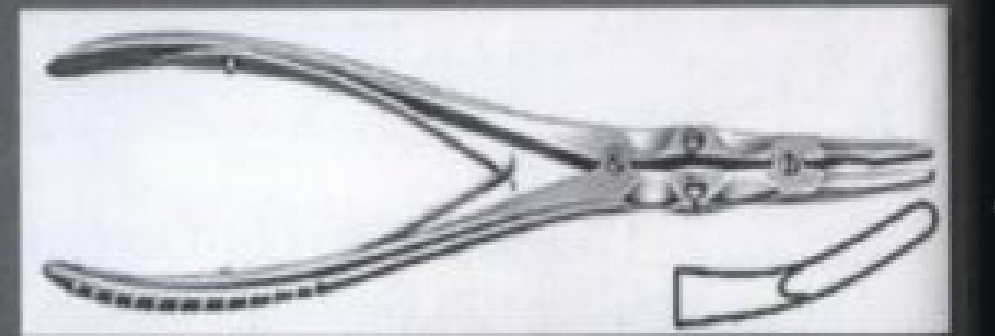

12-590-20 Marquard Bone Rongeur
20.5 cm / 8"

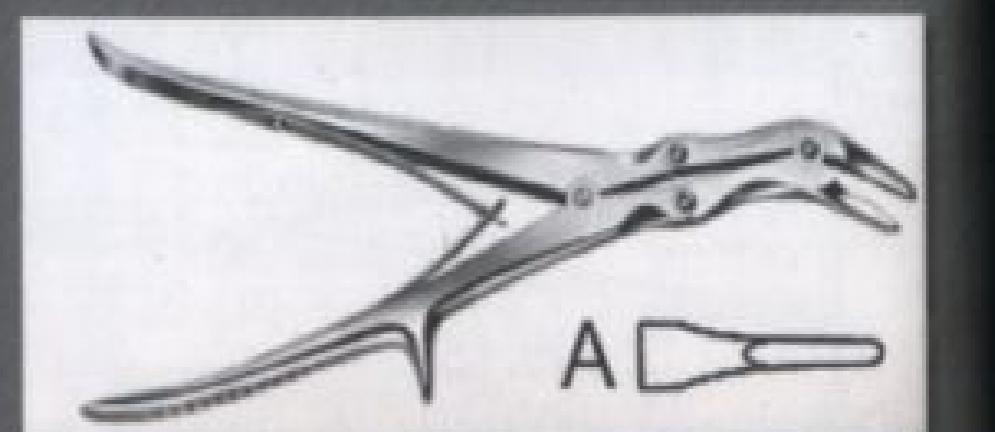

12-595-23 A / B / C Stille Bone Rongeur
22.5 cm / 8 3/4"

Bone Rongeurs

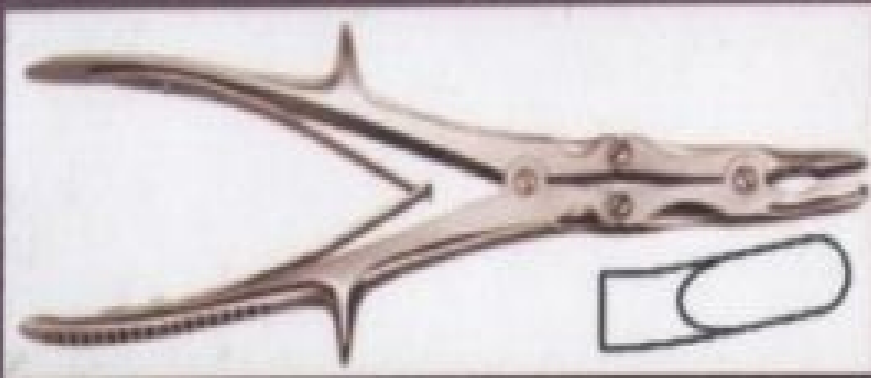

12-596-23 Stille-Ruskin Bone Rongeur 23.5 cm / 9 1/4"

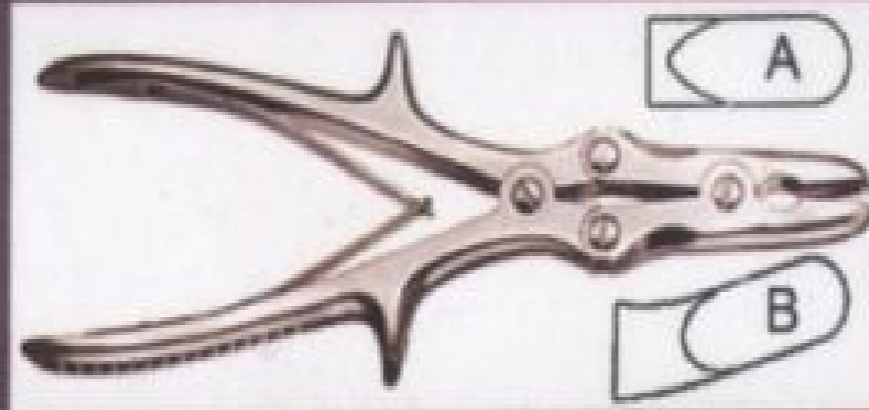

12-599-22 A / B Stille-Luer Bone Rongeur 22.5 cm / 8 3/4"

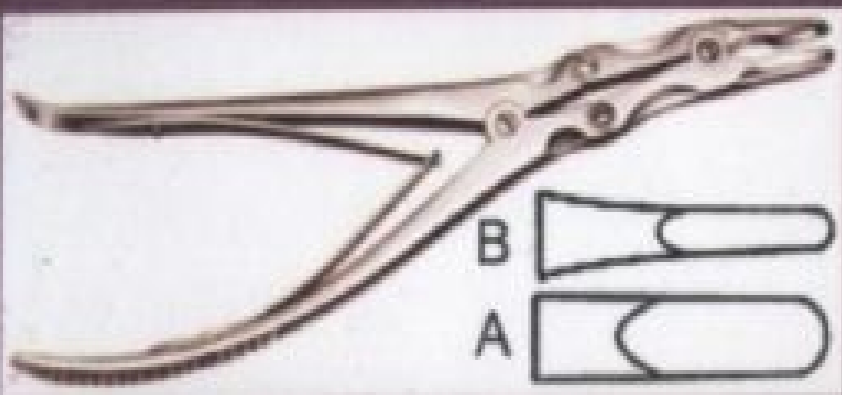

12-597-24 A / B Leksell-Stille Bone Rongeur 24.5 cm / 9 3/4"

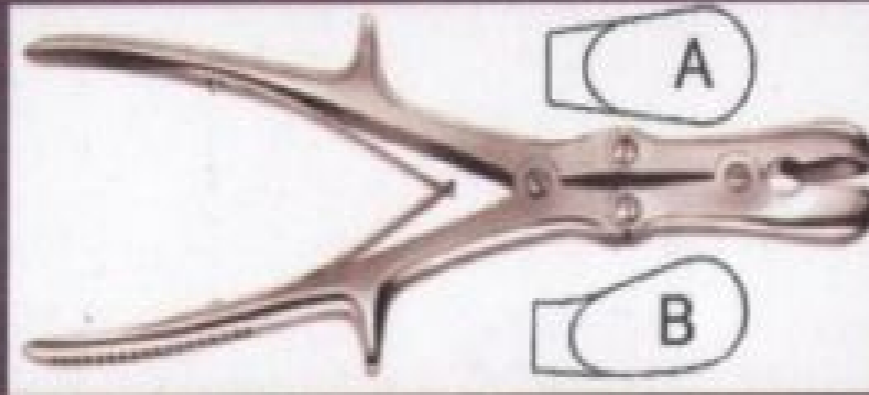

12-600-23 A / B Stille-Luer Bone Rongeur 23 cm / 9" & 26.5 cm / 10 1/2"

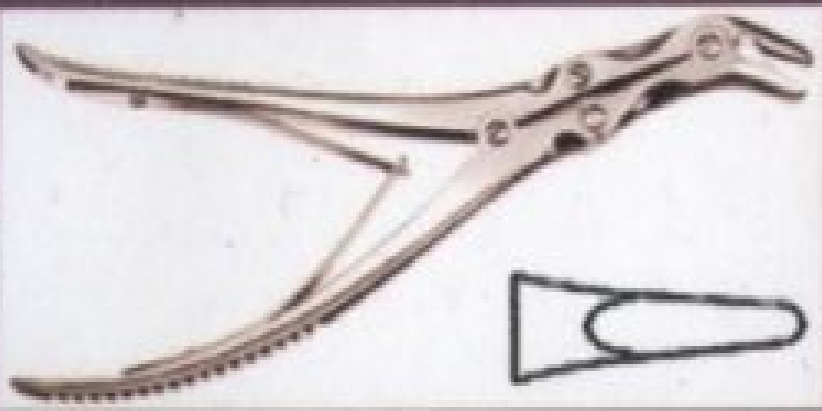

12-598-24 Frykholm Bone Rongeur 24.5 cm / 9 3/4"

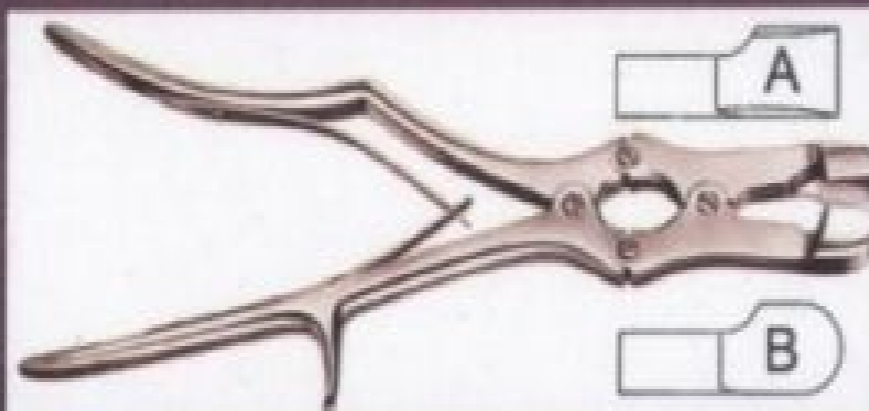

12-601-31 A / B Sauerbruch Bone Rongeur 31 cm / 12 1/4"



12-270-19 Lucae Mallet 19.5cm / 7 3/4"

Available in 2 sizes

19mm Ø / 230 gms
25mm Ø / 260 gms



12-275-19 Cottle Mallet Plane / Convex

19cm / 7 1/2" 30mm Ø / 300 gms

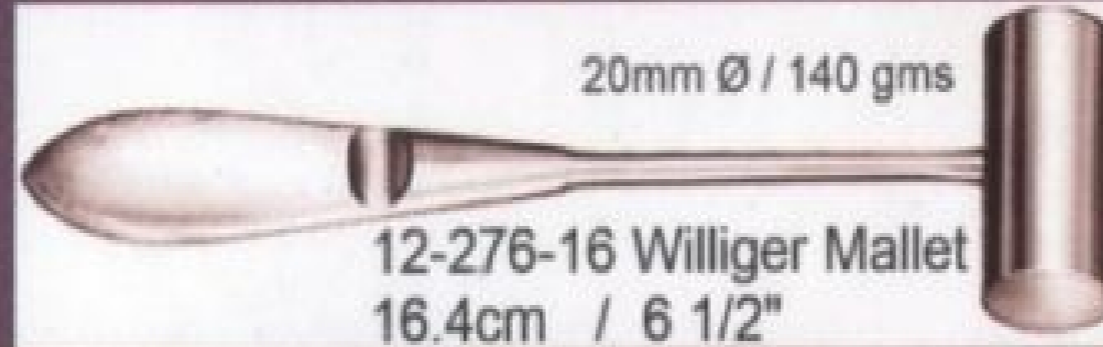

12-276-16 Williger Mallet 16.4cm / 6 1/2"

20mm Ø / 140 gms



12-278-26 Mallet 26 cm / 10 1/4"

plastic handle

30mm Ø / 510 gms



12-280-19 Mead Mallet 19 cm / 7 1/2"

with interchangeable plastic disks

27mm Ø / 320 gms



12-284-19 Partsch Mallet

22mm Ø / 200 gms

19 cm / 7 1/2" with hollow handle



12-290-26 Mallet 26 cm / 10 1/4" made of plastic with lead filling

Also available without lead filling

42mm Ø / 400 gms



12-292-26 Mallet 26 cm / 10 1/4"

made of plastic without lead filling

42mm Ø / 400 gms



12-294-26 Mallet 26.5 cm / 10 1/2" 30mm Ø / 675 gms

plane (nylon) / convex (steel) plastic handle



12-296-26 Mallet 26 cm / 10 1/4" plastic handle

42 / 30mm Ø / 530 gms



12-298-24 Mallet 24 cm / 9 1/2" plastic handle

30mm Ø / 480 gms



12-300-24 Mallet 24 cm / 9 1/2" Disks and handle of Plastic

37mm Ø / 370 gms

Spare facings (Pair)



30mm Ø / 125 gms

12-302-22 Mallet 22 cm / 8 3/4" Made of Plastic



12-306-26 Mallet 26.5 cm / 10 1/2" plastic handle

30mm Ø / 450 gms

Mallets

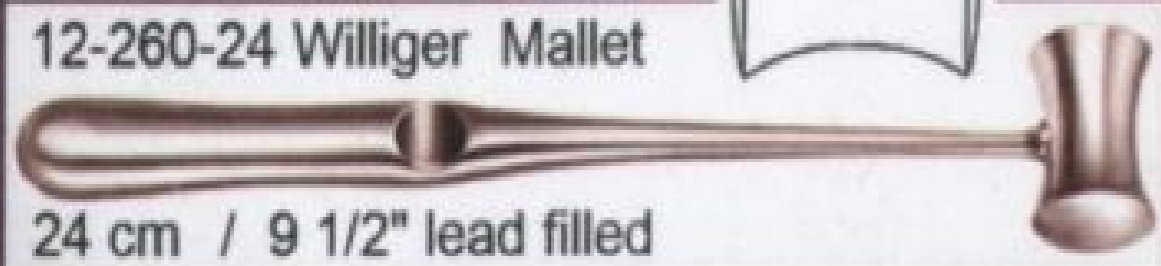

12-260-24 Williger Mallet

24 cm / 9 1/2" lead filled

Available Head Sizes & Approximate Weight
26mm Ø / 300 gms 28mm Ø / 340 gms
30mm Ø / 400 gms

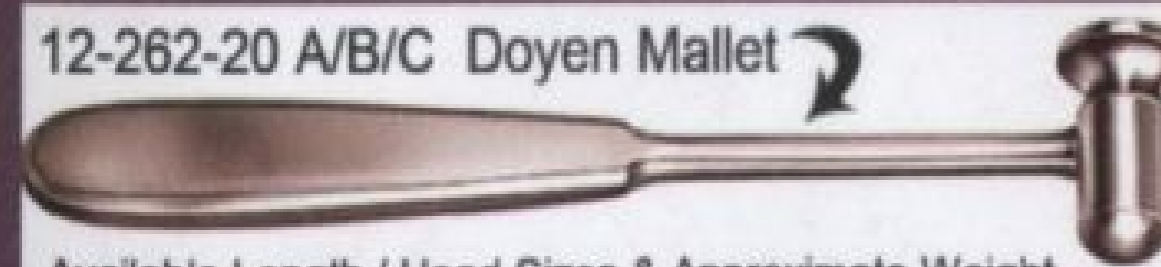

12-262-20 A/B/C Doyen Mallet

Available Length / Head Sizes & Approximate Weight

A: 20.5cm / 8" 25mm Ø / 120 gms
B: 21cm / 8 1/4" 30mm Ø / 180 gms
C: 21.5cm / 8 1/2" 35mm Ø / 260 gms



Head size / approximate weight
23mm Ø / 220 gms

12-264-20 Collin Mallet 20cm / 8"

Mallets

12-307-26 Mallet
26.5 cm / 10 1/2"



plastic handle 50mm Ø / 900 gms

12-310-19 Vickers Mallet
19 cm / 7 1/2"



nylon disks plastic handle 25mm Ø / 300 gms



Spare Facings

12-312-19 Herbert Mallet
19 cm / 7 1/2"



for ulnar head prosthesis plastic handle

Meniscotomes & Tendon Supporting

C: Left Bend B: Right Bend



12-494-17 A / B / C Smillie Meniscus Knife 17.5 cm / 7" A: Flat

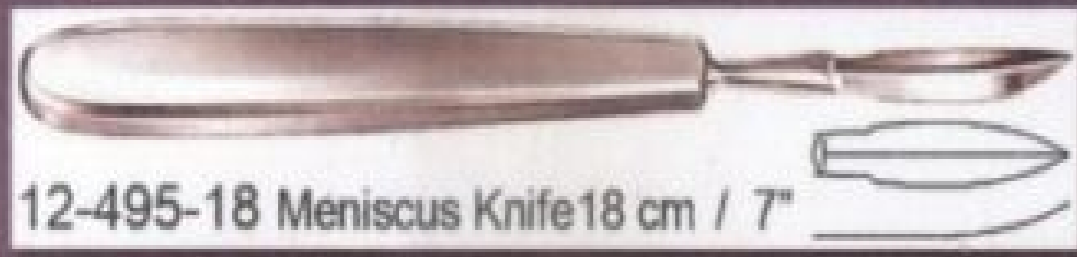

12-495-18 Meniscus Knife 18 cm / 7"



12-496-22 A / B Neff Meniscus Knife 22 cm / 8 3/4"

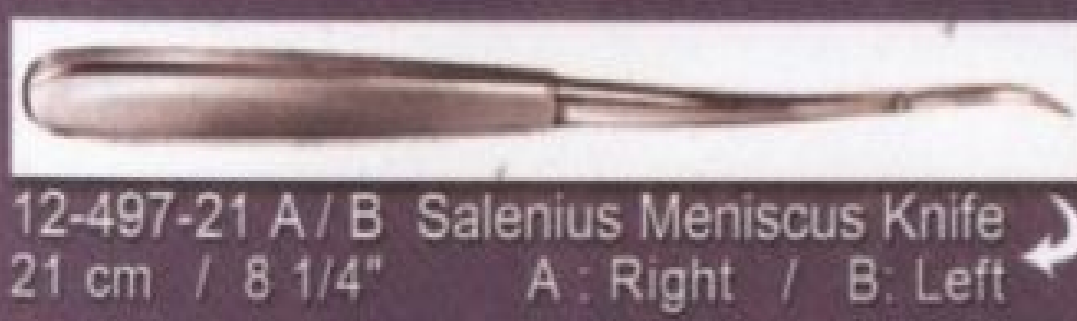

12-497-21 A / B Salenius Meniscus Knife 21 cm / 8 1/4" A: Right / B: Left



12-500-15 Bunnell Tendon Stripper 15 cm / 6" A B C D E



12-501-23 Tendon Stripper 23 cm / 9" Flexible shaft A B C

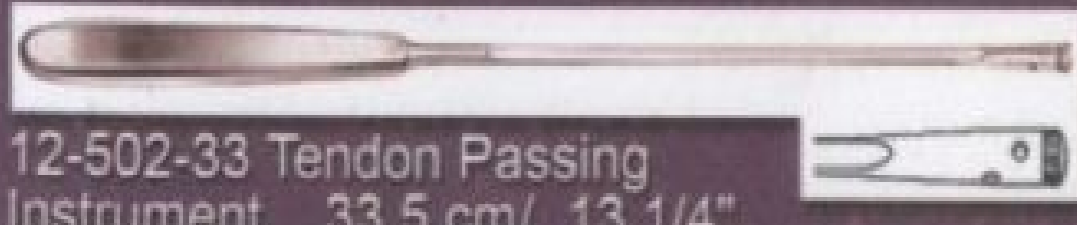

12-502-33 Tendon Passing Instrument 33.5 cm / 13 1/4"



12-503-31 Fischer Tendon Stripper 31 cm / 12 1/4" blunt



12-504-28 Tendon Stripper 28.5 cm / 11 1/4"

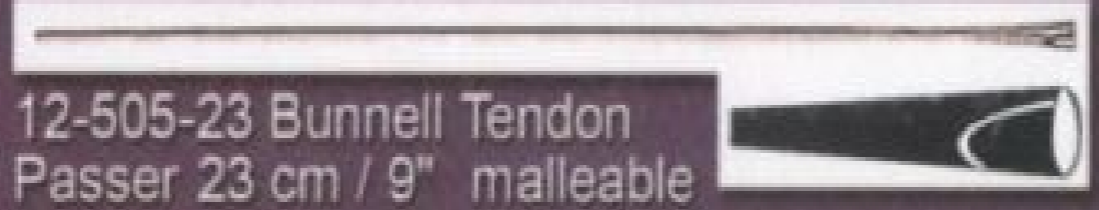

12-505-23 Bunnell Tendon Passer 23 cm / 9" malleable

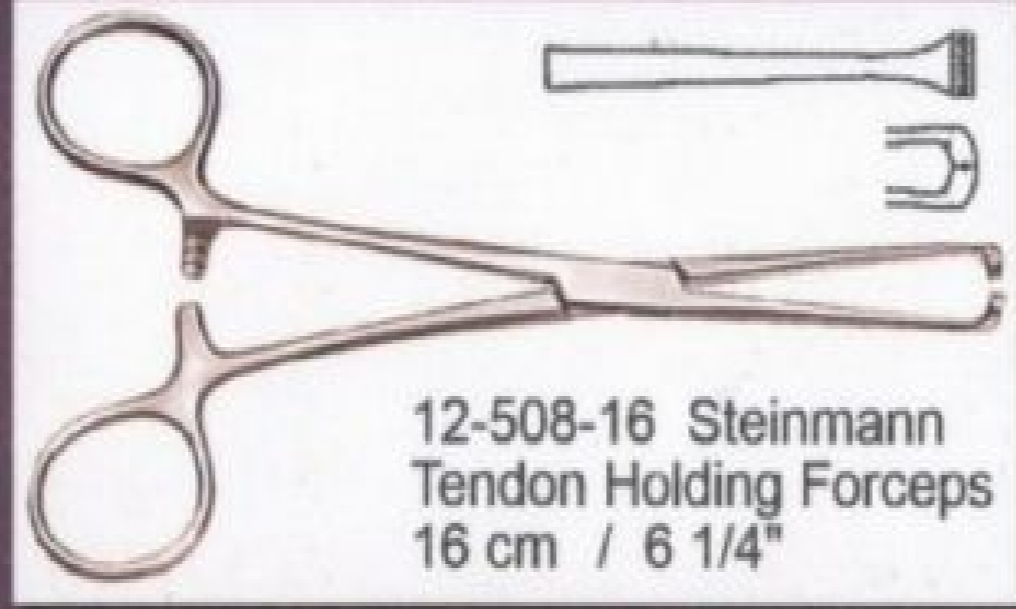

12-508-16 Steinmann Tendon Holding Forceps 16 cm / 6 1/4"

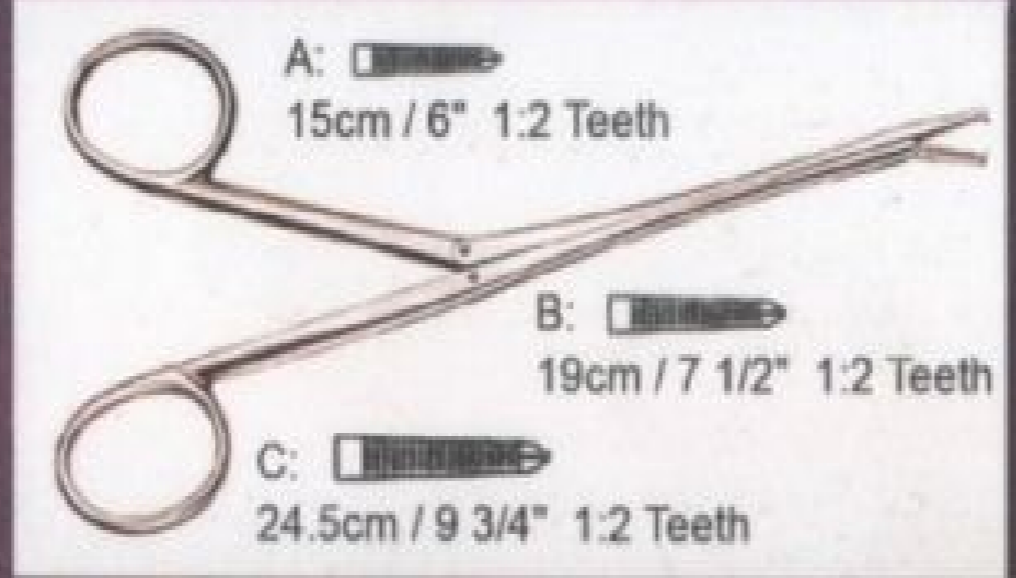

12-510-00 A / B / C Brand Tendon Tunnelling Forceps

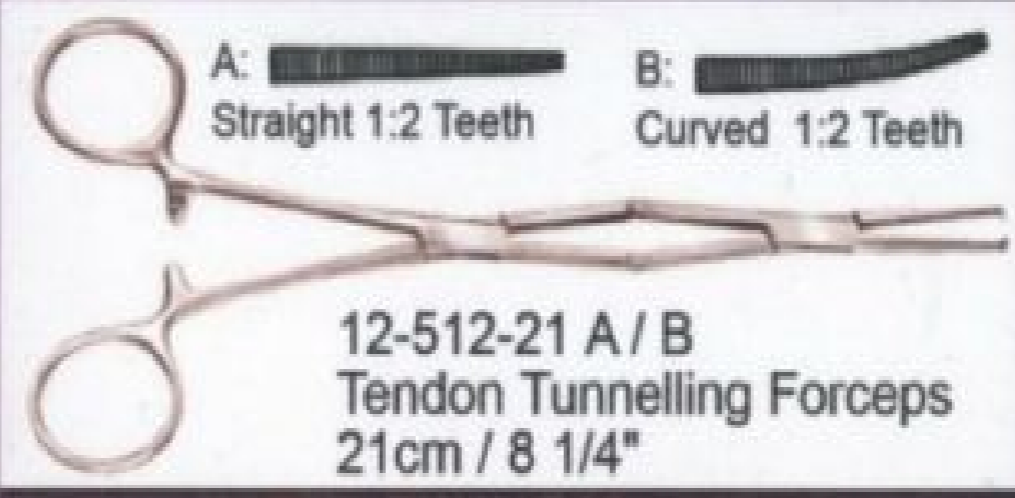

A: Straight 1:2 Teeth B: Curved 1:2 Teeth

12-512-21 A / B Tendon Tunnelling Forceps 21cm / 8 1/4"

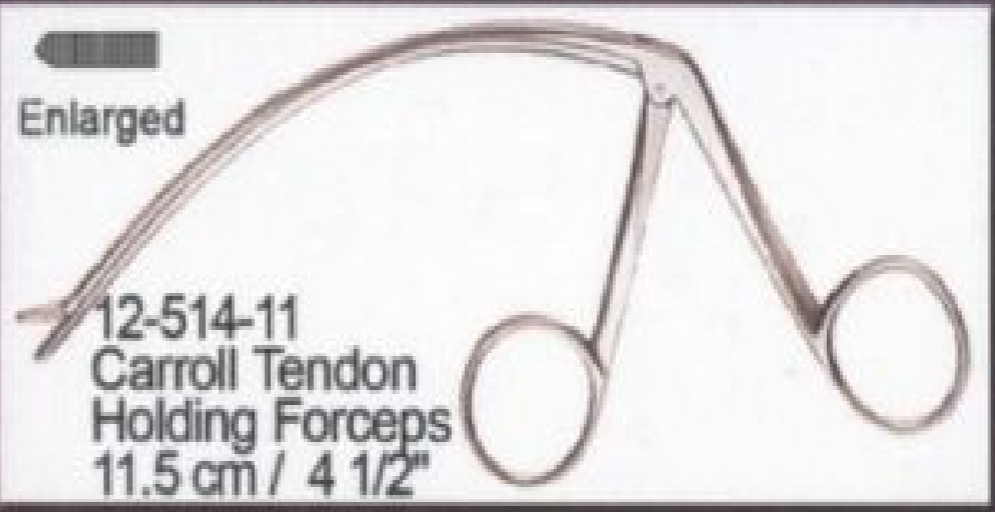

Enlarged

12-514-11 Carroll Tendon Holding Forceps 11.5 cm / 4 1/2"

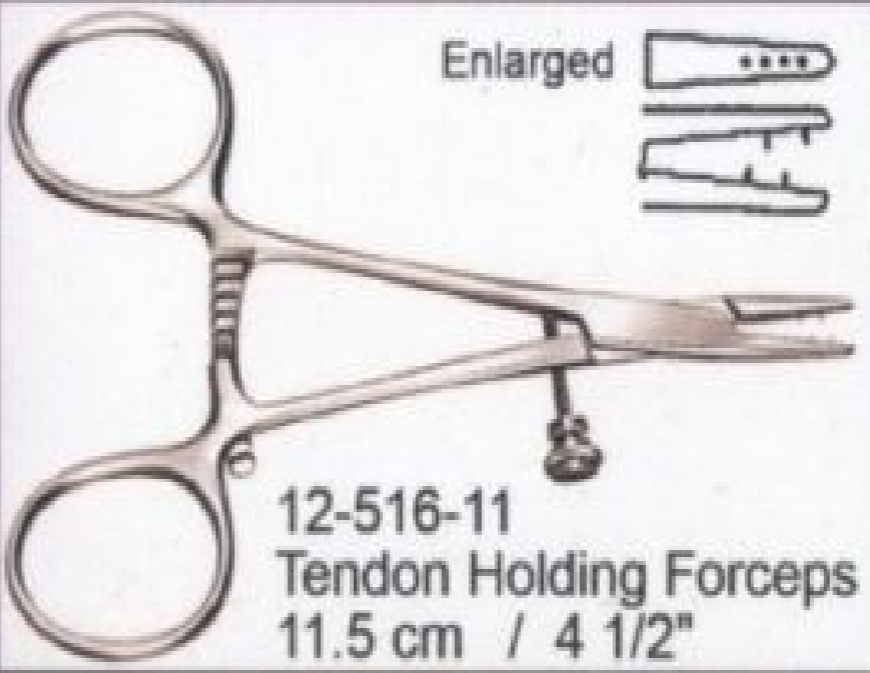

Enlarged

12-516-11 Tendon Holding Forceps 11.5 cm / 4 1/2"

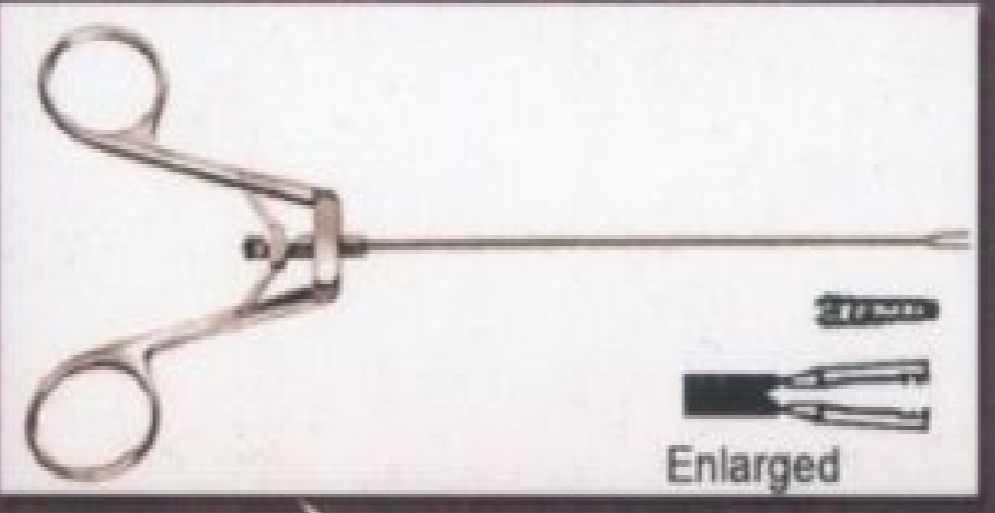

Enlarged

12-518-21 Kleinert-Kutz Tendon Holding Forceps 21 cm / 8 1/4" 1:2 teeth



Enlarged

12-520-15 Tendon Interlacing Forceps 15.5 cm / 6" pointed



Enlarged

12-521-15 Tendon Interlacing Forceps 15.5 cm / 6" pointed

TC (Tungston Carbide Inserts) / GOLD Instruments

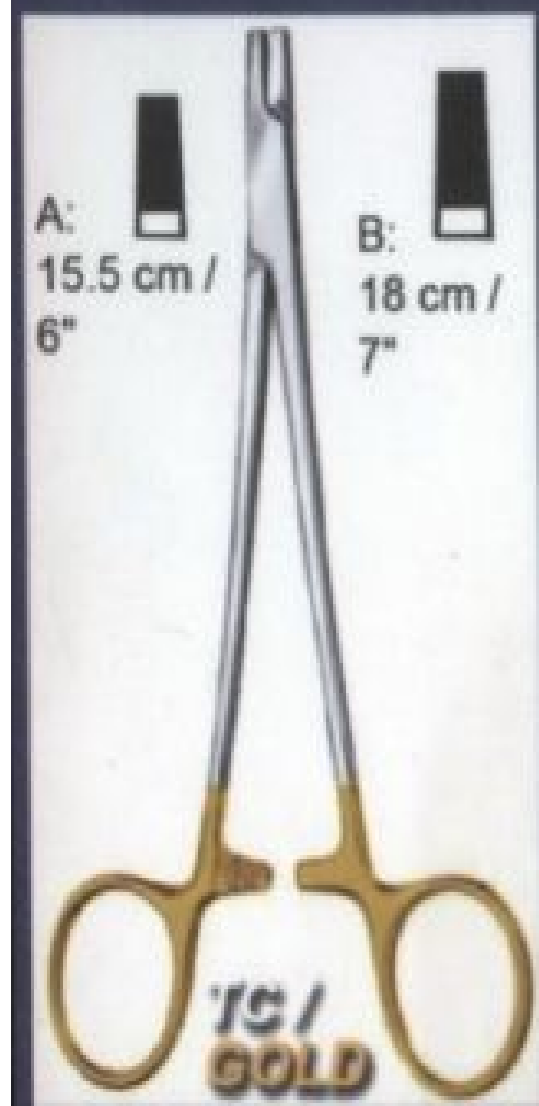

TC-01-15 A / B
Wire Twisting
Forceps



TC-02-15 A / B
Wire Twisting
Forceps

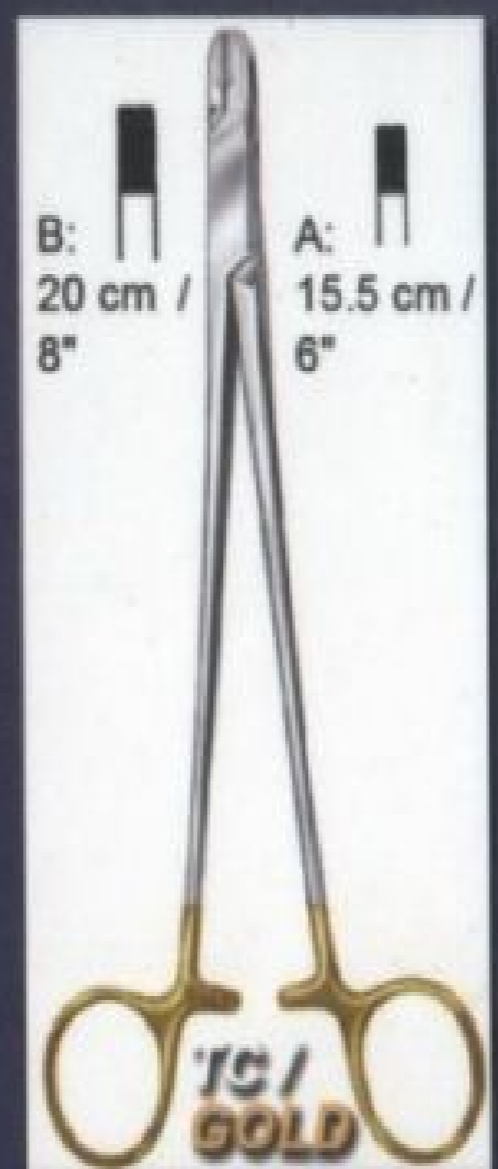

TC-03-15 A / B
Wire Twisting
Forceps



TC-06-15
Wire Twisting Forceps
15.5 cm / 6"

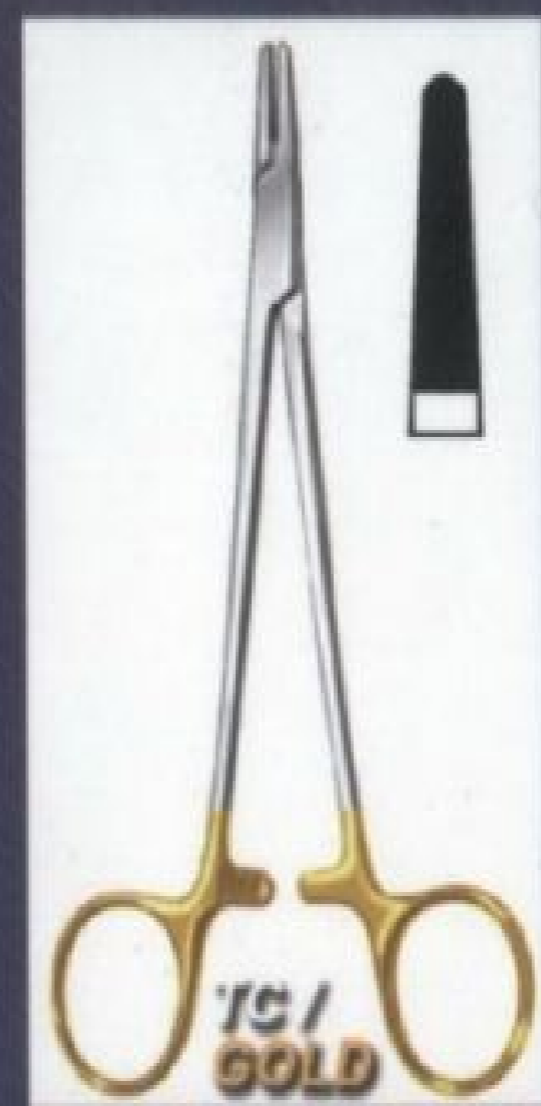

TC-08-16 Corwin
Wire Twisting Forceps
16 cm / 6 1/4"



TC-08-18 Corwin
Combi-Wire Twisting
Forceps
18.5 cm / 7 1/4"

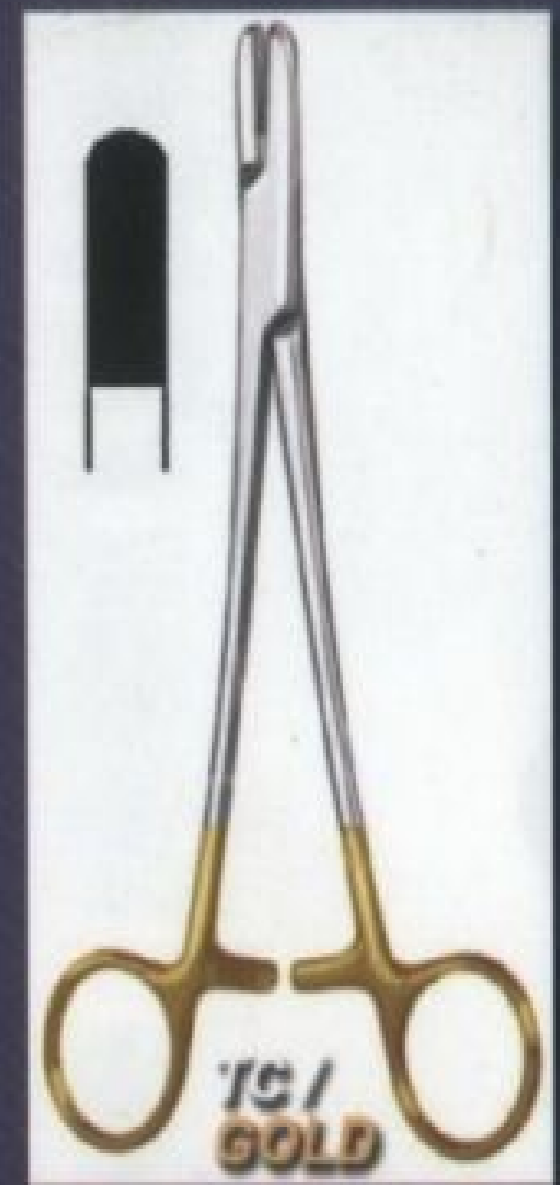

TC-10-19 Wire Twisting
Forceps heavy pattern
19 cm / 7 1/2"

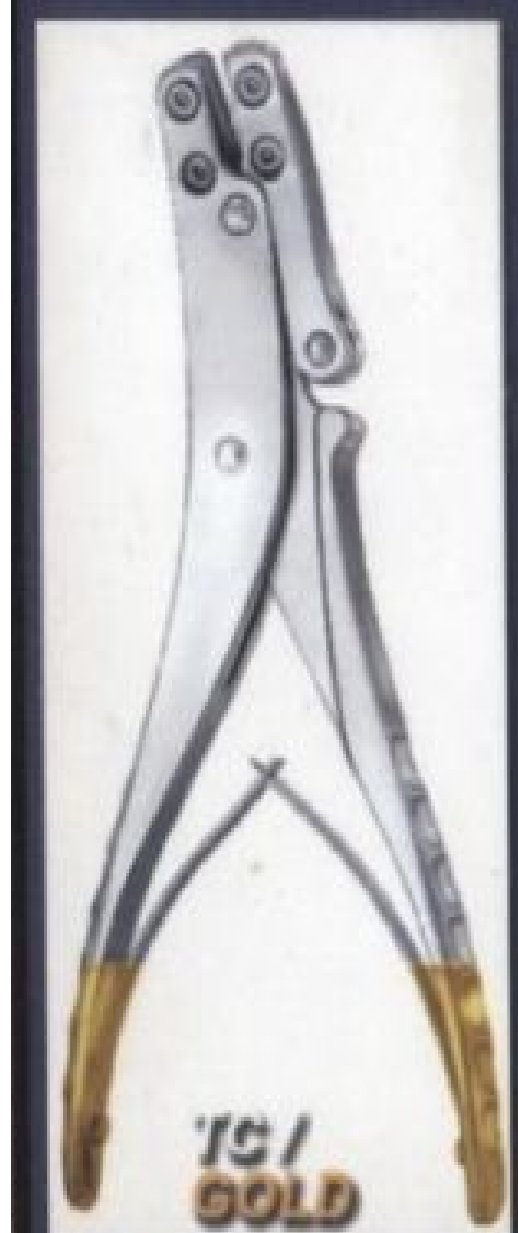

TC-14-17 Martin
"Gigant-Compact"
Wire Cutting Pliers
17.5 cm / 7" For hard
wires upto 2.2mm Ø

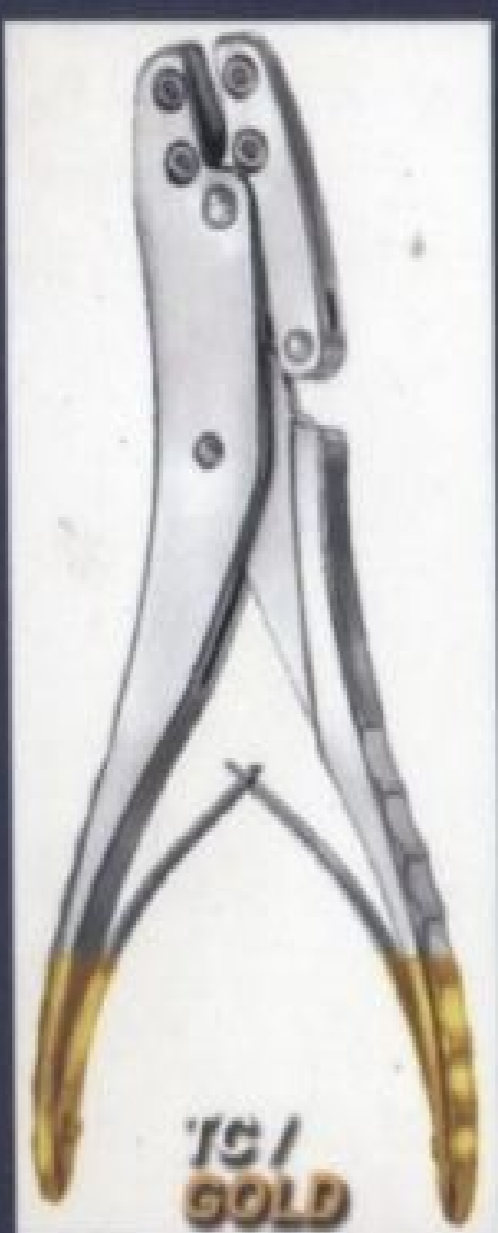

TC-15-17 Martin
"Gigant-Compact"
Wire Cutting Pliers
17 cm / 6 3/4" For hard
wires upto 3.0mm Ø



TC-16-17 Martin
"Gigant-Compact"
Wire Cutting Pliers
17 cm / 6 3/4"
For soft wires upto 2.0mm Ø
For hard wires upto 1.7mm Ø



TC-17-22 Martin
"Gigant-Compact"
Wire Cutting Pliers
22.5 cm / 8 3/4"
For soft wires upto 2.8mm Ø
For hard wires upto 2.2mm Ø



TC-18-15
Wire Cutting Pliers
15 cm / 6"
For soft wires upto 2.0mm Ø
For hard wires upto 1.2mm Ø



TC-19-17
Wire Cutting Pliers
17.5 cm / 7"
For soft wires upto 2.0mm Ø
For hard wires upto 1.5mm Ø

